

### GENERAL DESCRIPTION

The μPC272/319 are precision high speed dual comparators designed to operate over a wide range of supply voltage down to a 5 V logic supply and ground. Further advantage, they have excellent input characteristics and direct drive capability to all the popular logic families.

Two kinds of ICs are available according to the reliability, the μPC272 for industry, the μPC319 for commercial.

### FEATURES

- Operate from Single 5 V Supply
- Typically 80 ns Response Time at ±15 V
- Open Collector Output
- Minimum Fan-Out of 2 Each Side (TTL)
- High Common Mode Slew Rate
- LM319 Direct Replacement

### EQUIVALENT CIRCUIT

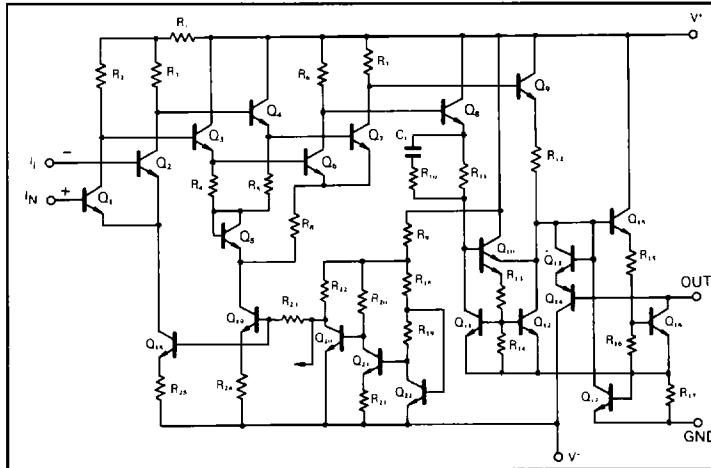

### CONNECTION DIAGRAM (Top View)

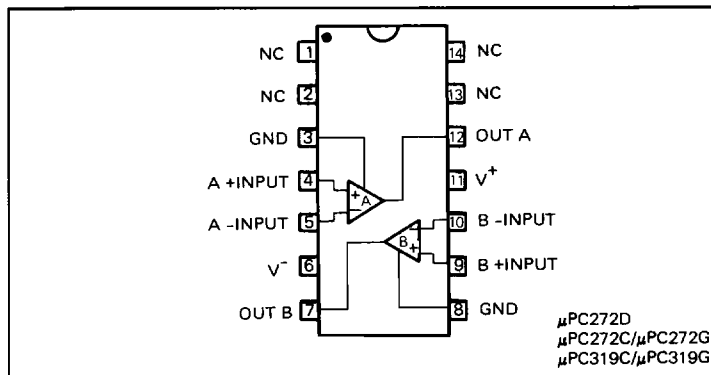

### ORDERING INFORMATION

μPC272D



14 pin Ceramic DIP  
(Dual In-Line Package)

μPC272C/μPC319C

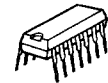

14 pin Plastic Molded DIP  
(Dual In-Line Package)

μPC272G/μPC319G



14 pin Plastic Molded Flat Package  
(MINI FLAT IC)

**ABSOLUTE MAXIMUM RATINGS (Ta = 25°C)**

PARAMETER		μPC272	μPC319	UNIT
Voltage between V <sup>+</sup> and V <sup>-</sup>		36	36	V
Output to Negative Supply Voltage		36	36	V
Ground to Negative Supply Voltage		25	25	V
Ground to Positive Supply Voltage		18	18	V
Differential Input Voltage		±5	±5	V
Input Voltage (Note 1)		±15	±15	V
Power Dissipation *	D Package	900	—	mW
	C Package	500	500	
	G Package	550	550	
Output Short Circuit Duration		10	10	s
Operating Temperature Range	D Package	-20 to +80	—	°C
	C or G Package	-20 to +70	0 to 70	
Storage Temperature Range	D Package	-55 to +150	—	°C
	C or G Package	-55 to +125	-55 to +125	

Note 1. For supply voltages less than ±15 V, the absolute maximum input voltage is equal to the supply voltage.

\* See thermal information in chapter 11.

**ELECTRICAL CHARACTERISTICS (V<sup>±</sup> = ±15 V, Ta = 25°C)**

CHARACTERISTIC	MIN.	TYP.	MAX.	UNITS	CONDITIONS
Input Offset Voltage		2.0	8.0	mV	V <sup>±</sup> = ±5 V ~ ±15 V, R <sub>s</sub> ≤ 50 kΩ
Input Offset Current		80	200	nA	"
Input Bias Current		400	1 000	nA	"
Voltage Gain	8	40		V/mV	
Response Time		80		ns	Input 100 mV, Overdrive 5 mV
Saturation Voltage		0.75	1.5	V	V <sub>IN</sub> ≤ -10 mV, I <sub>o</sub> = 25 mA
Output Leakage Current		0.2	10	μA	V <sub>IN</sub> ≥ 10 mV, V <sub>o</sub> = 35 V
Positive Supply Current		4.3		mA	V <sup>+</sup> = +5 V, V <sup>-</sup> = 0V
Positive Supply Current		8.0	12.5	mA	V <sup>±</sup> = ±15 V
Positive Supply Current		3.0	5.0	mA	V <sup>±</sup> = ±5V
Input Offset Voltage			10	mV	V <sup>±</sup> = ±5 V ~ ±15 V, R <sub>s</sub> ≤ 5 kΩ, Ta = 0 ~ +70°C
Input Offset Current			300	nA	"
Input Bias Current			1 200	nA	"
Input Voltage Range		±13		V	V <sup>±</sup> = ±15 V
Saturation Voltage		0.23	0.4	V	V <sup>+</sup> > 4.5 V, V <sup>-</sup> = 0 V, V <sub>IN</sub> ≤ -10 mV, I <sub>o</sub> ≤ 3.2 mA

Split Supplies

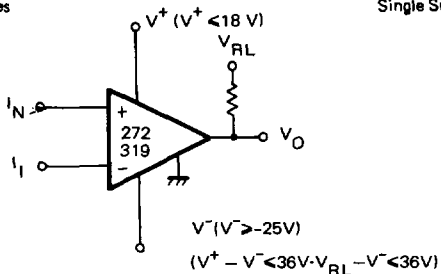

Single Supply

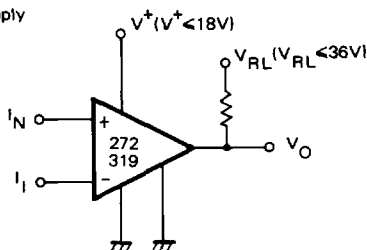

TYPICAL PERFORMANCE CHARACTERISTICS (T<sub>a</sub>=25 °C)

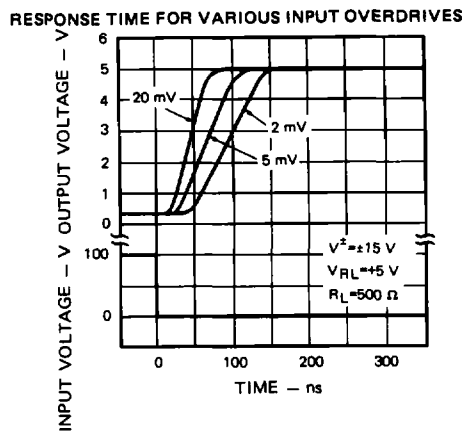
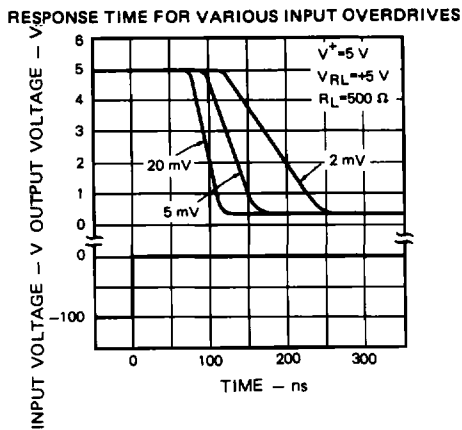
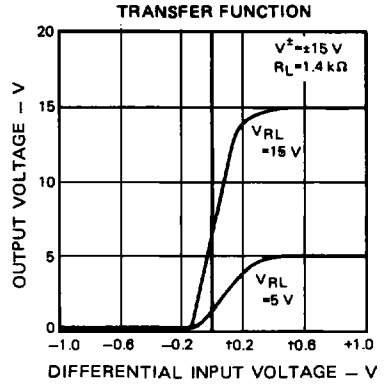
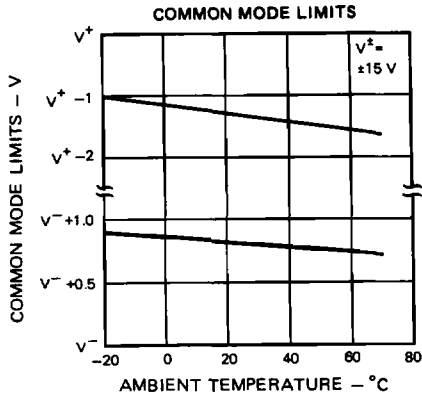
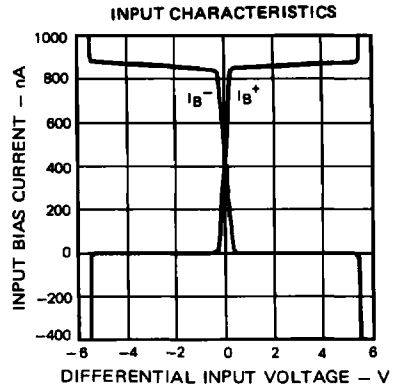
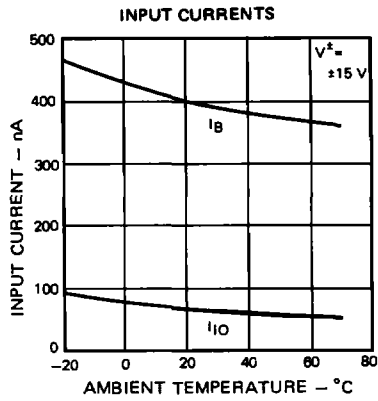

**RESPONSE TIME FOR VARIOUS INPUT OVERDRIVES**

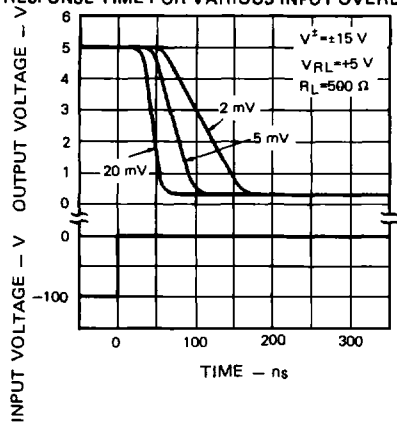

**RESPONSE TIME FOR VARIOUS INPUT OVERDRIVES**

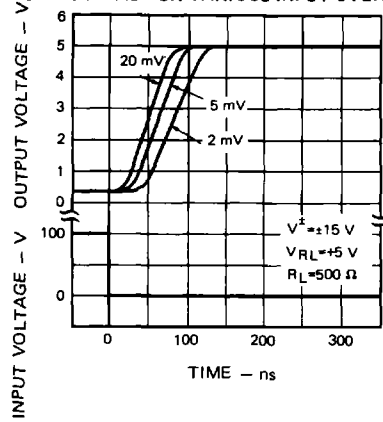

**OUTPUT SATURATION VOLTAGE**

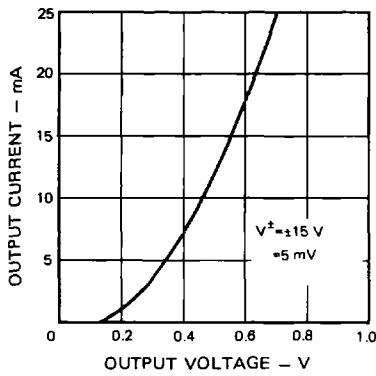

**OUTPUT LIMITING CHARACTERISTICS**

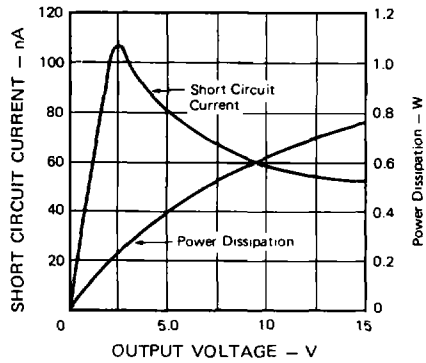

**SUPPLY CURRENT**

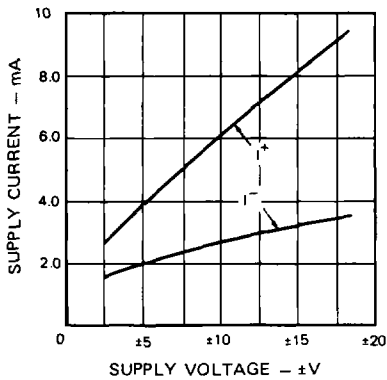

**SUPPLY CURRENT**

