

TOSHIBA BIPOLAR DIGITAL INTEGRATED CIRCUIT SILICON MONOLITHIC

TD62081AP, TD62081CP, TD62081F, TD62081AF, TD62082AP, TD62082CP
TD62082F, TD62082AF, TD62083AP, TD62083CP, TD62083F, TD62083AF
TD62084AP, TD62084CP, TD62084F, TD62084AF

8CH DARLINGTON SINK DRIVER

The TD62081AP / CP / F / AF Series are high-voltage, high-current darlington drivers comprised of eight NPN darlington pairs.

All units feature integral clamp diodes for switching inductive loads.

Applications include relay, hammer, lamp and display (LED) drivers.

FEATURES

- Output current (single output)
 500 mA (Max.) (TD62081AP / F / AF series)
 400 mA (Max.) (TD62081CP series)
- High sustaining voltage output
 35 V (Min.) (TD62081F series)
 50 V (Min.) (TD62081AP / AF series)
 100 V (Min.) (TD62081CP series)
- Output clamp diodes
- Inputs compatible with various types of logic.
- Package type-AP, CP: DIP-18 pin
- Package type-F, AF : SOP-18 pin

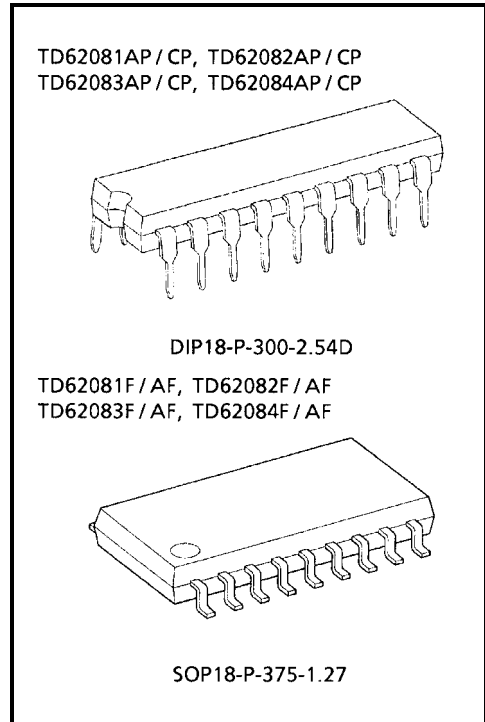

Weight
 DIP18-P-300-2.54D : 1.478 g (Typ.)
 SOP18-P-375-1.27 : 0.41 g (Typ.)

TYPE	INPUT BASE RESISTOR	DESIGNATION
TD62081AP / CP / F / AF	External	General Purpose
TD62082AP / CP / F / AF	10.5-kΩ + 7 V Zener diode	14~25 V PMOS
TD62083AP / CP / F / AF	2.7 kΩ	TTL, 5 V CMOS
TD62084AP / CP / F / AF	10.5 kΩ	6~15 V PMOS, CMOS

PIN CONNECTION (TOP VIEW)

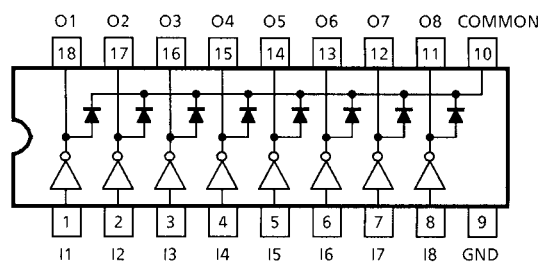

SCHEMATICS (EACH DRIVER)

TD62081AP / CP / F / AF

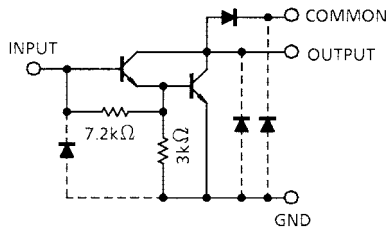

TD62082AP / CP / F / AF

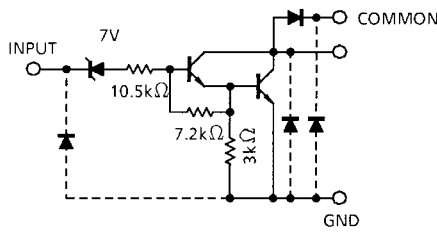

TD62083AP / CP / F / AF

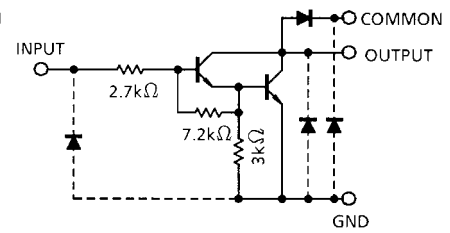

TD62084AP / CP / F / AF

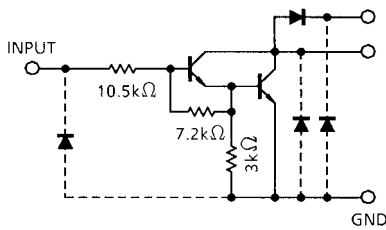

Note: The input and output parasitic diodes cannot be used as clamp diodes.

MAXIMUM RATINGS (Ta = 25°C)

CHARACTERISTIC		SYMBOL	RATING	UNIT
Output Sustaining Voltage	AP, AF	V _{CE (SUS)}	-0.5~50	V
	CP		-0.5~100	
	F		-0.5~35	
Output Current		I _{OUT}	500	mA / ch
	CP		400	
Input Voltage		V _{IN} (Note 1)	-0.5~30	V
Input Current		I _{IN} (Note 2)	25	mA
Clamp Diode Reverse Voltage	AP, AF	V _R	50	V
	CP		100	
	F		35	
Clamp Diode Forward Current		I _F	500	mA
	CP		400	
Power Dissipation	AP, CP	P _D	1.47	W
	F, AF		0.96	
Operating Temperature		T _{opr}	-40~85	°C
Storage Temperature		T _{stg}	-55~150	°C

Note 1: Except TD62081AP / CP / F / AF

Note 2: Only TD62081AP / CP / F / AF

RECOMMENDED OPERATING CONDITIONS (Ta = -40~85°C)

CHARACTERISTIC		SYMBOL	TEST CONDITION	MIN	TYP.	MAX	UNIT
Output Sustaining Voltage	AP, AF	V _{CE (SUS)}		0	—	50	V
	CP			0	—	100	
	F			0	—	35	
Output Current	AP, CP	I _{OUT}	T _{pw} = 25 ms, Duty = 10% 8 Circuits	0	—	347	mA / ch
			T _{pw} = 25 ms, Duty = 50% 8 Circuits	0	—	123	
	F, AF		T _{pw} = 25 ms, Duty = 10% 8 Circuits	0	—	268	
			T _{pw} = 25 ms, Duty = 50% 8 Circuits	0	—	90	
Input Voltage	Except TD62081AP / CP / F / AF	V _{IN}		0	—	30	V
Input Voltage (Output On)	TD62082AP / CP / F / AF	V _{IN (ON)}		14	—	30	V
	TD62083AP / CP / F / AF			3.5	—	30	
	TD62084AP / CP / F / AF			8	—	30	
Input Voltage (Output Off)	TD62082AP / CP / F / AF	V _{IN (OFF)}		0	—	7.4	V
	TD62083AP / CP / F / AF			0	—	0.5	
	TD62084AP / CP / F / AF			0	—	1.0	
Input Current	Only TD62081AP / CP / F / AF	I _{IN}		0	—	5	mA
Clamp Diode Reverse Voltage	AP, AF	V _R		—	—	50	V
	CP			—	—	100	
	F			—	—	35	
Clamp Diode Forward Current		I _F		—	—	400	mA
	CP			—	—	320	
Power Dissipation	AP, CP	P _D		—	—	0.52	W
	F, AF			—	—	0.4	

ELECTRICAL CHARACTERISTICS (Ta = 25°C)

CHARACTERISTIC		SYMBOL	TEST CIR-CUIT	TEST CONDITION	MIN	TYP.	MAX	UNIT								
Output Leakage Current	AP, AF CP F	I _{CEX}	1	V _{CE} = 50 V	—	—	50	μA								
				V _{CE} = 100 V					Ta = 25°C							
				V _{CE} = 35 V												
	AP, AF CP F			I _{CEX}	1	V _{CE} = 50 V	—		—	100	μA					
						V _{CE} = 100 V						Ta = 85°C				
						V _{CE} = 35 V										
	TD62082 AP, AF CP F			I _{CEX}		1	V _{CE} = 50 V		—	—		500	μA			
							V _{CE} = 100 V							V _{IN} = 6 V		
							V _{CE} = 35 V									
	TD62084 AP, AF CP F			I _{CEX}			1		V _{CE} = 50 V	—		—		500	μA	
									V _{CE} = 100 V							V _{IN} = 1 V
									V _{CE} = 35 V							
Collector-Emitter Saturation Voltage		V _{CE (sat)}	2	I _{OUT} = 350 mA, I _{IN} = 500 μA				—	1.3	1.6		V				
				I _{OUT} = 200 mA, I _{IN} = 350 μA				—	1.1	1.3						
				I _{OUT} = 100 mA, I _{IN} = 250 μA				—	0.9	1.1						
Input Current	TD62082AP / CP / F / AF	I _{IN (ON)}	2	V _{IN} = 17 V	—			0.82	1.25	mA						
	TD62083AP / CP / F / AF			V _{IN} = 3.85 V	—			0.93	1.35							
	TD62084AP / CP / F / AF			V _{IN} = 5 V	—			0.35	0.5							
				V _{IN} = 12 V	—	1.0		1.45								
			I _{IN (OFF)}	4	I _{OUT} = 500 μA, Ta = 85°C	50		65	—	μA						
Input Voltage (Output On)	TD62082AP / CP / F / AF	V _{IN (ON)}	5	V _{CE} = 2 V, I _{OUT} = 300 mA	—	—		13	V							
				V _{CE} = 2 V, I _{OUT} = 200 mA	—	—	2.4									
				V _{CE} = 2 V, I _{OUT} = 250 mA	—	—	2.7									
	TD62083AP / CP / F / AF			V _{CE} = 2 V, I _{OUT} = 300 mA	—	—	3.0									
				V _{CE} = 2 V, I _{OUT} = 125 mA	—	—	5.0									
	TD62084AP / CP / F / AF			V _{CE} = 2 V, I _{OUT} = 200 mA	—	—	6.0									
				V _{CE} = 2 V, I _{OUT} = 275 mA	—	—	7.0									
				V _{CE} = 2 V, I _{OUT} = 350 mA	—	—	8.0									
DC Current Transfer Ratio		h _{FE}	2	V _{CE} = 2 V, I _{OUT} = 350 mA	1000	—	—									
Clamp Diode Reverse Current		I _R	6	Ta = 25°C (Note)	—	—	50	μA								
				Ta = 85°C (Note)	—	—	100									
Clamp Diode Forward Voltage	CP	V _F	7	I _F = 350 mA	—	—	2.0	V								
				I _F = 280 mA	—	—	1.8									
Input Capacitance		C _{IN}	—		—	15	—	pF								

Note: V_R = V_R MAX.

CHARACTERISTIC		SYMBOL	TEST CIR-CUIT	TEST CONDITION	MIN	TYP.	MAX	UNIT
Turn-On Delay	AP, AF	t_{ON}	8	$R_L = 125 \Omega, V_{OUT} = 50 V$	—	0.1	—	μA
	CP			$R_L = 312 \Omega, V_{OUT} = 100 V$	—	0.1	—	
	F			$R_L = 87.5 \Omega, V_{OUT} = 35 V$	—	0.1	—	
Turn-Off Delay	AP, AF	t_{OFF}		$R_L = 125 \Omega, V_{OUT} = 50 V$	—	0.2	—	
	CP			$R_L = 312 \Omega, V_{OUT} = 100 V$	—	3.0	—	
	F			$R_L = 87.5 \Omega, V_{OUT} = 35 V$	—	0.2	—	

TEST CIRCUIT

1. I_{CEX}

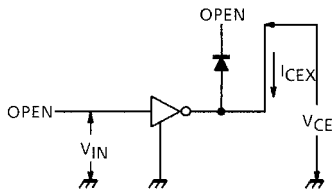

2. $V_{CE} (sat), h_{FE}$

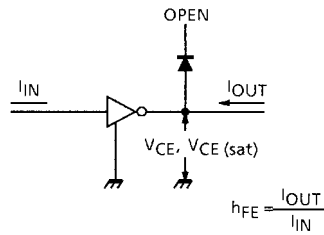

3. $I_{IN} (ON)$

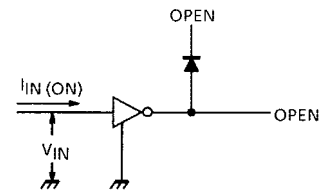

4. $I_{IN} (OFF)$

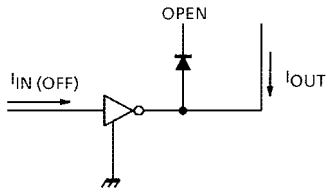

5. $V_{IN} (ON)$

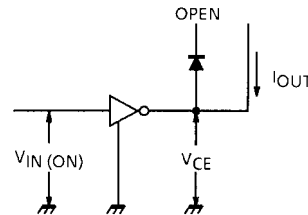

6. I_R

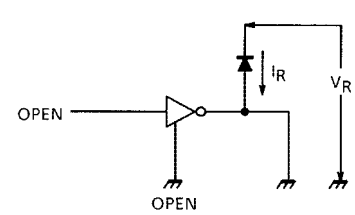

7. V_F

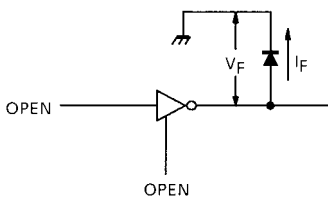

8. t_{ON} , t_{OFF}

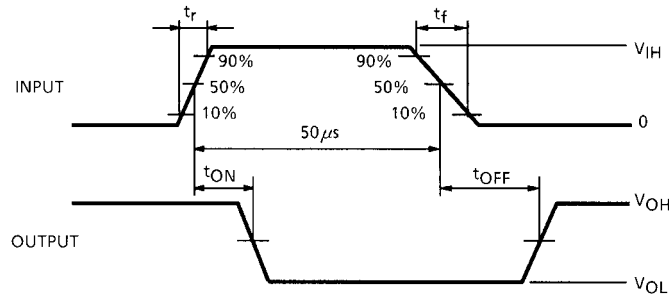
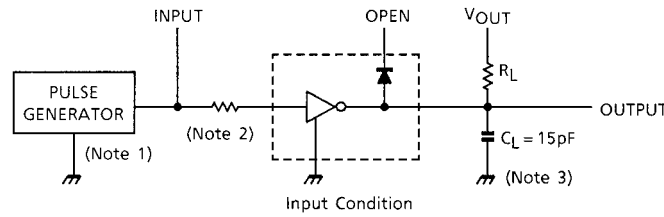

Note 1: Pulse Width 50 μ s, Duty Cycle 10%
Output Impedance 50 Ω , $t_r \leq 5$ ns, $t_f \leq 10$ ns

Note 2: See below.

INPUT CONDITION

TYPE NUMBER	R1	V_{IH}
TD62081AP / CP / F / AF	2.7 k Ω	3 V
TD62082AP / CP / F / AF	0 Ω	13 V
TD62083AP / CP / F / AF	0 Ω	3 V
TD62084AP / CP / F / AF	0 Ω	8 V

Note 3: C_L includes probe and jig capacitance

PRECAUTIONS for USING

This IC does not include built-in protection circuits for excess current or overvoltage.

If this IC is subjected to excess current or overvoltage, it may be destroyed.

Hence, the utmost care must be taken when systems which incorporate this IC are designed.

Utmost care is necessary in the design of the output line, COMMON and GND line since IC may be destroyed due to short-circuit between outputs, air contamination fault, or fault by improper grounding.

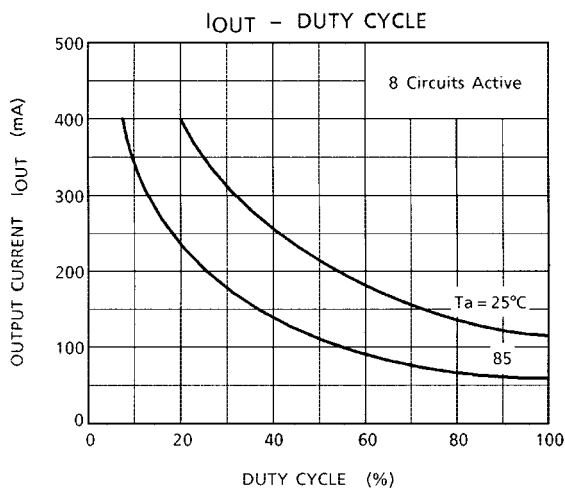
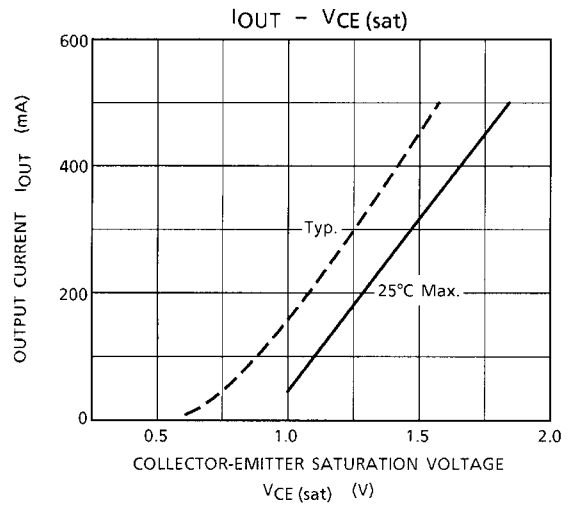
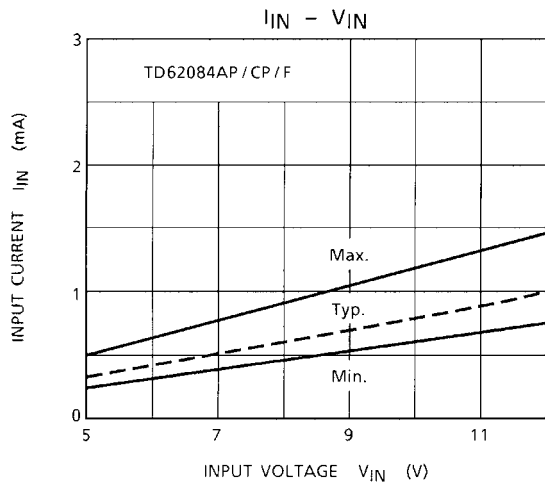
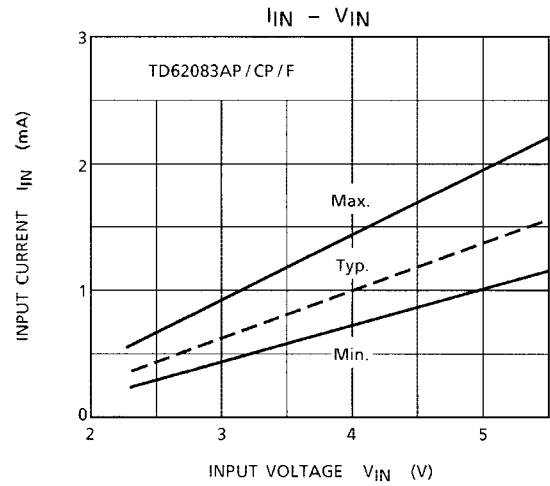
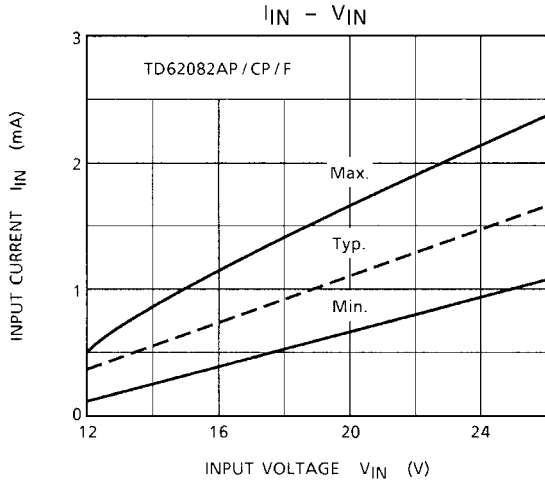

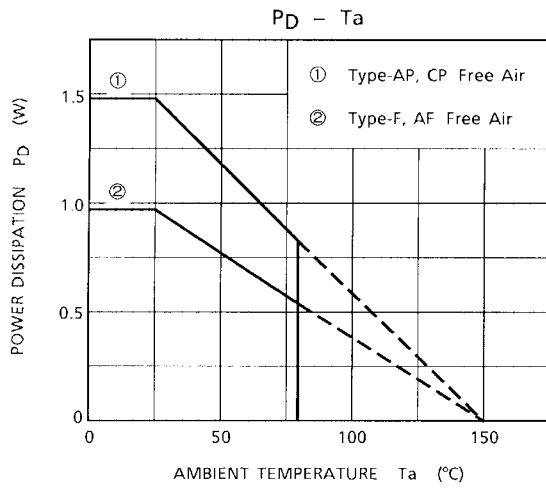
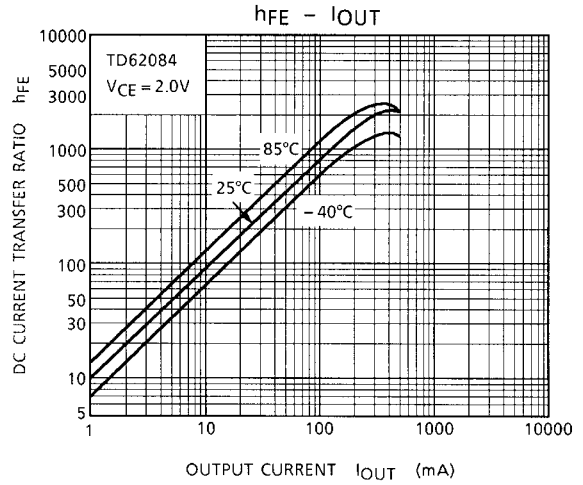
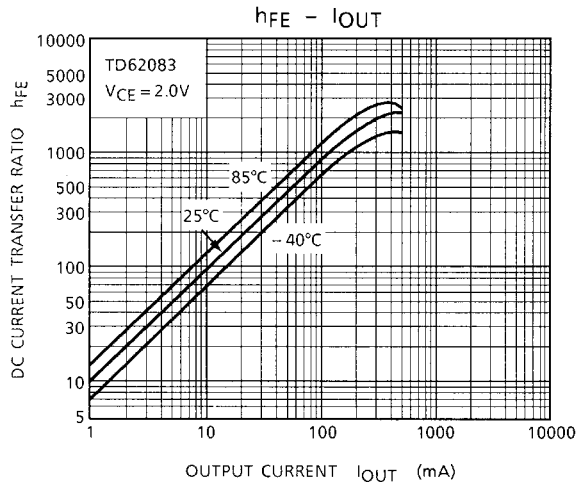

PACKAGE DIMENSIONS

DIP18-P-300-2.54D

Unit : mm

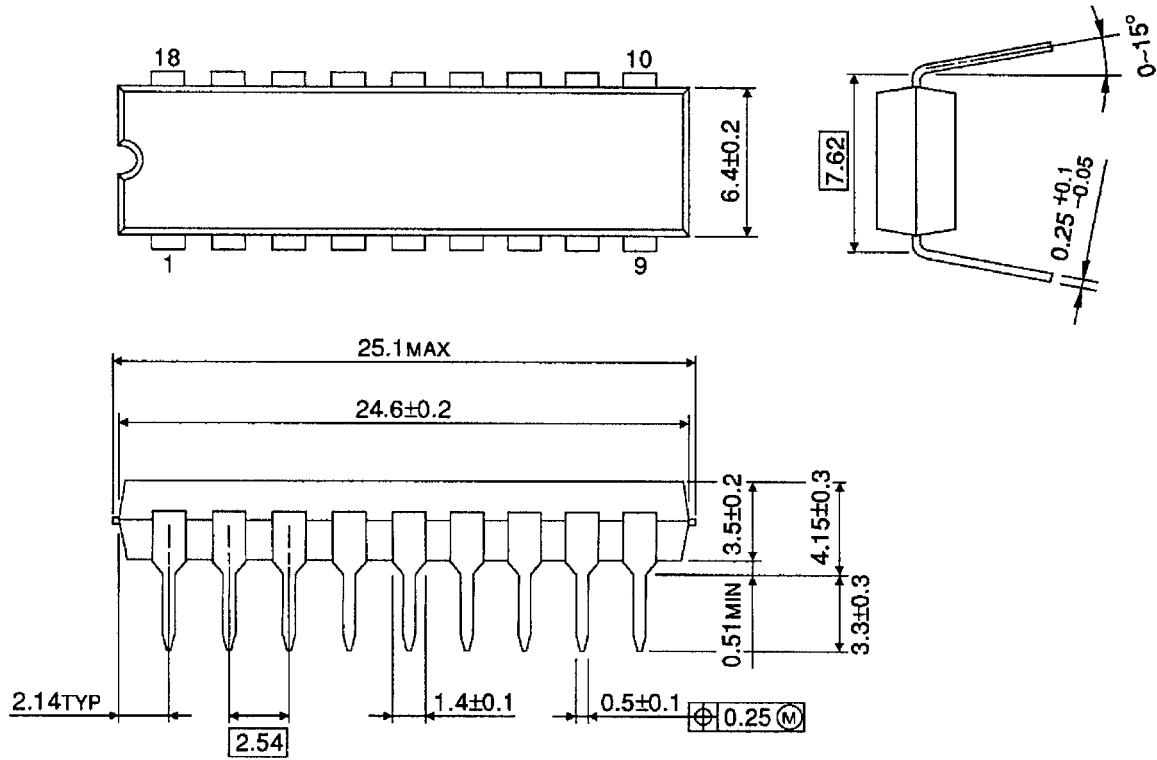

Weight: 1.478 g (Typ.)

PACKAGE DIMENSIONS

SOP18-P-375-1.27

Unit : mm

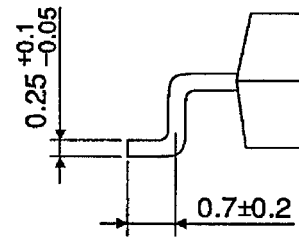
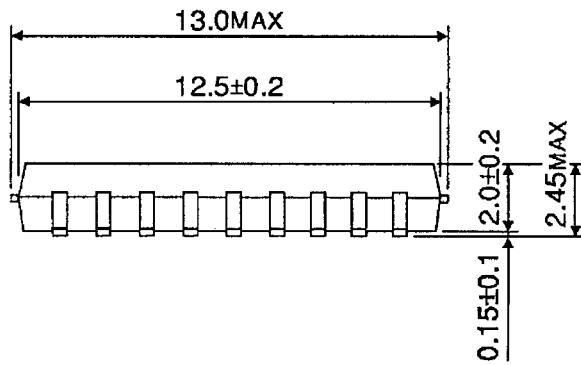
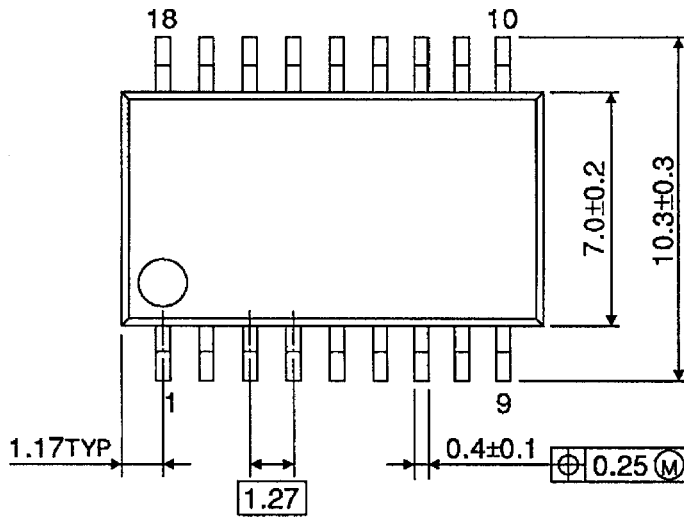

Weight: 0.41 g (Typ.)

RESTRICTIONS ON PRODUCT USE

000707EBA

- TOSHIBA is continually working to improve the quality and reliability of its products. Nevertheless, semiconductor devices in general can malfunction or fail due to their inherent electrical sensitivity and vulnerability to physical stress. It is the responsibility of the buyer, when utilizing TOSHIBA products, to comply with the standards of safety in making a safe design for the entire system, and to avoid situations in which a malfunction or failure of such TOSHIBA products could cause loss of human life, bodily injury or damage to property.
In developing your designs, please ensure that TOSHIBA products are used within specified operating ranges as set forth in the most recent TOSHIBA products specifications. Also, please keep in mind the precautions and conditions set forth in the "Handling Guide for Semiconductor Devices," or "TOSHIBA Semiconductor Reliability Handbook" etc..
- The TOSHIBA products listed in this document are intended for usage in general electronics applications (computer, personal equipment, office equipment, measuring equipment, industrial robotics, domestic appliances, etc.). These TOSHIBA products are neither intended nor warranted for usage in equipment that requires extraordinarily high quality and/or reliability or a malfunction or failure of which may cause loss of human life or bodily injury ("Unintended Usage"). Unintended Usage include atomic energy control instruments, airplane or spaceship instruments, transportation instruments, traffic signal instruments, combustion control instruments, medical instruments, all types of safety devices, etc.. Unintended Usage of TOSHIBA products listed in this document shall be made at the customer's own risk.
- The products described in this document are subject to the foreign exchange and foreign trade laws.
- The information contained herein is presented only as a guide for the applications of our products. No responsibility is assumed by TOSHIBA CORPORATION for any infringements of intellectual property or other rights of the third parties which may result from its use. No license is granted by implication or otherwise under any intellectual property or other rights of TOSHIBA CORPORATION or others.
- The information contained herein is subject to change without notice.

This datasheet has been download from:

www.datasheetcatalog.com

Datasheets for electronics components.