

SKT 55, SKT 80, SKT 100

V_{RSM}	V_{RRM} V_{DRM}	$(dv/dt)_{cr}$	I_{TRMS} (maximum values for continuous operation)		
			110 A	135 A	175 A
V	V	V/ μ s	I_{TAV} (sin. 180; $T_{case} = 80$ °C)		
			70 A	86 A	110 A
500	400	500	SKT 55/04 D	–	SKT 100/04 D
700	600	500	SKT 55/06 D	SKT 80/06 D*	–
900	800	500	SKT 55/08 D	SKT 80/08 D	SKT 100/08 D*
1300	1200	1000	SKT 55/12 E	SKT 80/12 E*	SKT 100/12 E*
1500	1400	1000	SKT 55/14 E	SKT 80/14 E	SKT 100/14 E*
1700	1600	1000	SKT 55/16 E	SKT 80/16 E	SKT 100/16 E*
1900	1800	1000	SKT 55/18 E♦	SKT 80/18 E♦	SKT 100/18 E♦

Thyristors

SKT 55 SKT 80 SKT 100



Symbol	Conditions	SKT 55	SKT 80	SKT 100	Units
I_{TAV}	sin. 180; ($T_{case} = \dots$)	55 (92)	80 (85)	100 (85)	A °C
I_{TSM}	$T_{vj} = 25$ °C; 10 ms $T_{vj} = 130$ °C; 10 ms	1 300 1 100	1 700 1 500	2 000 1 750	A A
i^2t	$T_{vj} = 25$ °C; 8,35 ... 10 ms $T_{vj} = 130$ °C; 8,35 ... 10 ms	8 500 6 000	14 500 11 000	20 000 15 000	A ² s A ² s
t_{gd}	$T_{vj} = 25$ °C $I_G = 1$ A $di_G/dt = 1$ A/ μ s	typ. 1			μ s
t_{gr}	$V_D = 0,67 \cdot V_{DRM}$	typ. 2			μ s
$(di/dt)_{cr}$	$f = 50 \dots 60$ Hz	50			A/ μ s
I_H	$T_{vj} = 25$ °C; typ./max.	150 / 250			mA
I_L	$T_{vj} = 25$ °C; typ./max.	300 / 600			mA
t_q	$T_{vj} = 130$ °C; typ.	100			μ s
V_T	$T_{vj} = 25$ °C; ($I_T = \dots$); max.	1,8 (200)	2,25 (300)	1,75 (300)	V A
$V_{T(TO)}$	$T_{vj} = 130$ °C	0,9	1,2	1,0	V
r_T	$T_{vj} = 130$ °C	4	4	2,4	m Ω
I_{DD} ; I_{RD}	$T_{vj} = 130$ °C; $V_{RD} = V_{RRM}$ $V_{DD} = V_{DRM}$	25	30	30	mA
V_{GT}	$T_{vj} = 25$ °C	3			V
I_{GT}	$T_{vj} = 25$ °C	150			mA
V_{GD}	$T_{vj} = 130$ °C	0,25			V
I_{GD}	$T_{vj} = 130$ °C	10			mA
R_{thjc}	cont. sin. 180 / rec. 120	0,40 0,47/0,53	0,25 0,28 / 0,31		°C/W °C/W
R_{thch}		0,08			°C/W
T_{vj}		– 40 ... + 130			°C
T_{stg}		– 40 ... + 150			°C
M	SI units US units	10 90			Nm lb. in.
a		5 · 9,81			m/s ²
w		65	80		g
Case		B 5			

* Available with UNF thread 1/2-20 UNF2A, e.g. SKT 80/06 D UNF

♦ Available in limited quantities

Features

- Hermetic metal cases with ceramic insulators
- Threaded studs ISO M12 or UNF 1/2-20
- Interchangeable with international standard cases

Typical Applications

- DC motor control (e. g. for machine tools)
- Controlled rectifiers (e. g. for battery charging)
- AC controllers (e. g. for temperature control)

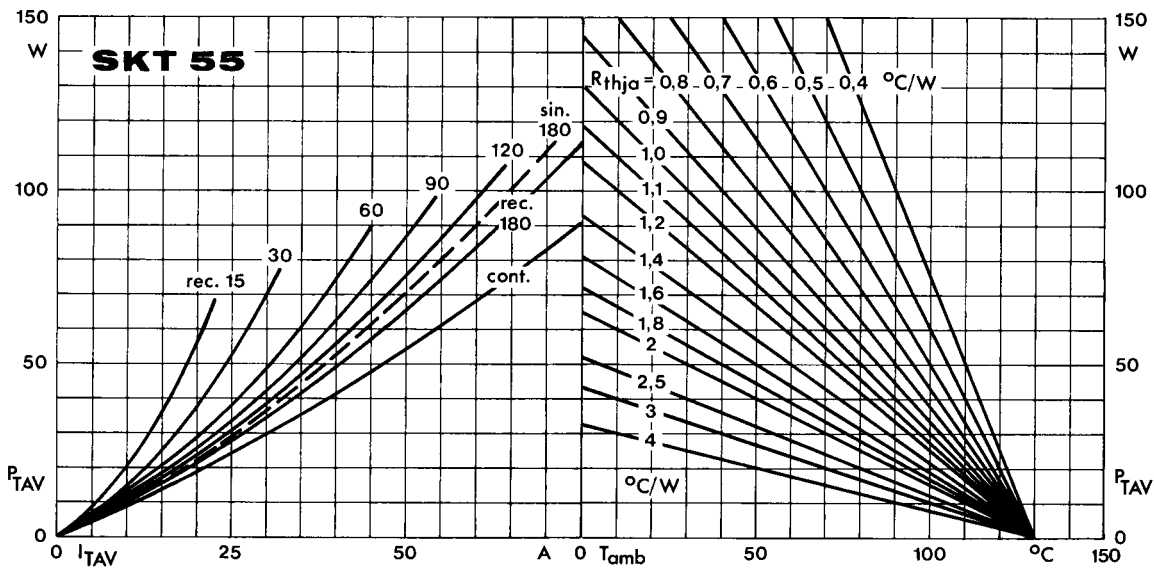

Fig. 1 a Power dissipation vs. on-state current and ambient temperature

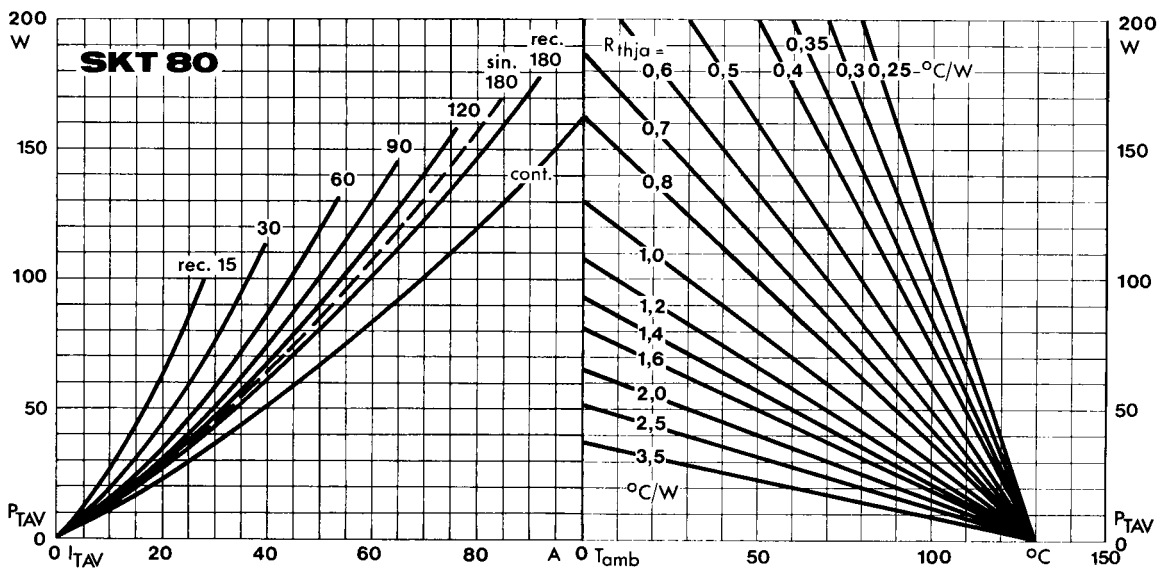

Fig. 1 b Power dissipation vs. on-state current and ambient temperature

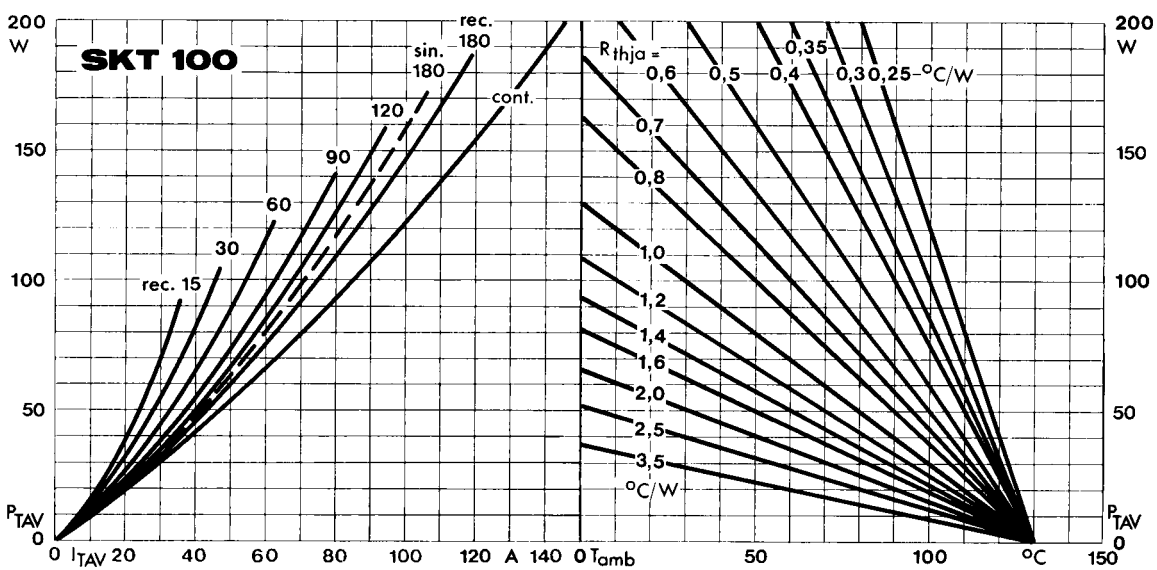

Fig. 1 c Power dissipation vs. on-state current and ambient temperature

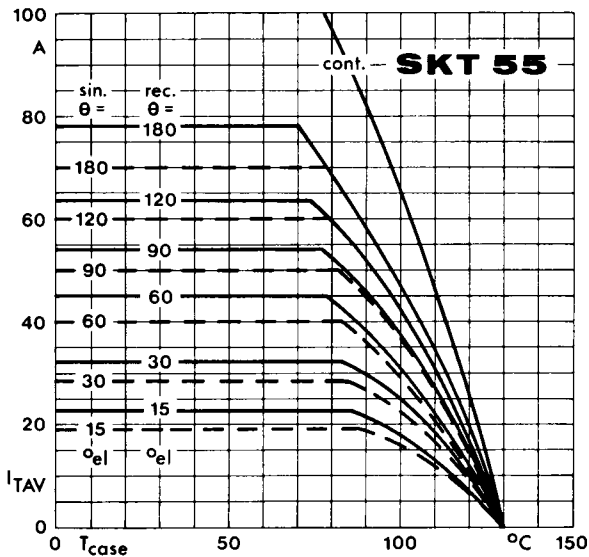

Fig. 2 a Rated on-state current vs. case temperature

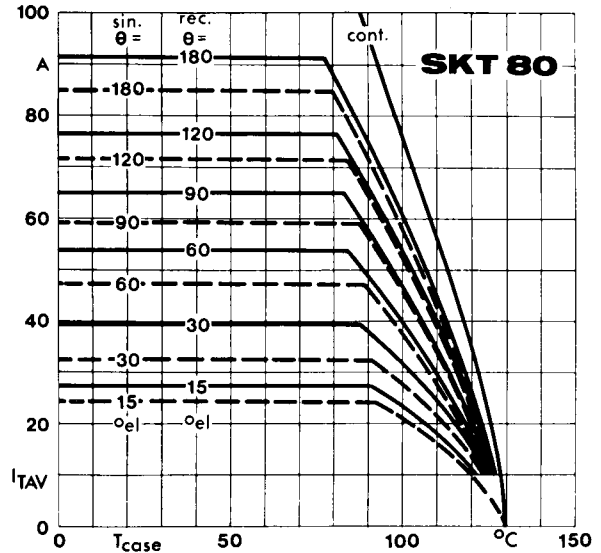

Fig. 2 b Rated on-state current vs. case temperature

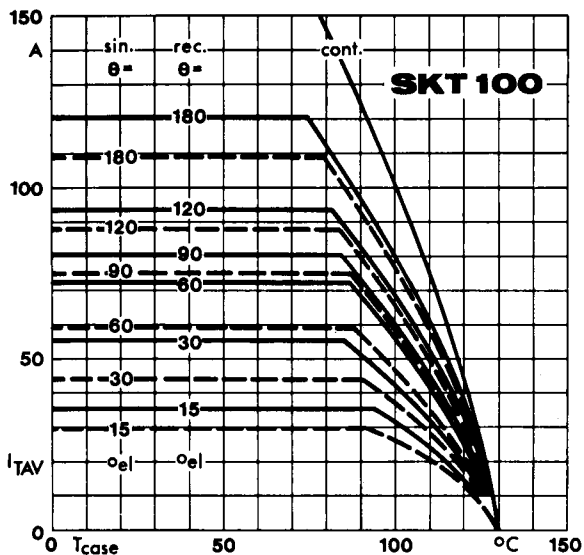

Fig. 2 c Rated on-state current vs. case temperature

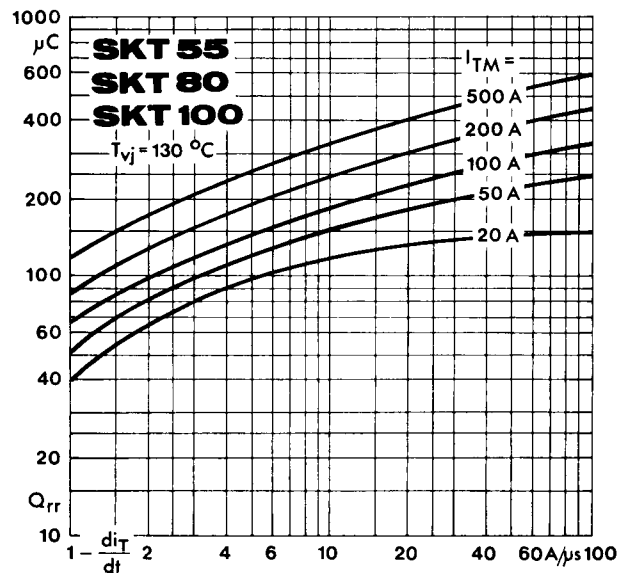

Fig. 3 Recovered charge vs. current decrease

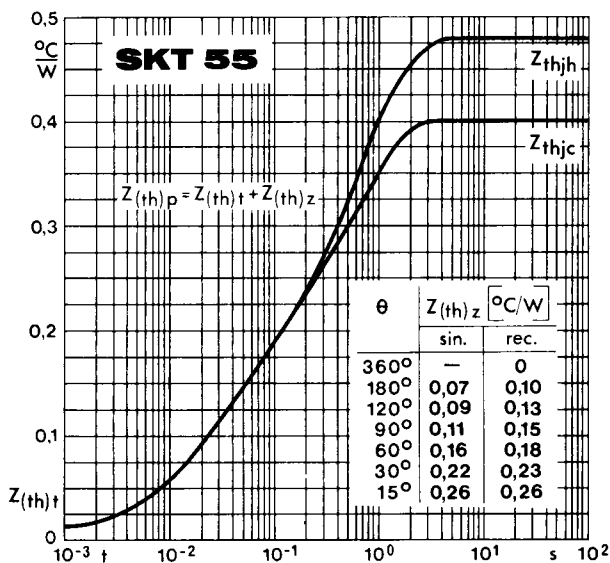

Fig. 4 a Transient thermal impedance vs. time

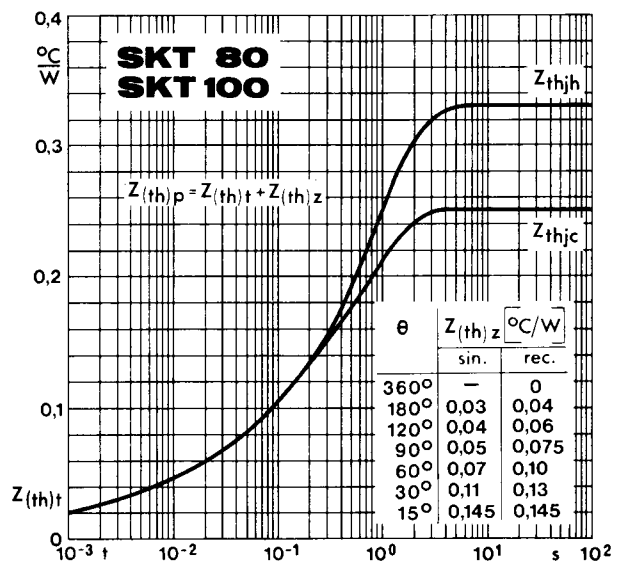

Fig. 4 b Transient thermal impedance vs. time

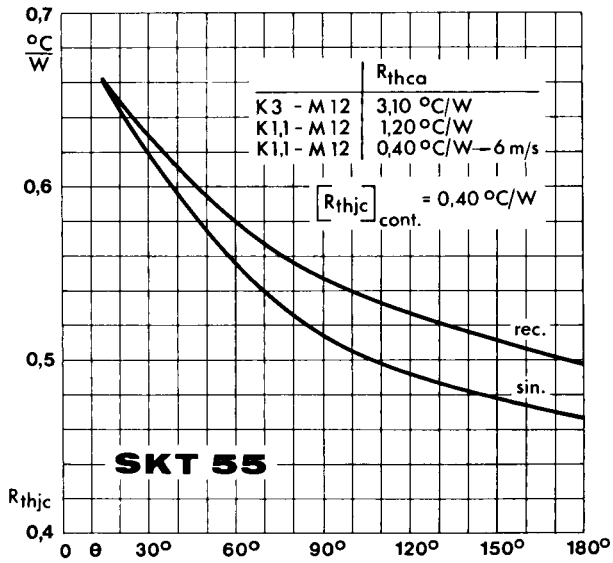

Fig. 5 a Thermal resistance vs. conduction angle

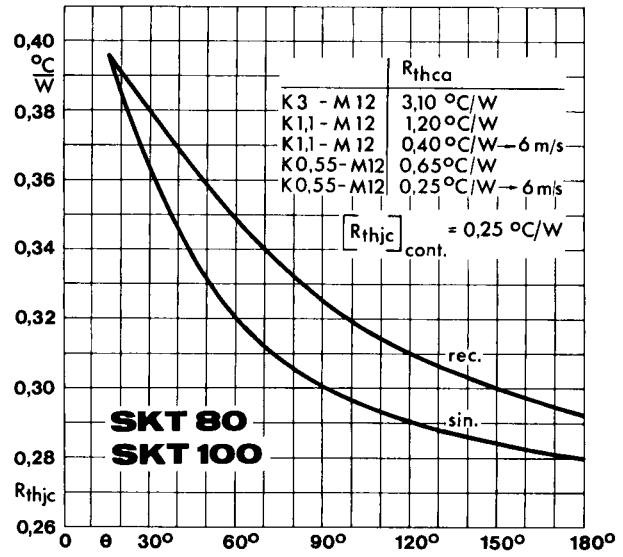

Fig. 5 b Thermal resistance vs. conduction angle

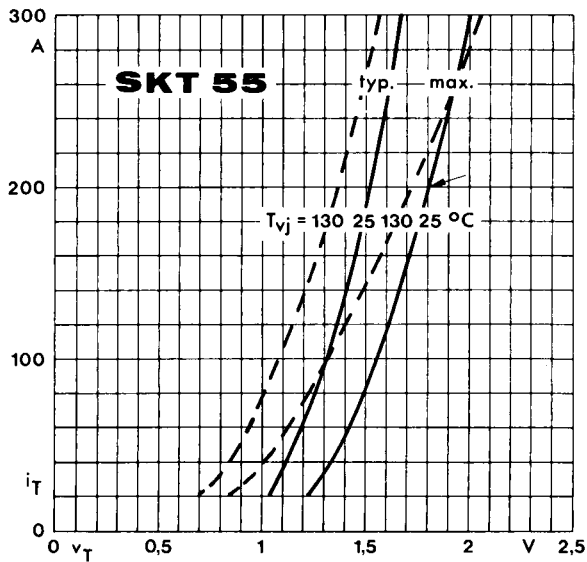

Fig. 6 a On-state characteristics

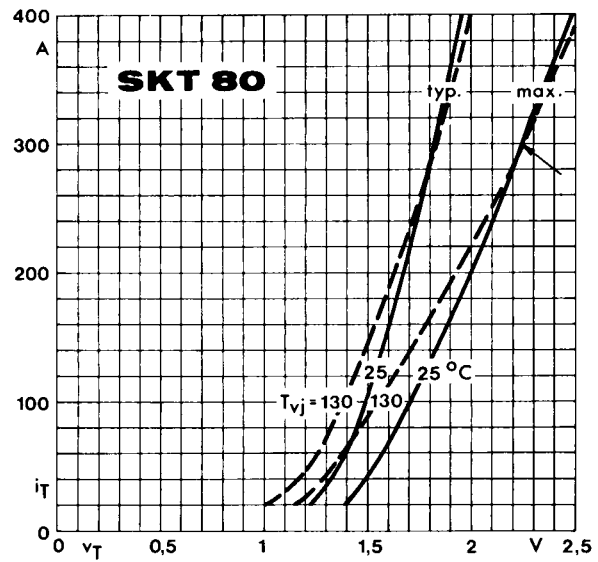

Fig. 6 b On-state characteristics

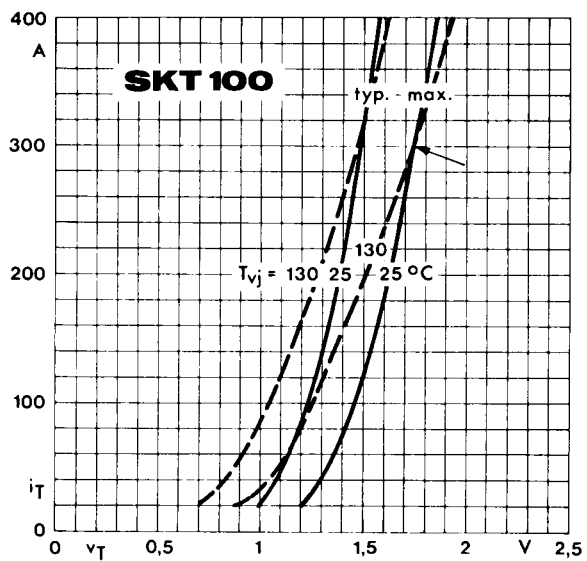

Fig. 6 c On-state characteristics

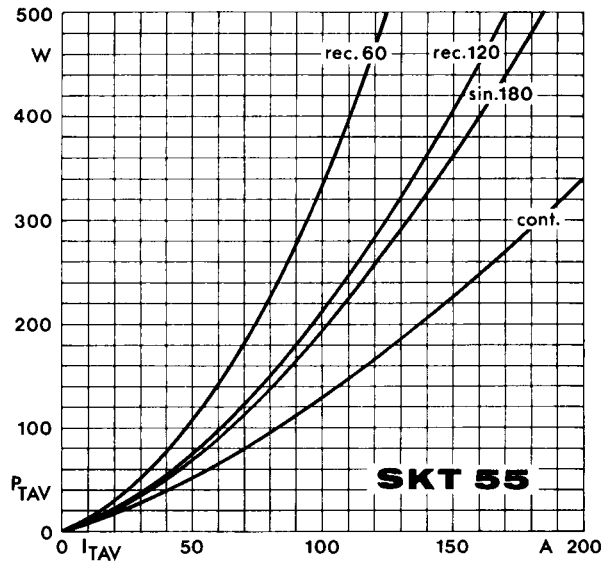

Fig. 7 a Power dissipation vs. on-state current

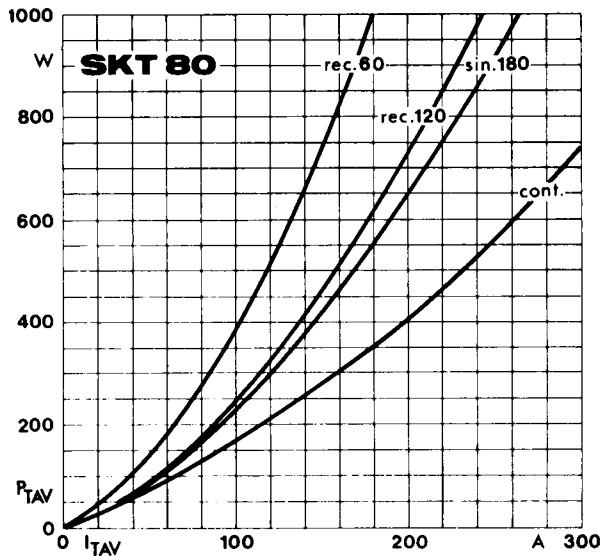

Fig. 7 b Power dissipation vs. on-state current

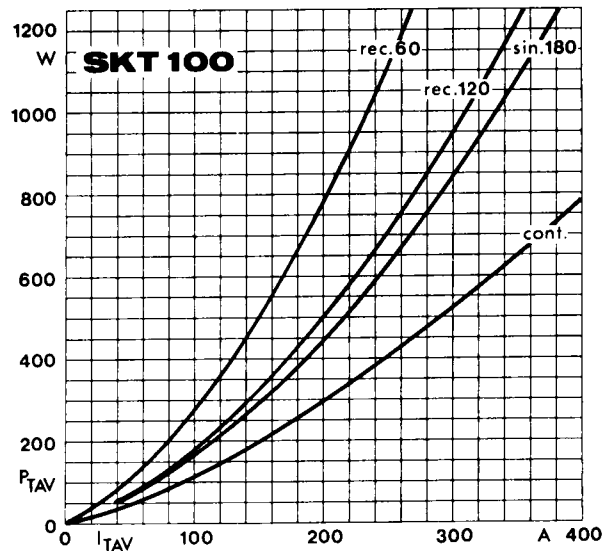

Fig. 7 c Power dissipation vs. on-state current

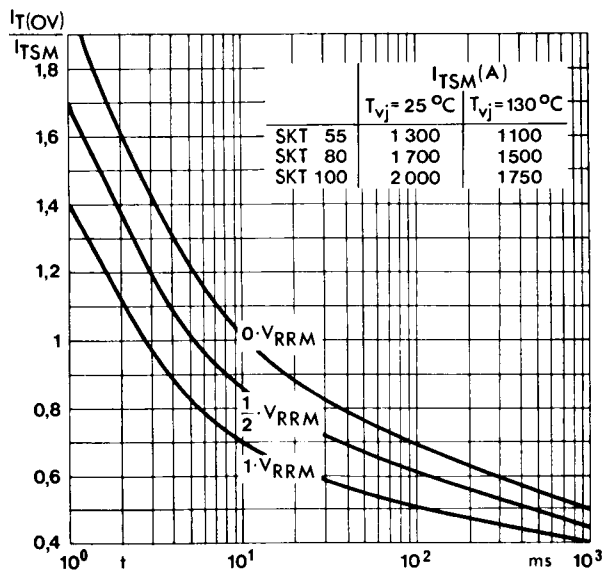

Fig. 8 Surge overload current vs. time

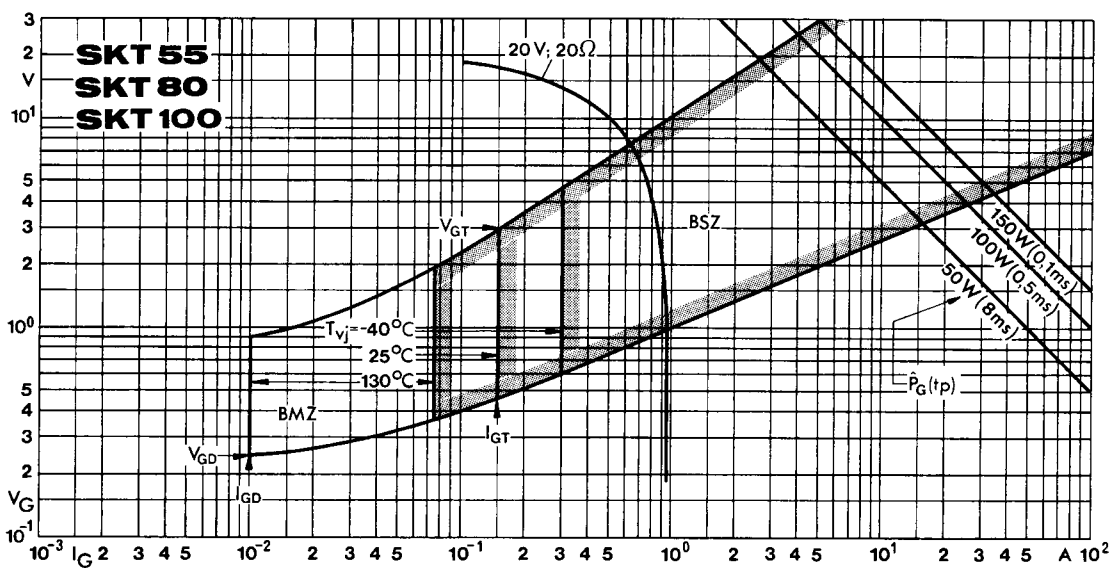

Fig. 9 Gate trigger characteristics

**SKT 55
SKT 80
SKT 100**

Case B 5

IEC-Publ. 191-2: (A 12 MA, A 12 U)

DIN 41892: (204 B 3)

BS 3934: SO - 30 C

JEDEC: TO - 209 (TO - 94)¹⁾

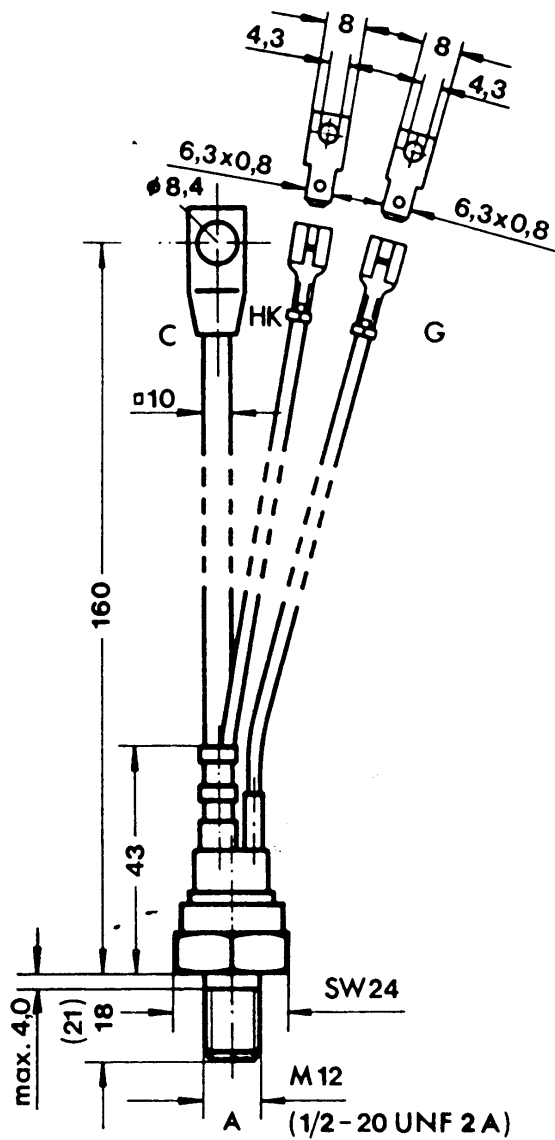

¹⁾ modified version. In the USA and Canada these types are available with the original TO-209 (TO-94) dimensions. TO-208 AD (TO-83) with flag terminals is also available.

**SKT 130
SKT 160**

Case B 6

IEC-Publ. 191-2: A 47 MC

DIN 41893: 205 B 4

JEDEC: TO-209 (TO-93)

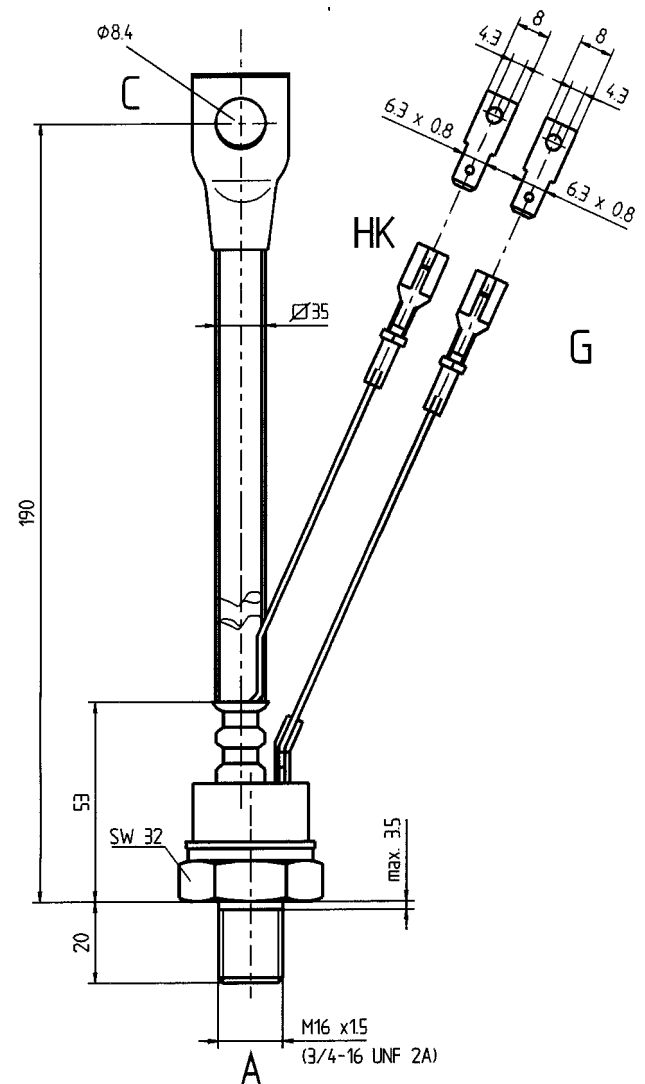

Dimensions in mm

- C: Cathode terminal (red sleeve)
- A: Anode terminal
- G: Gate terminal (yellow sleeve)
- HK: Auxiliary cathode terminal (red sleeve)