

## Thyristors

**SKT 40**  
**SKT 50**



V <sub>RSM</sub>	V <sub>RRM</sub> V <sub>DRM</sub>	$\left(\frac{dv}{dt}\right)_{cr}$	I <sub>T</sub> RMS (maximum values for continuous operation)	
			63 A	78 A
V	V	V/μs	I <sub>TAV</sub> (sin. 180; T <sub>case</sub> = . . . °C)	
			40 A (80 °C)	50 A (78 °C)
500	400	500	<b>SKT 40/04 D</b>	–
700	600	500	<b>SKT 40/06 D</b>	<b>SKT 50/06 D*</b>
900	800	500	<b>SKT 40/08 D</b>	<b>SKT 50/08 D</b>
1300	1200	1000	<b>SKT 40/12 E</b>	<b>SKT 50/12 E*</b>
1500	1400	1000	<b>SKT 40/14 E</b>	<b>SKT 50/14 E*</b>
1700	1600	1000	<b>SKT 40/16 E</b>	<b>SKT 50/16 E*</b>
1900	1800	1000	<b>SKT 40/18 E+</b>	<b>SKT 50/18 E+</b>

Symbol	Conditions	SKT 40	SKT 50	Units
I <sub>TAV</sub>	sin. 180; T <sub>case</sub> = 85 °C	38	45	A
I <sub>TSM</sub>	T <sub>vj</sub> = 25 °C; 10 ms T <sub>vj</sub> = 130 °C; 10 ms	700 600	1050 900	A A
i <sup>2</sup> t	T <sub>vj</sub> = 25 °C; 8,35 ... 10 ms T <sub>vj</sub> = 130 °C; 8,35 ... 10 ms	2500 1800	5000 4000	A <sup>2</sup> s A <sup>2</sup> s
t <sub>gd</sub>	T <sub>vj</sub> = 25 °C; I <sub>G</sub> = 1 A; di <sub>G</sub> /dt = 1 A/μs	typ. 1		μs
t <sub>gr</sub>	V <sub>D</sub> = 0,67 · V <sub>DRM</sub>	typ. 1,5		μs
(di/dt) <sub>cr</sub>	f = 50 ... 60 Hz	50		A/μs
I <sub>H</sub>	T <sub>vj</sub> = 25 °C	typ. 100; max. 200		mA
I <sub>L</sub>	T <sub>vj</sub> = 25 °C; R <sub>G</sub> = 33 Ω	typ. 250; max. 400		mA
t <sub>q</sub>	T <sub>vj</sub> = 130 °C; typ.	100		μs
V <sub>T</sub>	T <sub>vj</sub> = 25 °C; I <sub>T</sub> = 120 A; max.	1,95	1,8	V
V <sub>T(TO)</sub>	T <sub>vj</sub> = 130 °C	1,0	1,1	V
r <sub>T</sub>	T <sub>vj</sub> = 130 °C	9	5	mΩ
I <sub>DD</sub> , I <sub>RD</sub>	T <sub>vj</sub> = 130 °C; V <sub>DD</sub> = V <sub>DRM</sub> V <sub>RD</sub> = V <sub>RRM</sub>	8	8	mA
V <sub>GT</sub>	T <sub>vj</sub> = 25 °C	3		V
I <sub>GT</sub>	T <sub>vj</sub> = 25 °C	150		mA
V <sub>GD</sub>	T <sub>vj</sub> = 130 °C	0,25		V
I <sub>GD</sub>	T <sub>vj</sub> = 130 °C	5		mA
R <sub>thjc</sub>	cont. sin. 180 rec. 120	0,60 0,66 0,70	0,57 0,60 0,65	°C/W °C/W °C/W
R <sub>thch</sub>		0,20		°C/W
T <sub>vj</sub>		– 40 ... +130		°C
T <sub>stg</sub>		– 55 ... +150		°C
M	SI units US units	4 (UNF: 2,5) 35 (UNF: 22)		Nm lb. in.
a		5 · 9,81		m/s <sup>2</sup>
w		2,2		g
Case		B 3		

### Features

- Hermetic metal cases with glass insulators
- Threaded studs ISO M8 or UNF 1/4-28
- International standard cases

### Typical Applications

- DC motor control (e. g. for machine tools)
- Controlled rectifiers (e. g. for battery charging)
- AC controllers (e. g. for temperature control)

\* Available with UNF thread 1/4-28 UNF2A, e.g. SKT 50/06 D UNF

♦ available in limited quantities

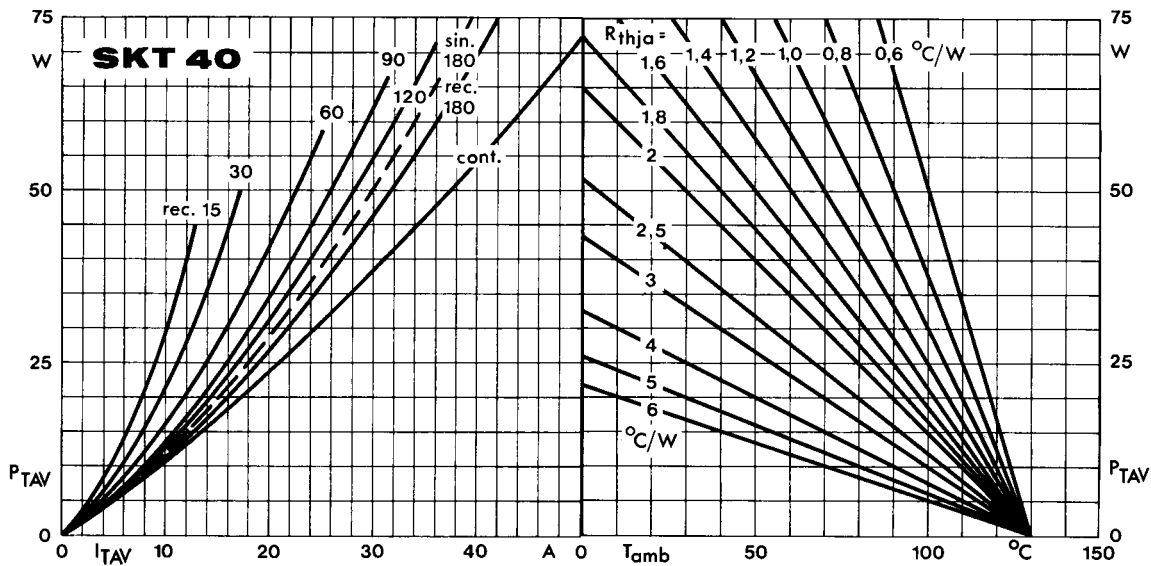

Fig. 1 a Power dissipation vs. on-state current and ambient temperature

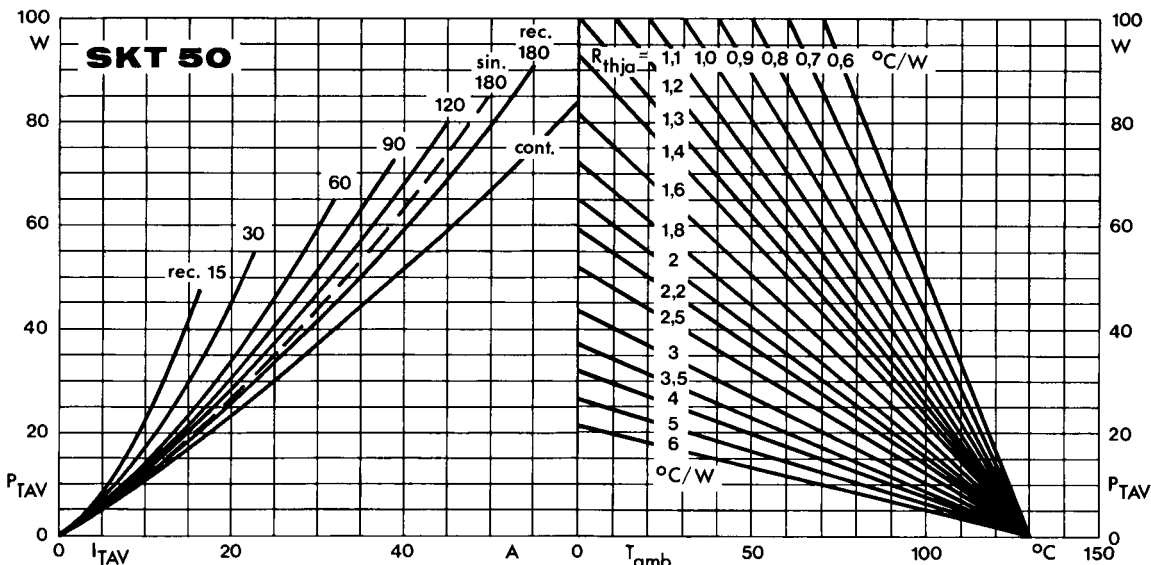

Fig. 1 b Power dissipation vs. on-state current and ambient temperature

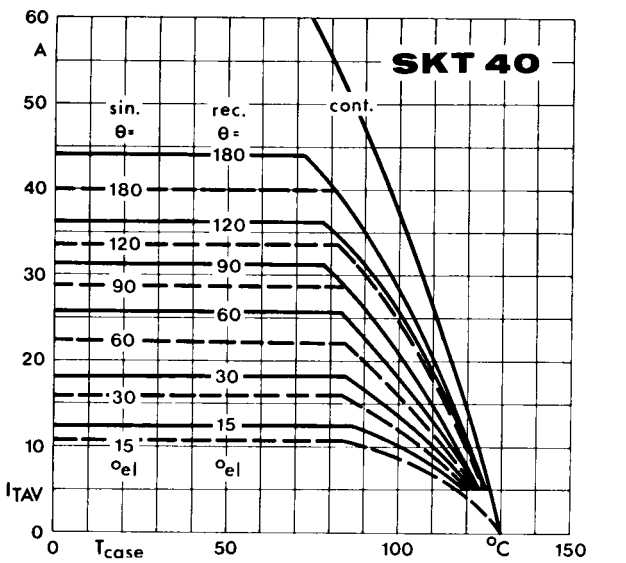

Fig. 2 a Rated on-state current vs. case temperature

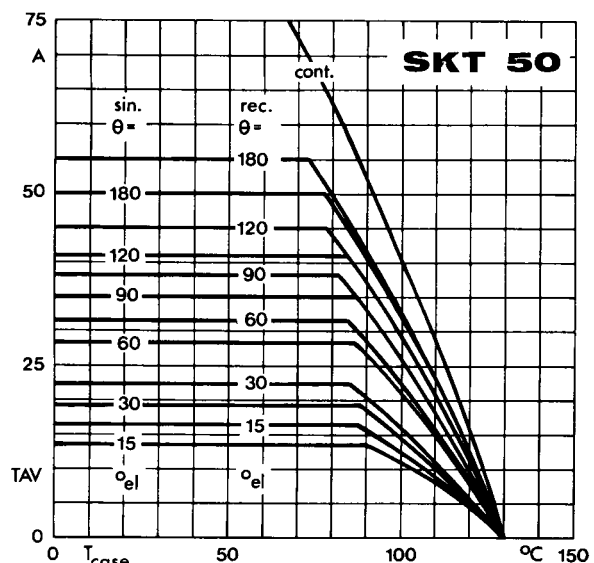

Fig. 2 b Rated on-state current vs. case temperature

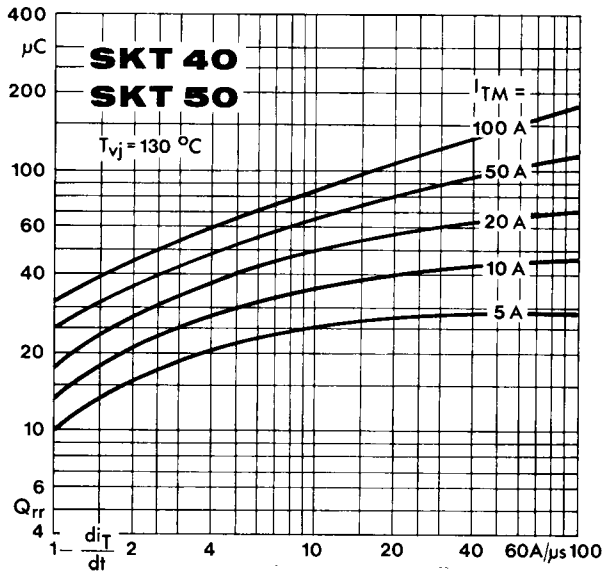

Fig. 3 Recovered charge vs. current decrease

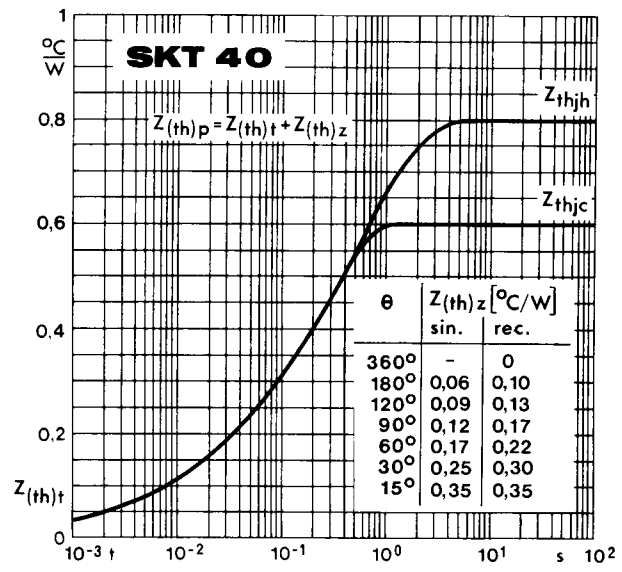

Fig. 4 a Transient thermal impedance vs. time

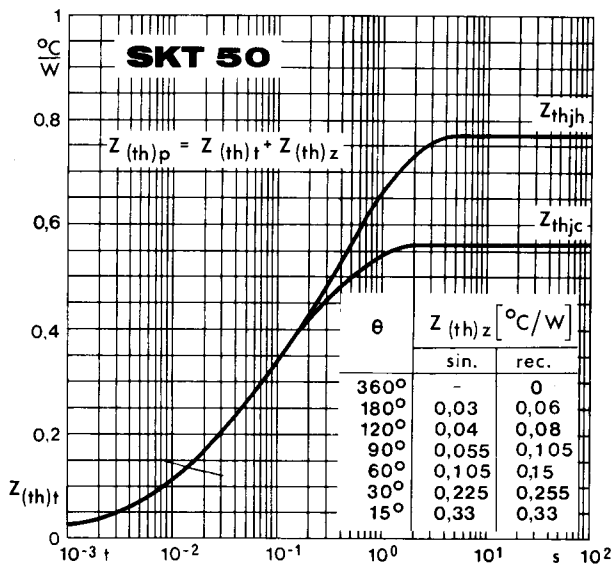

Fig. 4 b Transient thermal impedance vs. time

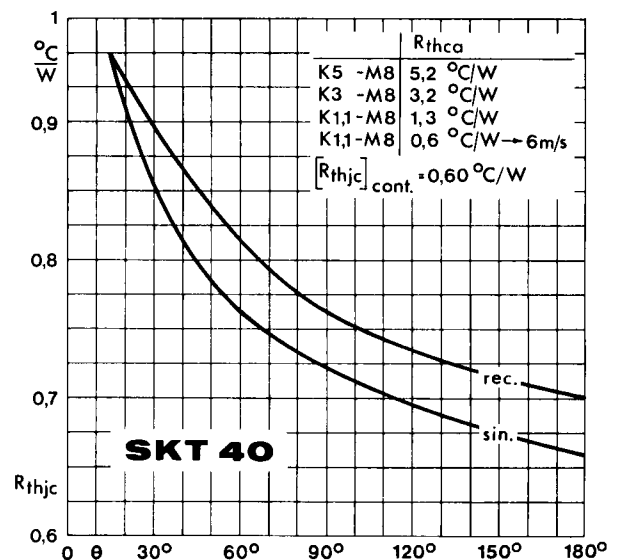

Fig. 5 a Thermal resistance vs. conduction angle

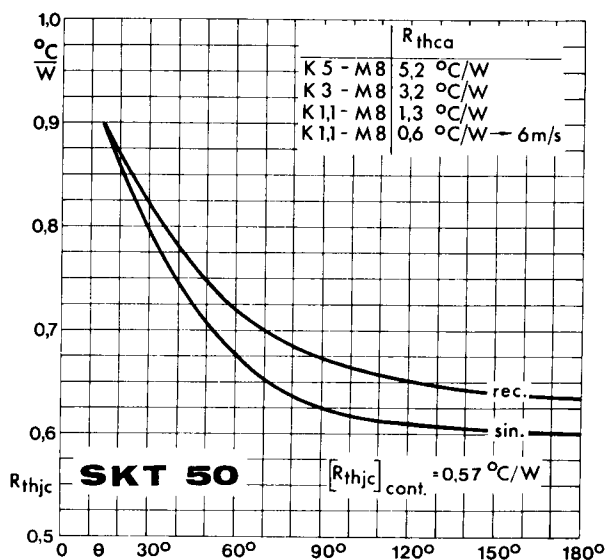

Fig. 5 b Thermal resistance vs. conduction angle

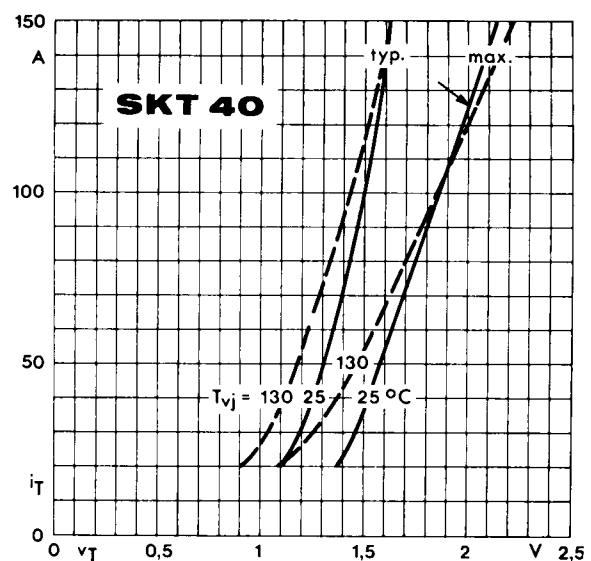

Fig. 6 a On-state characteristics

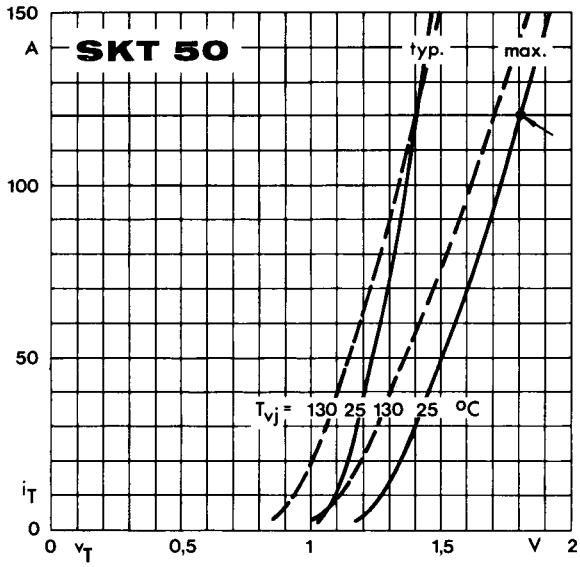

Fig. 6 b On-state characteristics

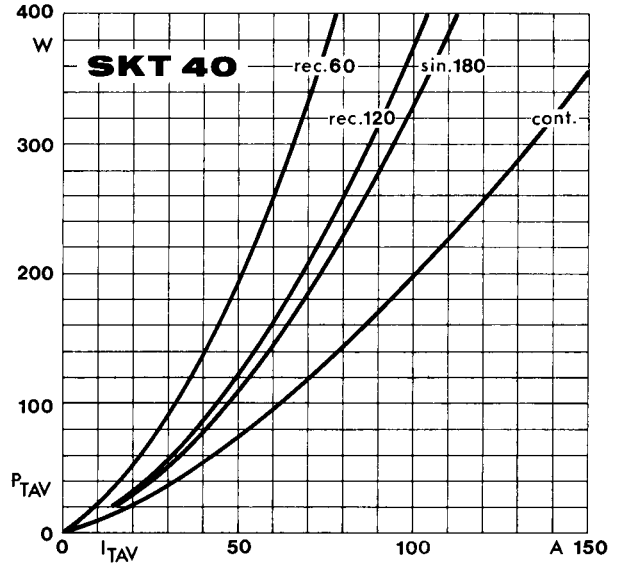

Fig. 7 a Power dissipation vs. on-state current

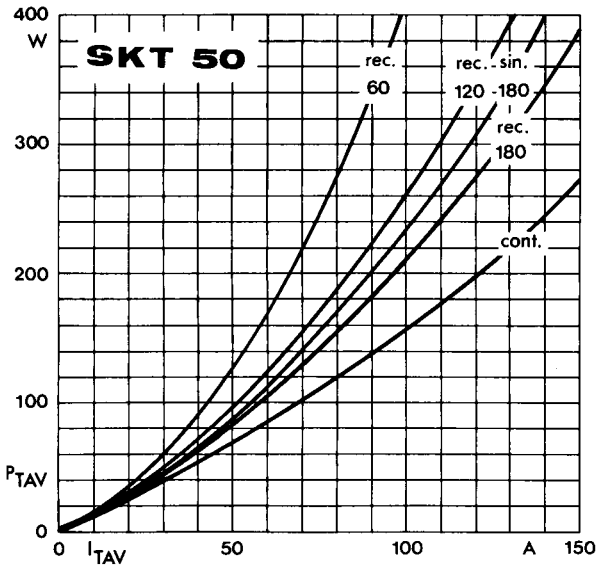

Fig. 7 b Power dissipation vs. on-state current

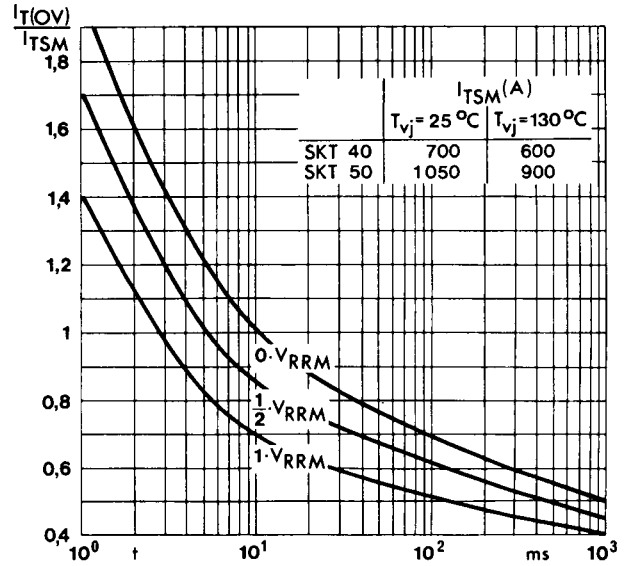

Fig. 8 Surge overload current vs. time

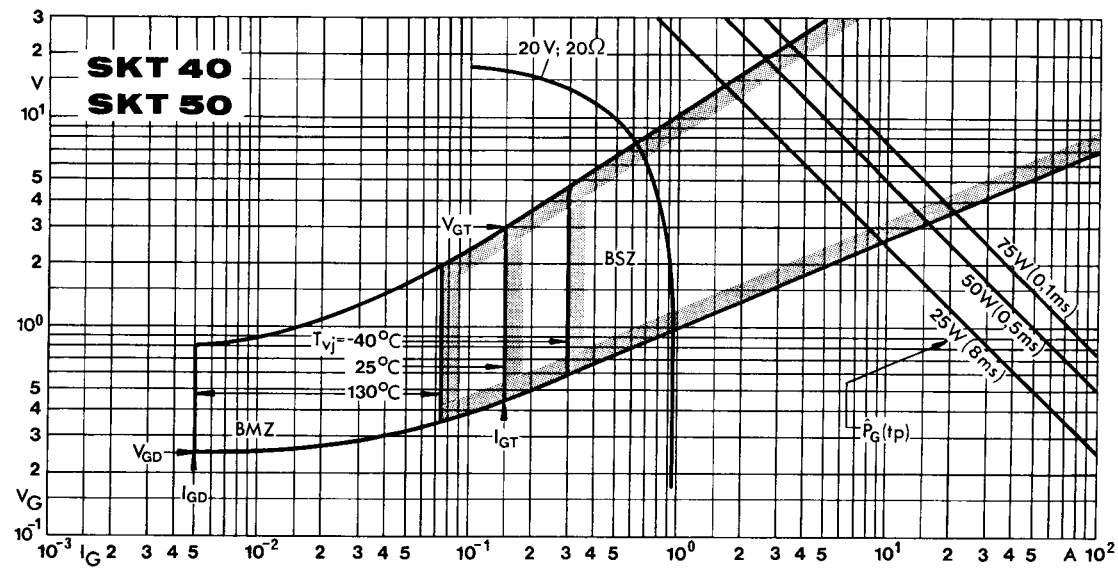

Fig. 9 Gate trigger characteristics

**SKT 10**

Case B 1

IEC-Publ. 191-2: A 13 M

DIN 41891: 200 B 3

BS 3934: SO-35 A

JEDEC: TO-208 AB (TO-64) metric

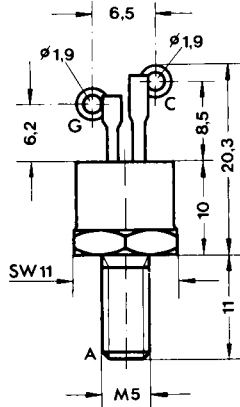
**SKT 16  
SKT 24**

Case B 2

IEC-Publ. 191-2: A 11 M, A 11 U

DIN 41892: 201 C 3

BS 3934: SO-36

JEDEC: TO-208 AA (TO-48)

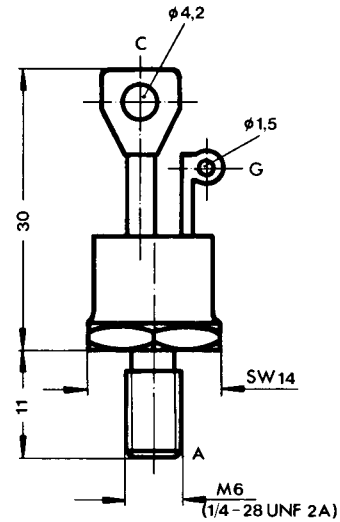
**SKT 40  
SKT 50**

Case B 3

IEC-Publ. 191-2: A 38 MA, A 14 U

DIN 41892: 202 C 3

BS 3934: SO-28

JEDEC: TO-208 AC (TO-65)

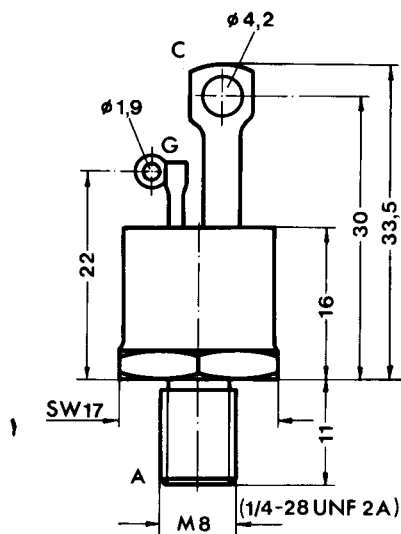

C: Cathode terminal  
 A: Anode terminal  
 G: Gate terminal

Dimensions in mm