



Rectifier Diodes

SKN 320 SKR 320
SKN 400

V _{RRM} V _{RRM}	I _{FRMS} (maximum values for continuous operation) 700 A		
	I _{FAV} (sin. 180; T _{case} = 100 °C)		
	420 A		400 A
V			
200	SKN 320/02	SKR 320/02	–
400	SKN 320/04	SKR 320/04	–
800	SKN 320/08	SKR 320/08	–
1200	SKN 320/12	SKR 320/12	–
1400	SKN 320/14	SKR 320/14	–
1600	SKN 320/16	SKR 320/16	–
1800	–	–	SKN 400/18
2400	–	–	SKN 400/24
2700	–	–	SKN 400/27
3000	–	–	SKN 400/30

Symbol	Conditions	SKN 320 SKR 320	SKN 400
I _{FAV}	sin. 180; T _{case} = 87 °C = 100 °C = 125 °C	– 420 A 320 A	450 A 400 A –
I _{FSM}	T _{vj} = 25 °C; 10 ms T _{vj max.} ; 10 ms	9 000 A 8 000 A	9 000 A 7 500 A
i ² t	T _{vj} = 25 °C; 8,3 ... 10 ms T _{vj max.} ; 8,3 ... 10 ms	400 000 A ² s 300 000 A ² s	400 000 A ² s 280 000 A ² s
Q _{rr}	T _{vj} = 160 °C; – $\frac{di_F}{dt} = 10 \frac{A}{\mu s}$	typ. 300 μC	typ. 400 μC
I _R	T _{vj} = 25 °C; V _R = V _{RRM} T _{vj max.} ; V _R = V _{RRM}	3 mA 100 mA	3 mA 60 mA
V _F	T _{vj} = 25 °C; (I _F = ...); max.	1,35 V (1000 A)	1,45 V (1200 A)
V _(TO)	T _{vj max.}	0,8 V	0,9 V
r _T	T _{vj max.}	0,45 mΩ	0,5 mΩ
R _{thjc}		0,16 °C/W	0,11 °C/W
R _{thch}		0,015 °C/W	0,01 °C/W
T _{vj}		– 40 ... + 180 °C	– 40 ... + 160 °C
T _{stg}		– 55 ... + 180 °C	– 55 ... + 160 °C
M a w	SI units/US units approx.	60 Nm/530 lb. in. 5 · 9,81 m/s ² 500 g	
R _C R _p	P _R = 2 W P _R = 20 W	1 μF + 20 Ω 25 kΩ	
Case		E 16	E 17

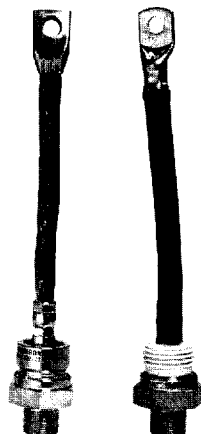

Features

- Reverse voltages up to 3000 V
- Hermetic metal cases with glass insulators; SKN 400 ceramic insulator with extra long creepage distances
- Threaded studs ISO M24 x 1,5
- **SKN**: anode to stud
SKR: cathode to stud

Typical Applications

- SKN/SKR 320: all-purpose high power rectifier diodes
- SKN 400: high voltage rectifier diode, especially for traction applications
- Cooling via heatsinks
- Non-controllable and half-controllable rectifiers, free-wheeling diodes

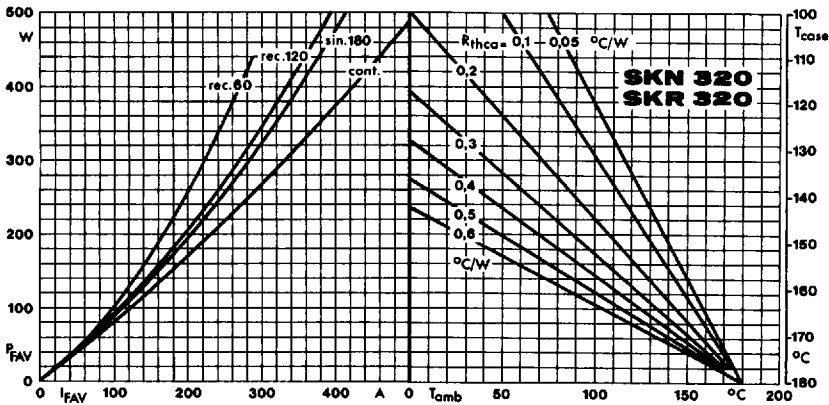

Fig. 1 a Power dissipation vs. forward current and case temperature

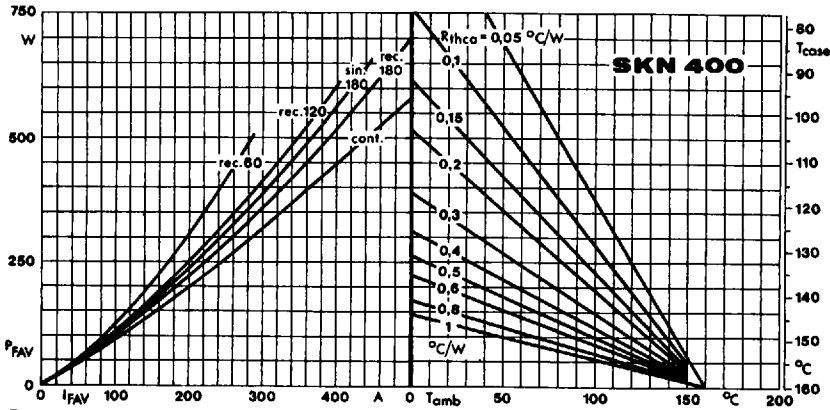

Fig. 1 b Power dissipation vs. forward current and case temperature

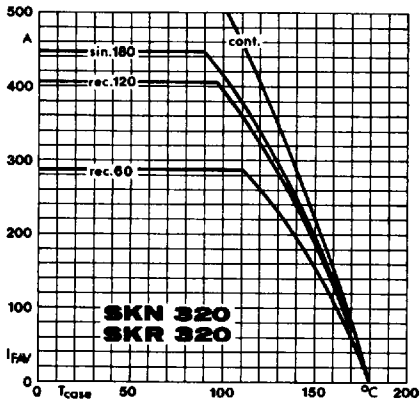

Fig. 3 a Rated forward current vs. case temperature

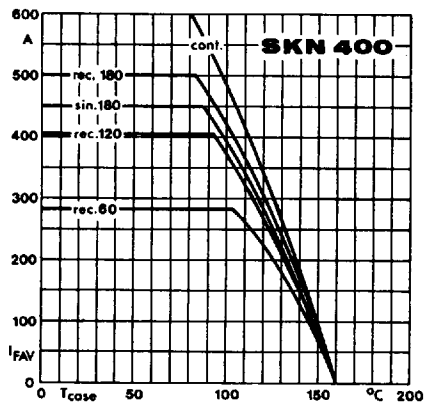

Fig. 3 b Rated forward current vs. case temperature

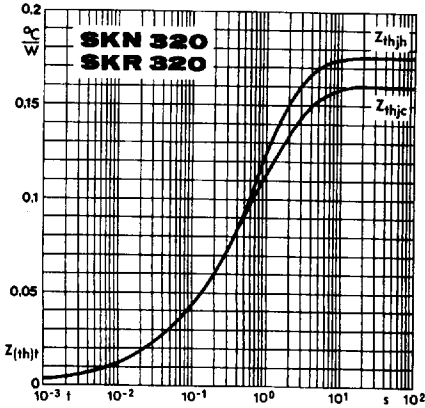

Fig. 5 a Transient thermal impedance vs. time

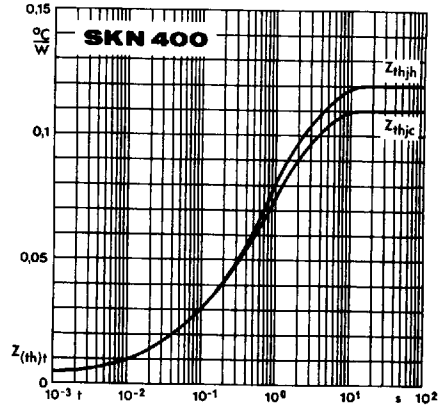

Fig. 5 b Transient thermal impedance vs. time

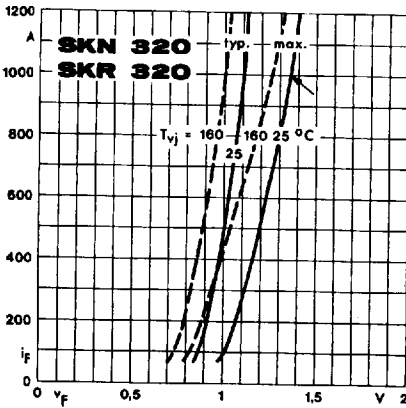

Fig. 6 a Forward characteristics

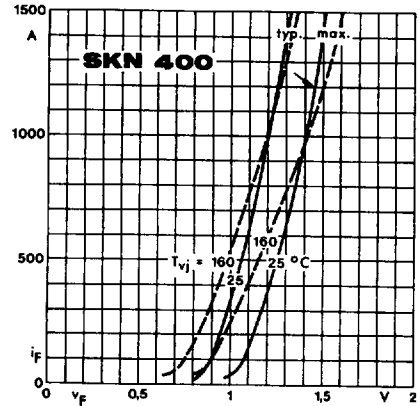

Fig. 6 b Forward characteristics

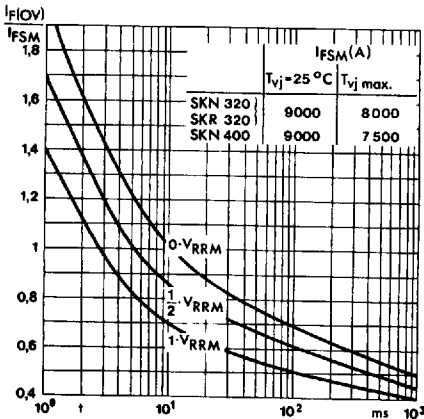

Fig. 7 Surge overload current vs. time

SKN 320
SKR 320

Case E 16

IEC: A 22 B

DIN 41 888: 107 B

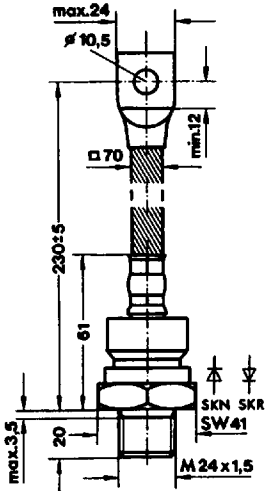

SKN 400

Case E 17

IEC: A 22 B

DIN 41 888: 107 B 2

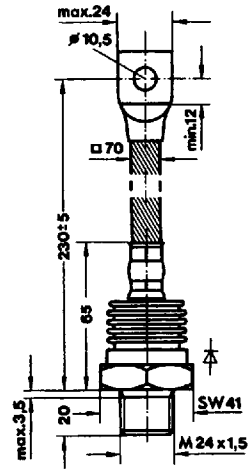

SKN 450
SKN 501

Case E 18

DIN 41 814: 151 A 2

JEDEC: DO-200 AA

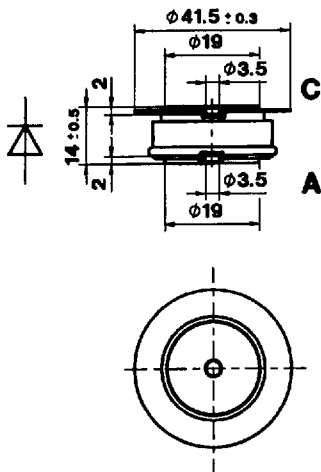

SKN 870

Case E 19

DIN 41 814: 153 C 2

JEDEC: DO-200 AB

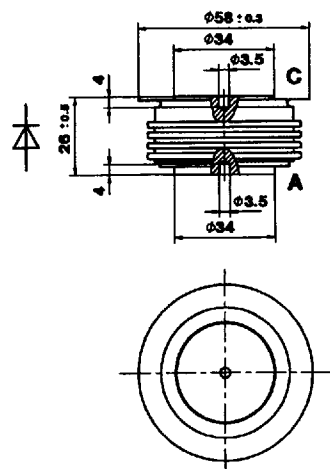

Dimensions in mm