

SKM 300GB063D

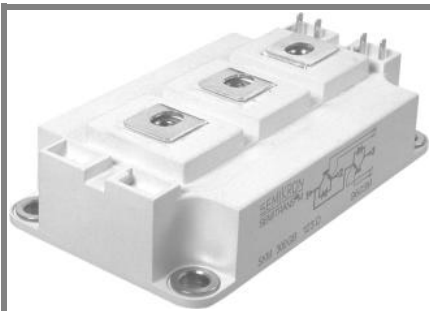

SEMITRANS® 3

Superfast IGBT Modules

SKM 300GB063D

SKM 300GAR063D

SKM 300GAL063D

Features

- NPT- Non punch-through IGBT
- Low tail current with low temperature dependence
- High short circuit capability, self limiting if term. G is clamped to E
- Pos. temp.-coeff. of V_{CEsat}
- 50 % less turn off losses
- 30 % less short circuit current
- Very low C_{ies} , C_{oes} , C_{res}
- Latch-up free
- Fast & soft inverse CAL diodes
- Isolated copper baseplate using DCB Direct Copper Bonding Technology without hard mould
- Large clearance (13 mm) and creepage distances (20 mm)

Typical Applications*

- Switching (not for linear use)
- Switched mode power supplies
- AC inverter servo drives
- UPS uninterruptable power supplies
- Welding inverters

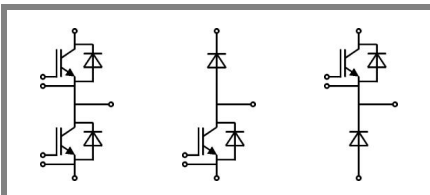

GB

GAL

GAR

Absolute Maximum Ratings		$T_c = 25\text{ }^\circ\text{C}$, unless otherwise specified		
Symbol	Conditions	Values		Units
IGBT				
V_{CES}	$T_j = 25\text{ }^\circ\text{C}$	600		V
I_C	$T_j = 150\text{ }^\circ\text{C}$	$T_{case} = 25\text{ }^\circ\text{C}$	400	A
		$T_{case} = 70\text{ }^\circ\text{C}$	300	A
I_{CRM}	$I_{CRM} = 2 \times I_{Cnom}$	600		A
V_{GES}		± 20		V
t_{psc}	$V_{CC} = 300\text{ V}$; $V_{GE} \leq 20\text{ V}$; $T_j = 125\text{ }^\circ\text{C}$ $V_{CES} < 600\text{ V}$	10		μs
Inverse Diode				
I_F	$T_j = 150\text{ }^\circ\text{C}$	$T_{case} = 25\text{ }^\circ\text{C}$	250	A
		$T_{case} = 80\text{ }^\circ\text{C}$	170	A
I_{FRM}	$I_{FRM} = 2 \times I_{Fnom}$	600		A
I_{FSM}	$t_p = 10\text{ ms}$; sin.	$T_j = 150\text{ }^\circ\text{C}$	1600	A
Freewheeling Diode				
I_F	$T_j = 150\text{ }^\circ\text{C}$	$T_c = 25\text{ }^\circ\text{C}$	400	A
		$T_c = 80\text{ }^\circ\text{C}$	270	A
I_{FRM}	$I_{FRM} = 2 \times I_{Fnom}$	800		A
I_{FSM}	$t_p = 10\text{ ms}$; sin.	$T_j = 150\text{ }^\circ\text{C}$	2800	A
Module				
$I_{t(RMS)}$		500		A
T_{vj}		- 40 ... + 150		$^\circ\text{C}$
T_{stg}		- 40 ... + 125		$^\circ\text{C}$
V_{isol}	AC, 1 min.	2500		V

Characteristics		$T_c = 25\text{ }^\circ\text{C}$, unless otherwise specified			
Symbol	Conditions	min.	typ.	max.	Units
IGBT					
$V_{GE(th)}$	$V_{GE} = V_{CE}$, $I_C = 6\text{ mA}$	4,5	5,5	6,5	V
I_{CES}	$V_{GE} = 0\text{ V}$, $V_{CE} = V_{CES}$		0,2	0,6	mA
V_{CE0}		$T_j = 25\text{ }^\circ\text{C}$	1,05		V
		$T_j = 125\text{ }^\circ\text{C}$	1		V
r_{CE}	$V_{GE} = 15\text{ V}$	$T_j = 25\text{ }^\circ\text{C}$	3,2		$\text{m}\Omega$
		$T_j = 125\text{ }^\circ\text{C}$	4,7		$\text{m}\Omega$
$V_{CE(sat)}$	$I_{Cnom} = 300\text{ A}$, $V_{GE} = 15\text{ V}$	$T_j = 25\text{ }^\circ\text{C}_{chiplev.}$	2,1	2,5	V
		$T_j = 125\text{ }^\circ\text{C}_{chiplev.}$	2,4	2,8	V
C_{ies}	$V_{CE} = 25$, $V_{GE} = 0\text{ V}$	$f = 1\text{ MHz}$	17		nF
C_{oes}			2		nF
C_{res}			1,2		nF
Q_G	$V_{GE} = 0\text{ V} \dots 15\text{ V}$	720		nC	
R_{Gint}	$T_j = \text{ }^\circ\text{C}$	0		Ω	
$t_{d(on)}$	$R_{Gon} = 6\text{ }\Omega$	$V_{CC} = 300\text{ V}$ $I_C = 300\text{ A}$	160		ns
t_r			80		ns
E_{on}	$R_{Goff} = 6\text{ }\Omega$	$T_j = 125\text{ }^\circ\text{C}$ $V_{GE} = \pm 15\text{ V}$	14		mJ
$t_{d(off)}$			550		ns
t_f			50		ns
E_{off}			13		mJ
$R_{th(j-c)}$	per IGBT			0,09	K/W

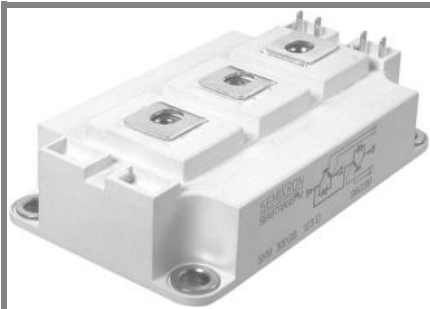

SEMITRANS® 3

Superfast IGBT Modules

SKM 300GB063D

SKM 300GAR063D

SKM 300GAL063D

Features

- NPT- Non punch-through IGBT
- Low tail current with low temperature dependence
- High short circuit capability, self limiting if term. G is clamped to E
- Pos. temp.-coeff. of V_{CEsat}
- 50 % less turn off losses
- 30 % less short circuit current
- Very low C_{ies} , C_{oes} , C_{res}
- Latch-up free
- Fast & soft inverse CAL diodes
- Isolated copper baseplate using DCB Direct Copper Bonding Technology without hard mould
- Large clearance (13 mm) and creepage distances (20 mm)

Typical Applications*

- Switching (not for linear use)
- Switched mode power supplies
- AC inverter servo drives
- UPS uninterruptable power supplies
- Welding inverters

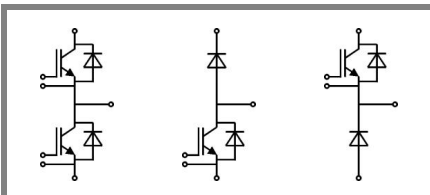

GB

GAL

GAR

Characteristics					
Symbol	Conditions	min.	typ.	max.	Units
Inverse Diode					
$V_F = V_{EC}$	$I_{Fnom} = 300 \text{ A}; V_{GE} = 0 \text{ V}$	$T_j = 25 \text{ }^\circ\text{C}_{chiplev.}$	1,65	2	V
		$T_j = 125 \text{ }^\circ\text{C}_{chiplev.}$	1,65	2	V
V_{F0}		$T_j = 125 \text{ }^\circ\text{C}$		0,9	V
r_F		$T_j = 125 \text{ }^\circ\text{C}$	3	3,7	mΩ
I_{RRM}	$I_F = 300 \text{ A}$	$T_j = 125 \text{ }^\circ\text{C}$	120		A
Q_{rr}			18		μC
E_{rr}	$V_{GE} = -15 \text{ V}; V_{CC} = 300 \text{ V}$				mJ
$R_{th(j-c)D}$	per diode			0,25	K/W
Freewheeling Diode					
$V_F = V_{EC}$	$I_{Fnom} = 400 \text{ A}; V_{GE} = 0 \text{ V}$	$T_j = 25 \text{ }^\circ\text{C}_{chiplev.}$	1,65	2	V
		$T_j = 125 \text{ }^\circ\text{C}_{chiplev.}$	1,65	2	V
V_{F0}		$T_j = 125 \text{ }^\circ\text{C}$		0,9	V
r_F		$T_j = 125 \text{ }^\circ\text{C}$		3	V
I_{RRM}	$I_F = 300 \text{ A}$	$T_j = 125 \text{ }^\circ\text{C}$	130		A
Q_{rr}			23		μC
E_{rr}	$V_{GE} = -15 \text{ V}; V_{CC} = 300 \text{ V}$				mJ
$R_{th(j-c)FD}$	per diode			0,15	K/W
Module					
L_{CE}			15	20	nH
$R_{CC+EE'}$	res., terminal-chip	$T_{case} = 25 \text{ }^\circ\text{C}$	0,35		mΩ
		$T_{case} = 125 \text{ }^\circ\text{C}$	0,5		mΩ
$R_{th(c-s)}$	per module			0,038	K/W
M_s	to heat sink M6		3	5	Nm
M_t	to terminals M6		2,5	5	Nm
w				325	g

This is an electrostatic discharge sensitive device (ESDS), international standard IEC 60747-1, Chapter IX.

* The specifications of our components may not be considered as an assurance of component characteristics. Components have to be tested for the respective application. Adjustments may be necessary. The use of SEMIKRON products in life support appliances and systems is subject to prior specification and written approval by SEMIKRON. We therefore strongly recommend prior consultation of our personal.

SKM 300GB063D

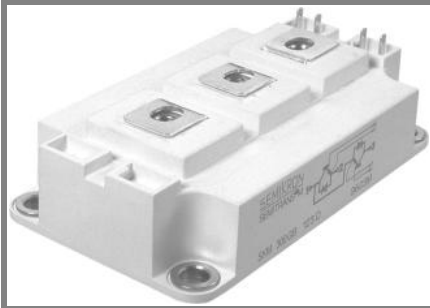

SEMITRANS® 3

Superfast IGBT Modules

SKM 300GB063D

SKM 300GAR063D

SKM 300GAL063D

Features

- NPT- Non punch-through IGBT
- Low tail current with low temperature dependence
- High short circuit capability, self limiting if term. G is clamped to E
- Pos. temp.-coeff. of V_{CEsat}
- 50 % less turn off losses
- 30 % less short circuit current
- Very low C_{ies} , C_{oes} , C_{res}
- Latch-up free
- Fast & soft inverse CAL diodes
- Isolated copper baseplate using DCB Direct Copper Bonding Technology without hard mould
- Large clearance (13 mm) and creepage distances (20 mm)

Typical Applications*

- Switching (not for linear use)
- Switched mode power supplies
- AC inverter servo drives
- UPS uninterruptable power supplies
- Welding inverters

Z_{th}		Conditions	Values	Units
$Z_{th(j-c)I}$				
$R_{\theta j-c}$		i = 1	65	mk/W
$R_{\theta j-c}$		i = 2	19	mk/W
$R_{\theta j-c}$		i = 3	4,7	mk/W
$R_{\theta j-c}$		i = 4	1,3	mk/W
$\tau_{th(j-c)}$		i = 1	0,0518	s
$\tau_{th(j-c)}$		i = 2	0,0241	s
$\tau_{th(j-c)}$		i = 3	0,0021	s
$\tau_{th(j-c)}$		i = 4	0,0001	s
$Z_{th(j-c)D}$				
$R_{\theta j-cD}$		i = 1	140	mk/W
$R_{\theta j-cD}$		i = 2	85	mk/W
$R_{\theta j-cD}$		i = 3	20,55	mk/W
$R_{\theta j-cD}$		i = 4	4,45	mk/W
$\tau_{th(j-c)D}$		i = 1	0,0613	s
$\tau_{th(j-c)D}$		i = 2	0,0041	s
$\tau_{th(j-c)D}$		i = 3	0,0045	s
$\tau_{th(j-c)D}$		i = 4	0,0003	s

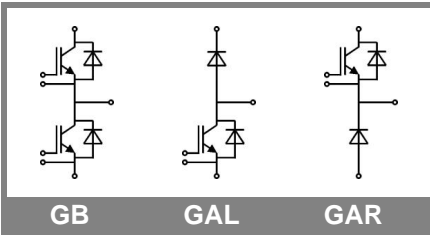

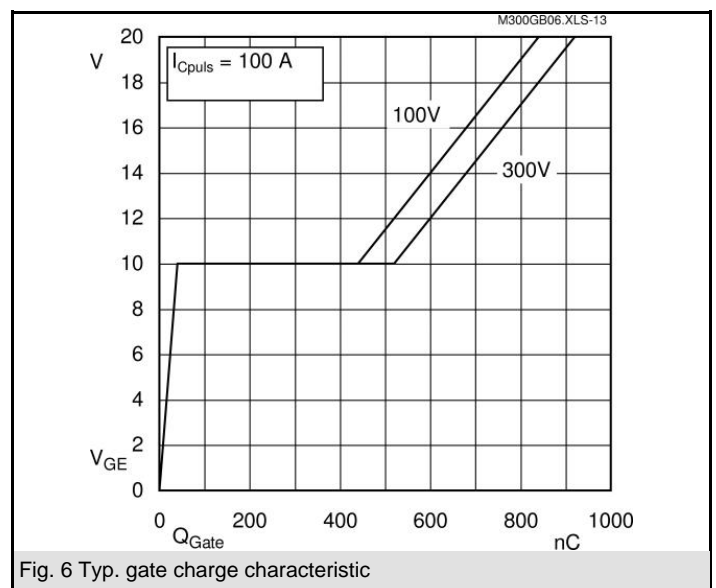
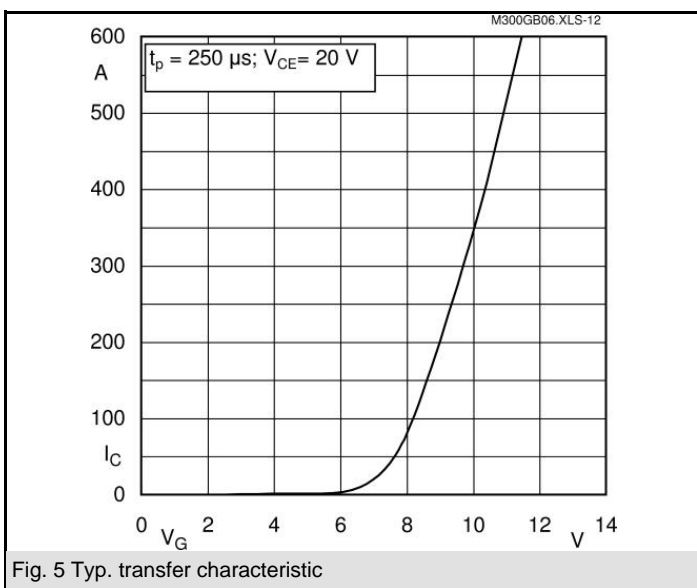
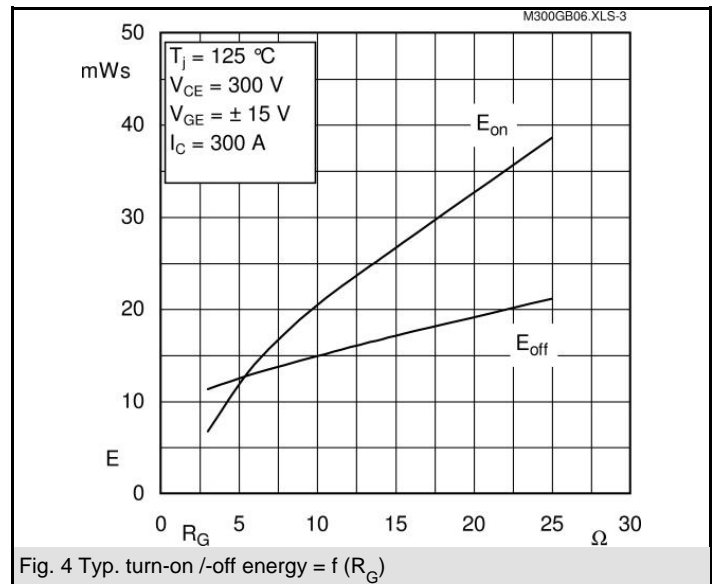
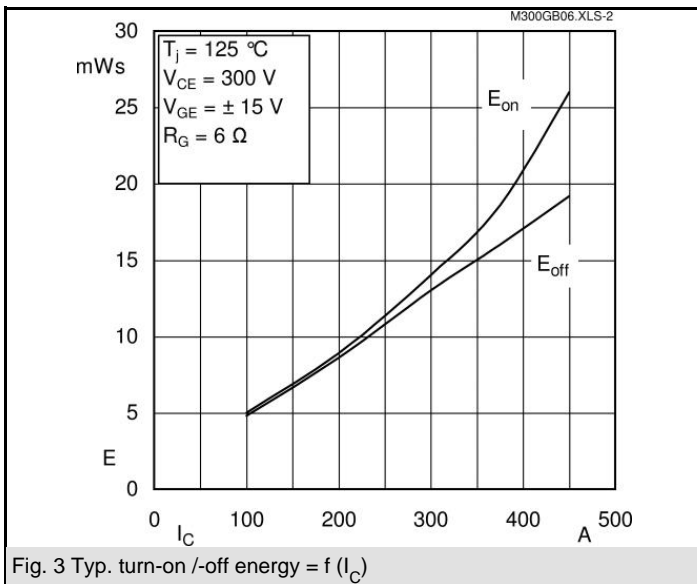
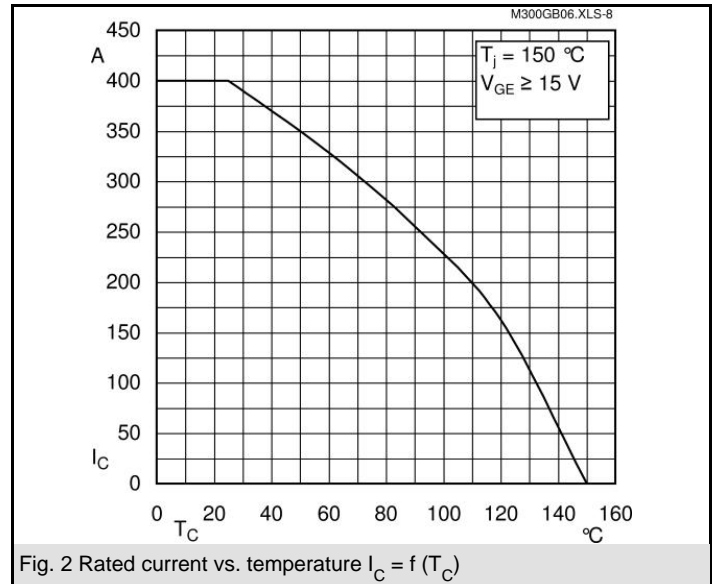
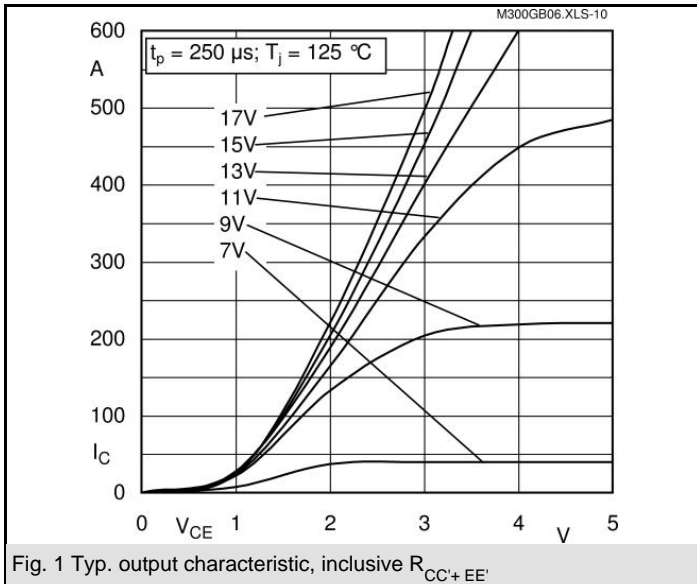

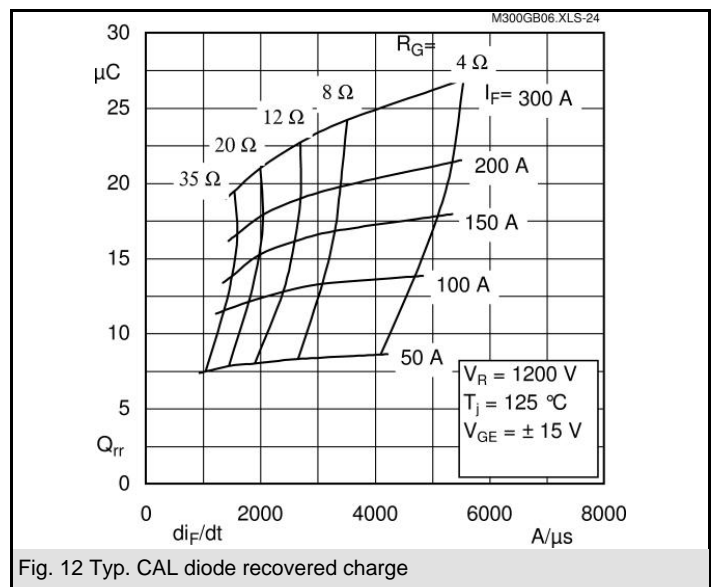
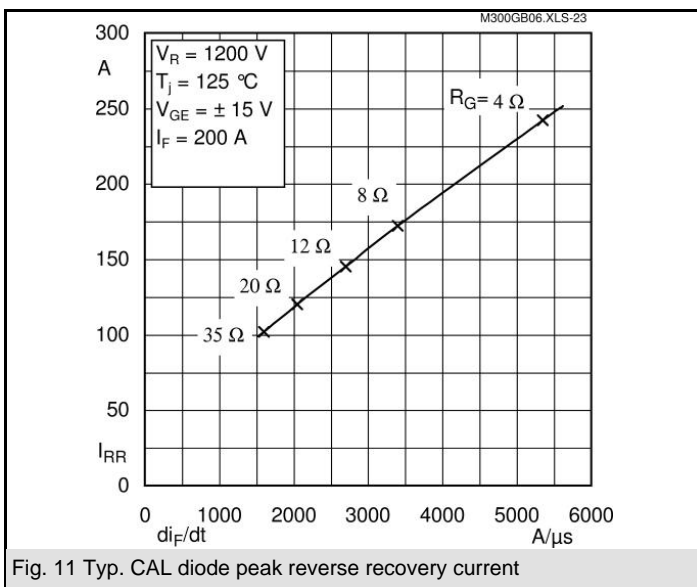
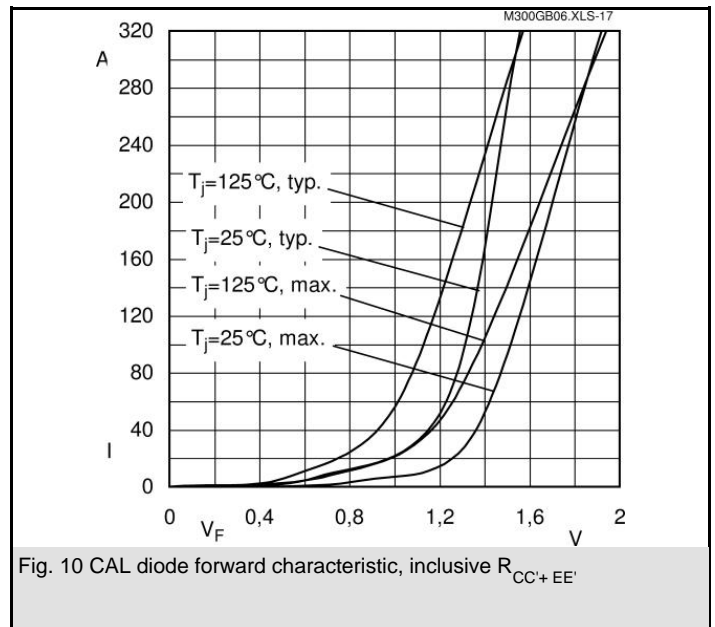
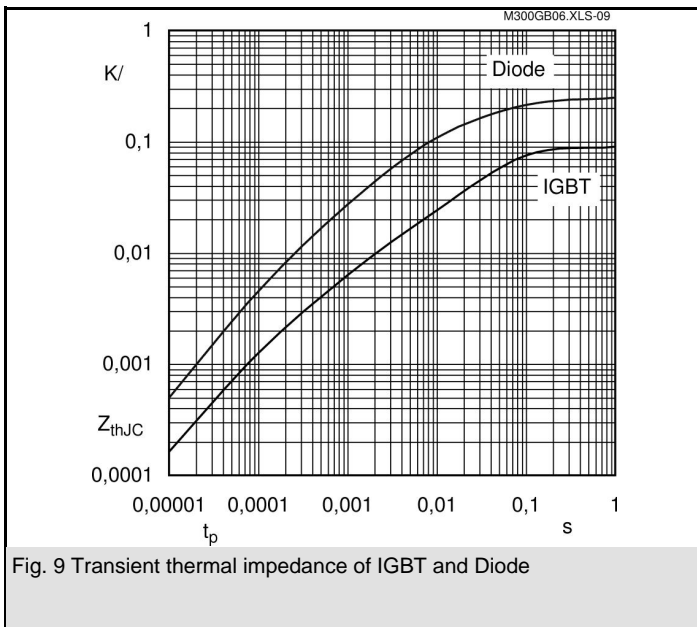
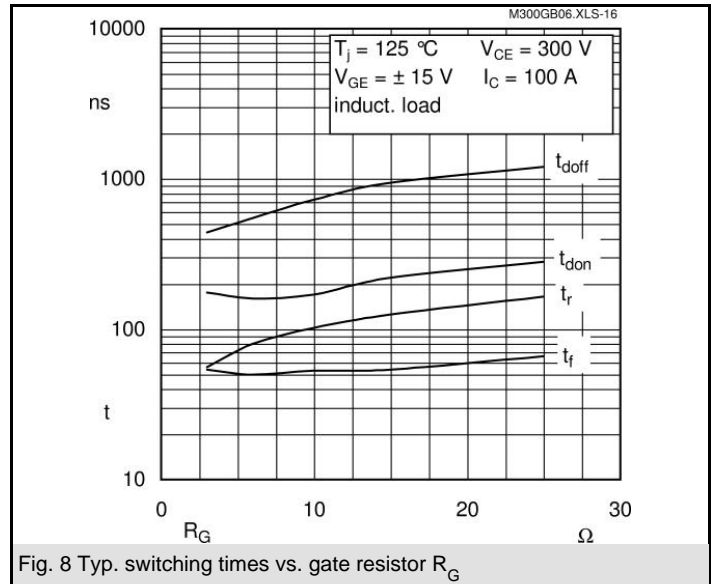
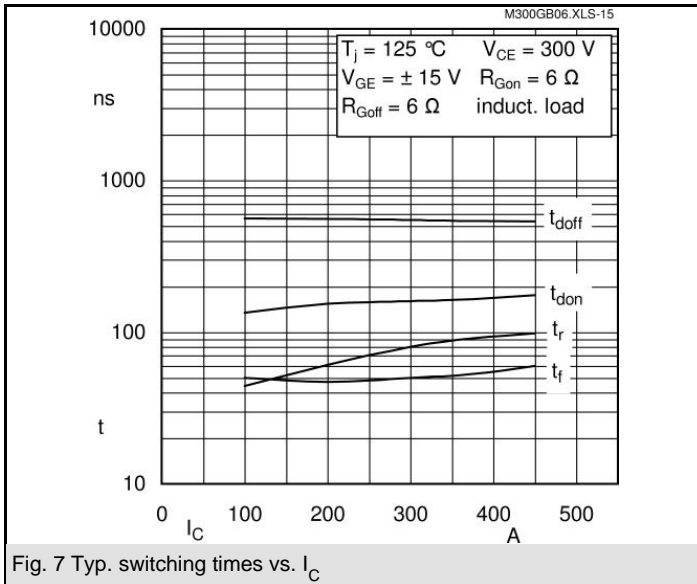

SKM 300GB063D

UL Recognized

CASED56

File no. E 63 532

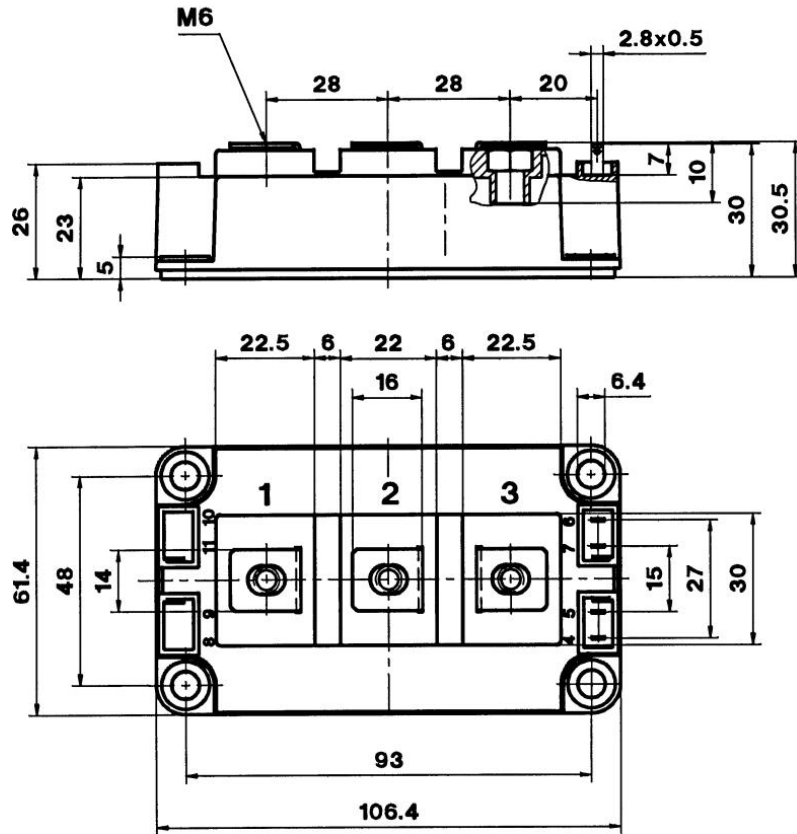

Case D 56

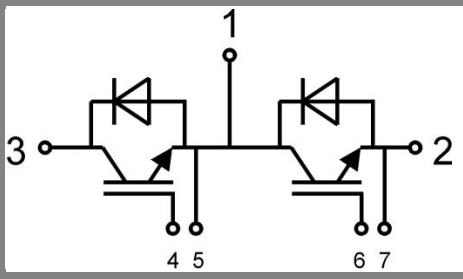

GB

Case D 56

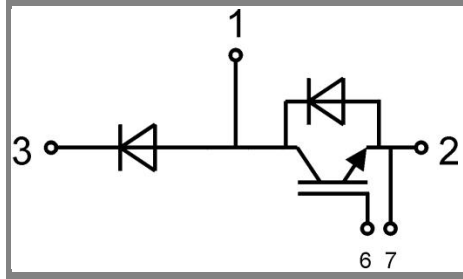

GAL

Case D 57 (→ D 56)

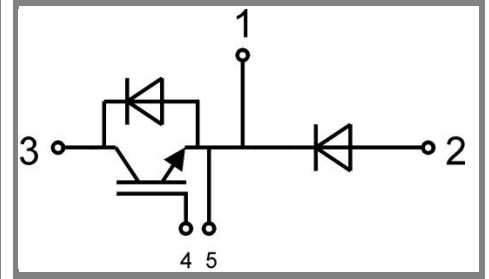

GAR

Case D 58 (→ D 56)