

SKM 180A020



SEMITRANS™ M1

Power MOSFET Modules

SKM 180A020

Features

- N Channel, enhancement mode
- Avalanche characteristics
- Short internal connections avoid oscillations
- Isolated copper baseplates
- All electrical connections on top for easy busbaring
- Large clearance (10mm) and creepage distances (13mm)
- UL recognized, file no. E 63 532

Typical Applications*

- Switched mode power supplies
- DC servo and robot drives
- DC choppers
- UPS equipment
- Plasma cutting
- Not suitable for linear amplification

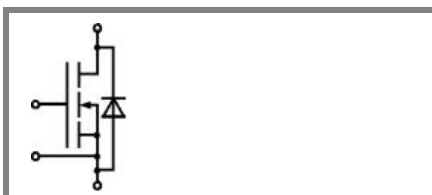

MA

Absolute Maximum Ratings		$T_c = 25\text{ °C}$, unless otherwise specified	
Symbol	Conditions	Values	Units
V_{DS}		200	V
I_D	$T_s = 25\text{ (80) °C}$	180 (135)	A
I_{DM}	1 ms	540	A
V_{GS}		± 20	V
T_{vj} (T_{stg})		- 40 ... + 150 (125)	°C
V_{isol}	AC, 1 min.	2500	V
Inverse diode			
$I_F = -I_S$		180	A
$I_{FM} = -I_{SM}$		540	A

Characteristics		$T_c = 25\text{ °C}$, unless otherwise specified			
Symbol	Conditions	min.	typ.	max.	Units
$V_{(BR)DSS}$	$V_{GS} = 0\text{ V}$, $I_D = 0,25\text{ mA}$	200			V
$V_{GS(th)}$	$V_{GS} = V_{DS}$, $I_D = 1\text{ mA}$	2,1	3	4	V
I_{DSS}	$V_{GS} = 0\text{ V}$, $V_{DS} = 200\text{ V}$, $T_j = 25\text{ (125) °C}$		50 (300)	250 (1000)	μA
I_{GSS}	$V_{GS} = 20\text{ V}$, $V_{DS} = 0\text{ V}$		10	100	nA
$R_{DS(on)}$	$V_{GS} = 10\text{ V}$, $I_D = 110\text{ A}$		9	11	m Ω
g_{fs}	$V_{DS} = 25\text{ V}$, $I_D = 110\text{ A}$	80	100		S
C_{CHC}	$V_{GS} = 0$, $V_{DS} = 25\text{ V}$, $f = 1\text{ MHz}$			160	pF
C_{iss}			16	24	nF
C_{oss}			3	4,5	nF
C_{rss}			1,5	2	nF
L_{DS}				20	nH
$t_{d(on)}$	$V_{DD} = 100\text{ V}$, $I_D = 80\text{ A}$,		100		ns
t_r	$V_{GS} = 10\text{ V}$, $R_G = 3,3\ \Omega$		200		ns
$t_{d(off)}$			900		ns
t_f			220		ns
Inverse diode					
V_{SD}	$I_F = 360\text{ A}$; $V_{GS} = 0\text{ V}$		1,3	1,5	V
t_{rr}	$T_j = 25\text{ (125) °C}$		500		ns
Q_{rr}	$T_j = 25\text{ °C}$		10 (12)		μC
I_{rr}	$T_j = \text{ °C}$				A
Thermal characteristics					
$R_{th(j-c)}$	per MOSFET			0,18	K/W
$R_{th(c-s)}$	M_s , surface 10 μm , per module			0,05	K/W
Mechanical data					
M_s	to heatsink (M6)	4		5	Nm
M_t	for terminals (M5)				Nm
w				130	g

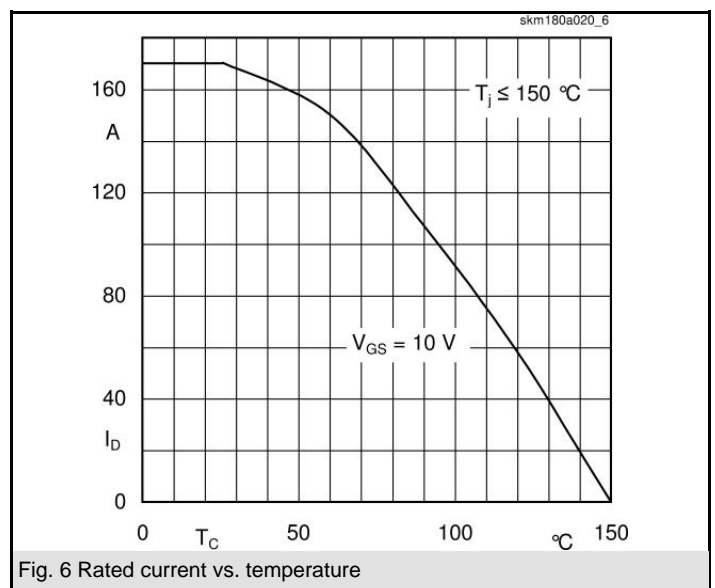
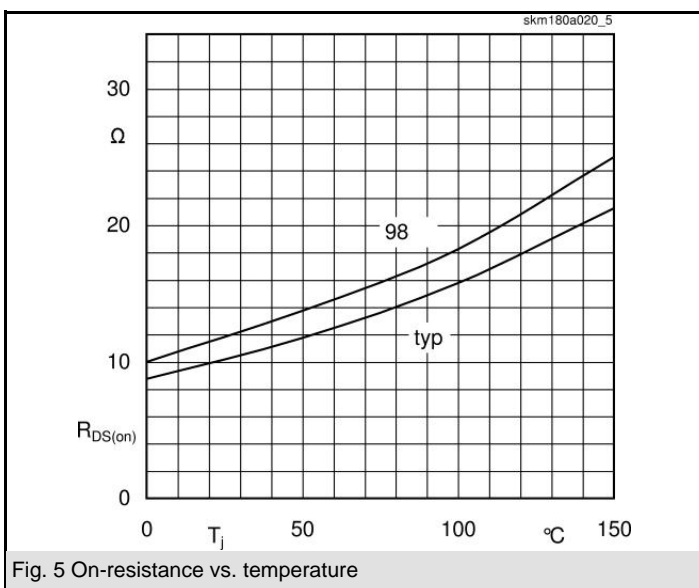
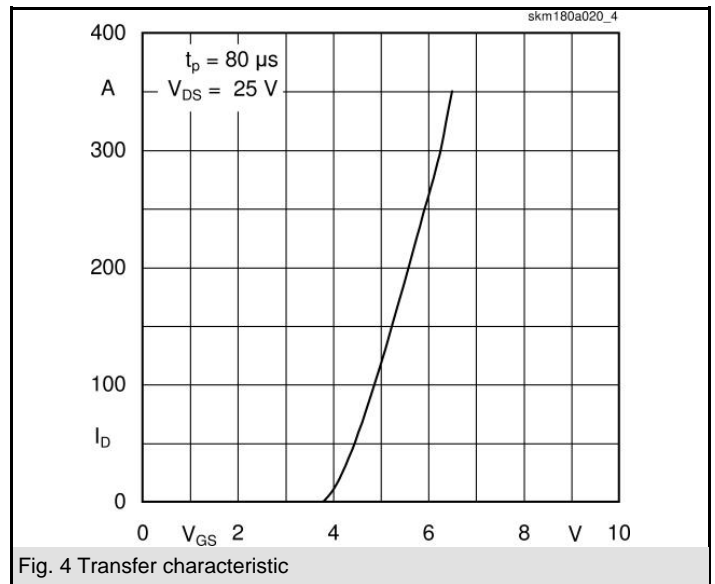
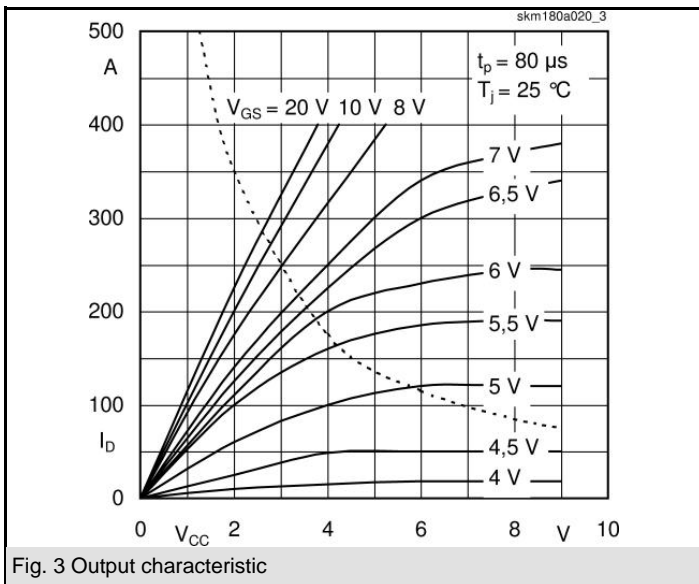
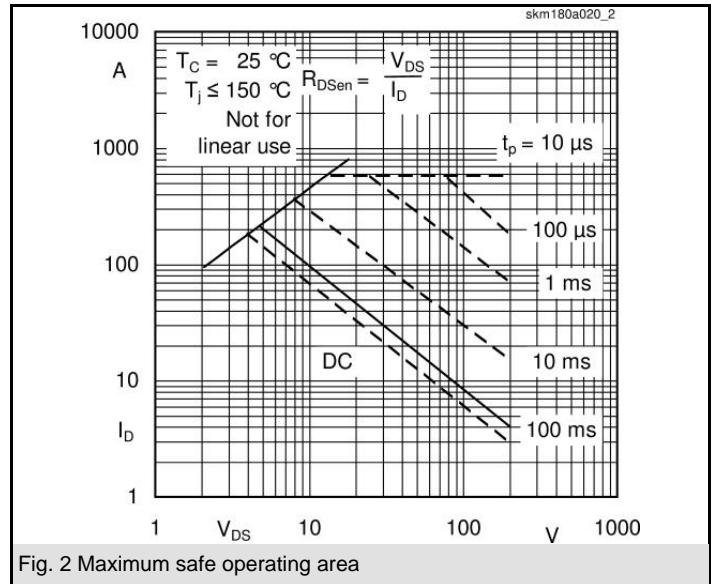
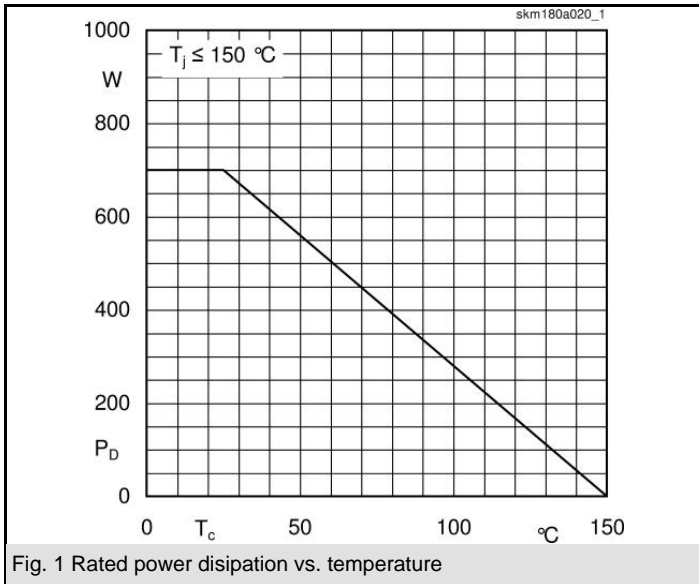

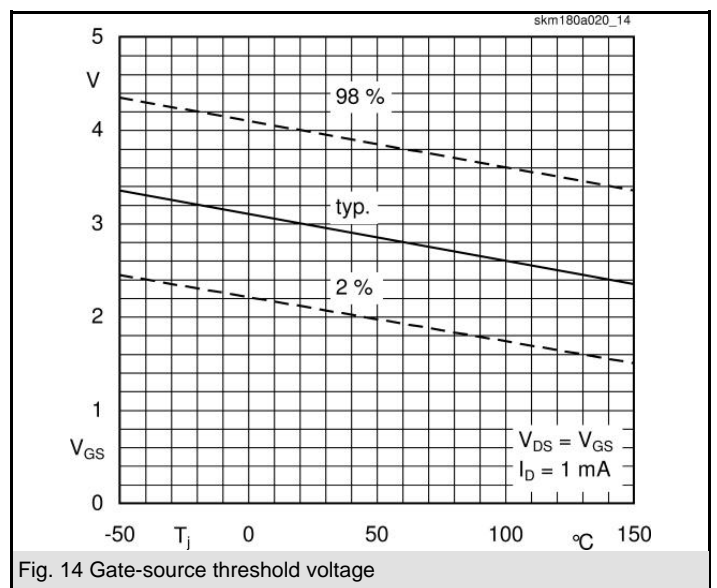
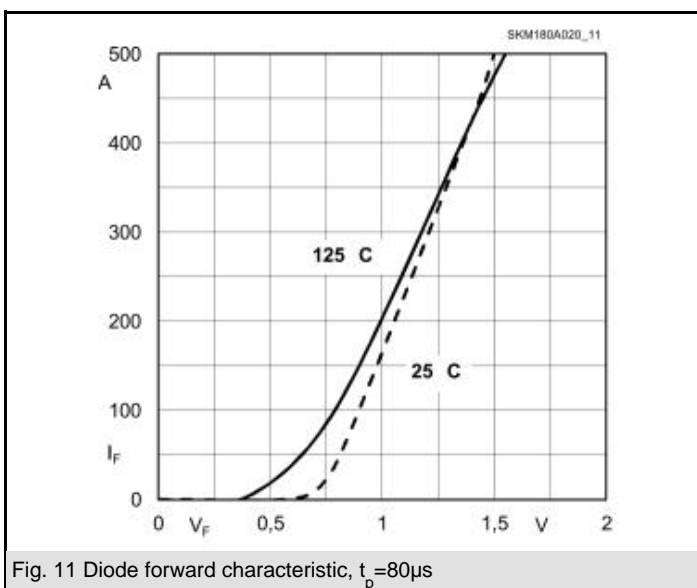
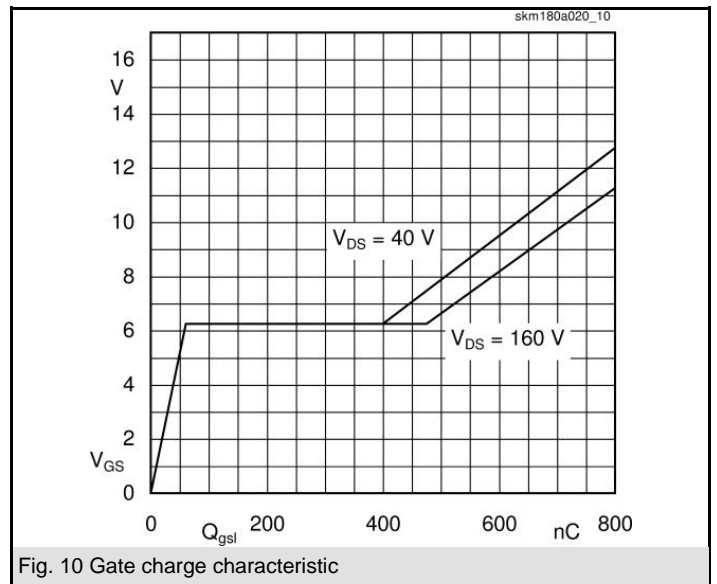
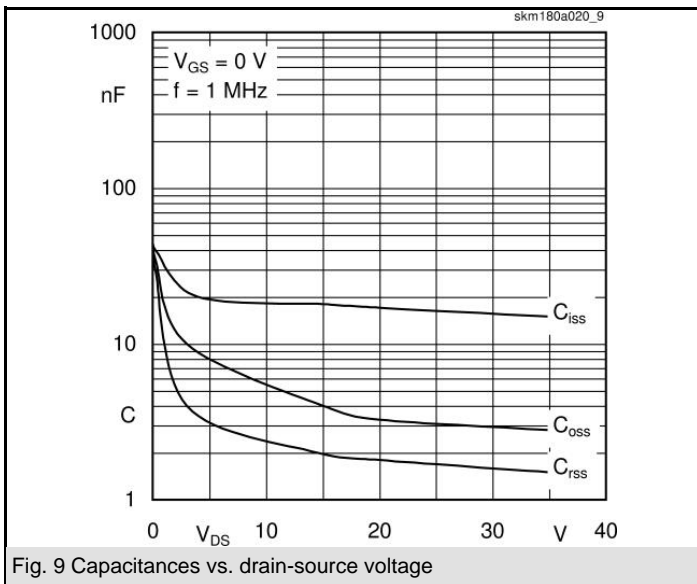
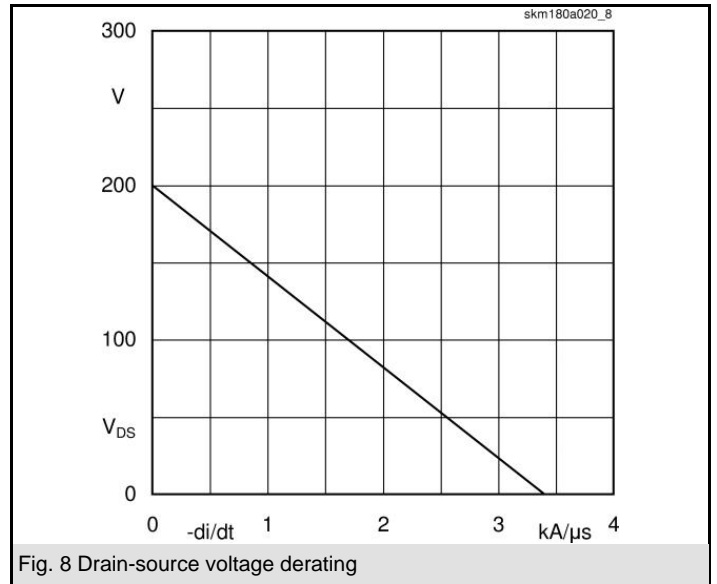
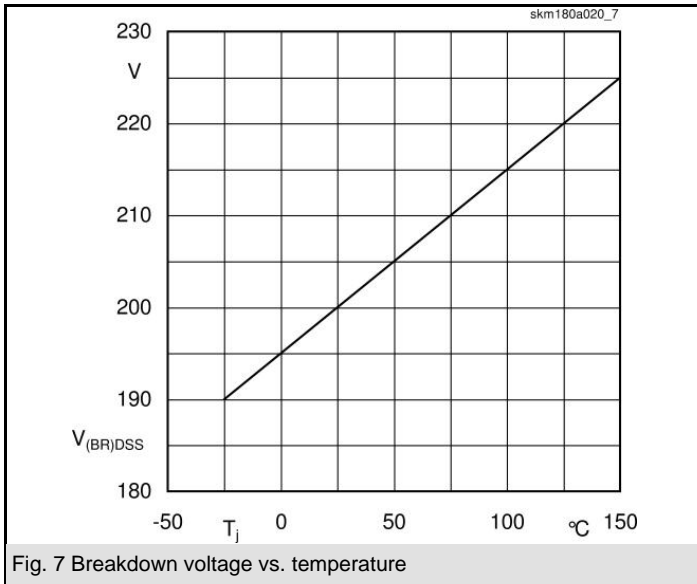

SKM 180A020

UL Recognized
File no. E 63 532

Dimensions in mm

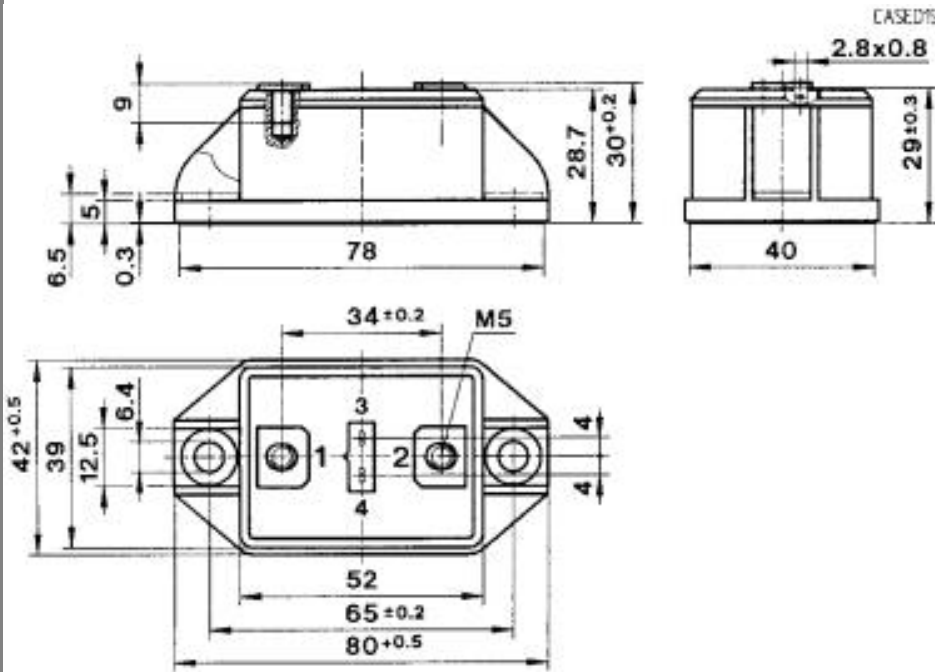

Case D15

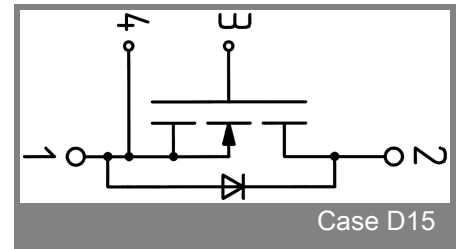

Case D15

This is an electrostatic discharge sensitive device (ESDS), international standard IEC 60747-1, Chapter IX.

* The specifications of our components may not be considered as an assurance of component characteristics. Components have to be tested for the respective application. Adjustments may be necessary. The use of SEMIKRON products in life support appliances and systems is subject to prior specification and written approval by SEMIKRON. We therefore strongly recommend prior consultation of our staff.