

SKM 145GB124DN

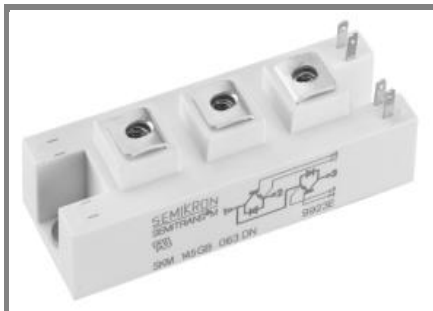

SEMITRANS™ 2N

Low Loss IGBT Modules

SKM 145GB124DN

SKM 145GAL124DN

Features

- N channel, homogeneous Si - structure (NPT - Non punch-trough IGBT)
- High short circuit capability, self limiting to $6 \times I_{Cnom}$
- Fast & soft inverse CAL diodes
- Without hard mould
- Large clearance (10 mm) and creepage distances (20 mm)

Typical Applications

- Switching (not for linear use)
- Switched mode power supplies
- DC servo and robot supplies
- Inverters
- DC choppers
- AC motor speed control
- UPS
- General power switching applications

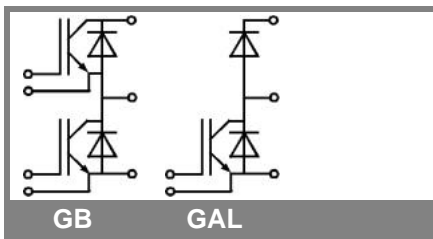

Absolute Maximum Ratings		$T_c = 25\text{ }^\circ\text{C}$, unless otherwise specified	
Symbol	Conditions	Values	Units
IGBT			
V_{CES}		1200	V
I_C	$T_c = 25\text{ (80) }^\circ\text{C}$	190 (130)	A
I_{CRM}	$t_p = 1\text{ ms}$	200	A
V_{GES}		± 20	V
T_{vj} (T_{stg})	$T_{OPERATION} \leq T_{stg}$	- 40 ... + 150 (125)	$^\circ\text{C}$
V_{isol}	AC, 1 min.	2500	V
Inverse diode			
I_F	$T_c = 25\text{ (80) }^\circ\text{C}$	120 (95)	A
I_{FRM}	$t_p = 1\text{ ms}$	200	A
I_{FSM}	$t_p = 10\text{ ms}$; sin.; $T_j = 150\text{ }^\circ\text{C}$	1100	A
Freewheeling diode			
I_F	$T_c = 25\text{ (80) }^\circ\text{C}$	120 (95)	A
I_{FRM}	$t_p = \text{ms}$	200	A
I_{FSM}	$t_p = \text{ms}$; ; $T_j = \text{ }^\circ\text{C}$	1100	A

Characteristics		$T_c = 25\text{ }^\circ\text{C}$, unless otherwise specified			
Symbol	Conditions	min.	typ.	max.	Units
IGBT					
$V_{GE(th)}$	$V_{GE} = V_{CE}$, $I_C = 4\text{ mA}$	4,5	5,5	6,5	V
I_{CES}	$V_{GE} = 0$, $V_{CE} = V_{CES}$, $T_j = 25\text{ (125) }^\circ\text{C}$		0,1	0,3	mA
$V_{CE(TO)}$	$T_j = 25\text{ (125) }^\circ\text{C}$		1,1 (1,1)	1,25 (1,25)	V
r_{CE}	$V_{GE} = 15\text{ V}$, $T_j = 25\text{ (125) }^\circ\text{C}$		10 (13)	12 (16)	m Ω
$V_{CE(sat)}$	$I_{Cnom} = 100\text{ A}$, $V_{GE} = 15\text{ V}$, chip level		2,1 (2,4)	2,45 (2,85)	V
C_{ies}	under following conditions		6,5	8,5	nF
C_{oes}	$V_{GE} = 0$, $V_{CE} = 25\text{ V}$, $f = 1\text{ MHz}$		1	1,5	nF
C_{res}			0,5	0,6	nF
L_{CE}				25	nH
$R_{CC'+EE'}$	res., terminal-chip $T_c = \text{ }^\circ\text{C}$				m Ω
$t_{d(on)}$	$V_{CC} = 600\text{ V}$, $I_{Cnom} = 100\text{ A}$		110		ns
t_r	$R_{Gon} = R_{Goff} = 8\text{ }^\circ\Omega$, $T_j = 125\text{ }^\circ\text{C}$		50		ns
$t_{d(off)}$	$V_{GE} = \pm 15\text{ V}$		470		ns
t_f			60		ns
E_{on} (E_{off})			14 (13)		mJ
Inverse diode					
$V_F = V_{EC}$	$I_{Fnom} = 100\text{ A}$; $V_{GE} = 0\text{ V}$; $T_j = 25\text{ (125) }^\circ\text{C}$		2 (1,8)	2,5	V
$V_{(TO)}$	$T_j = 25\text{ (125) }^\circ\text{C}$		1,1	1,2	V
r_T	$T_j = 25\text{ (125) }^\circ\text{C}$		9	13	m Ω
I_{RRM}	$I_{Fnom} = 100\text{ A}$; $T_j = 125\text{ () }^\circ\text{C}$		100		A
Q_{rr}	$di/dt = 2600\text{ A}/\mu\text{s}$		15		μC
E_{rr}	$V_{GE} = 0\text{ V}$		5,4		mJ
FWD					
$V_F = V_{EC}$	$I_F = 100\text{ A}$; $V_{GE} = 0\text{ V}$, $T_j = 25\text{ (125) }^\circ\text{C}$		2 (1,8)	2,5	V
$V_{(TO)}$	$T_j = 25\text{ (125) }^\circ\text{C}$		1,1	1,2	V
r_T	$T_j = 25\text{ (125) }^\circ\text{C}$		9	13	m Ω
I_{RRM}	$I_F = 100\text{ A}$; $T_j = 125\text{ () }^\circ\text{C}$		100		A
Q_{rr}	$di/dt = 2600\text{ A}/\mu\text{s}$		15		μC
E_{rr}	$V_{GE} = 0\text{ V}$		5,4		mJ
Thermal characteristics					
$R_{th(j-c)}$	per IGBT			0,16	K/W
$R_{th(j-c)D}$	per Inverse Diode			0,32	K/W
$R_{th(j-c)FD}$	per FWD			0,32	K/W
$R_{th(c-s)}$	per module			0,05	K/W
Mechanical data					
M_s	to heatsink M6	3		5	Nm
M_t	to terminals M5	2,5		5	Nm
w				160	g

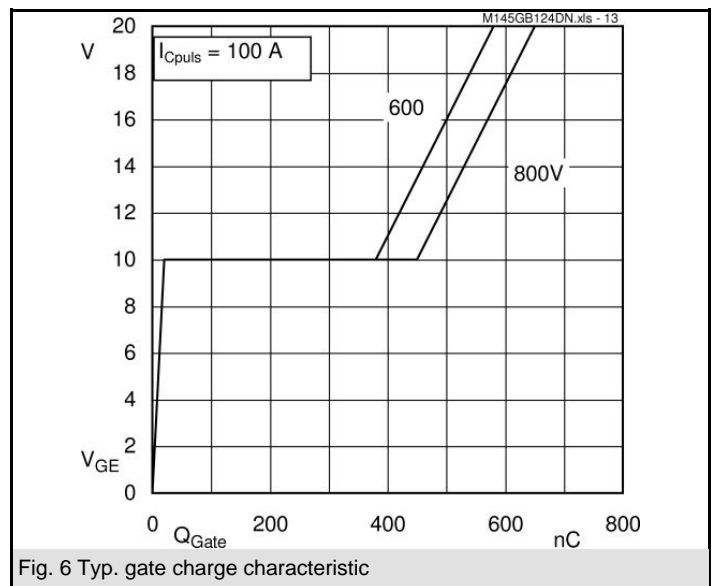
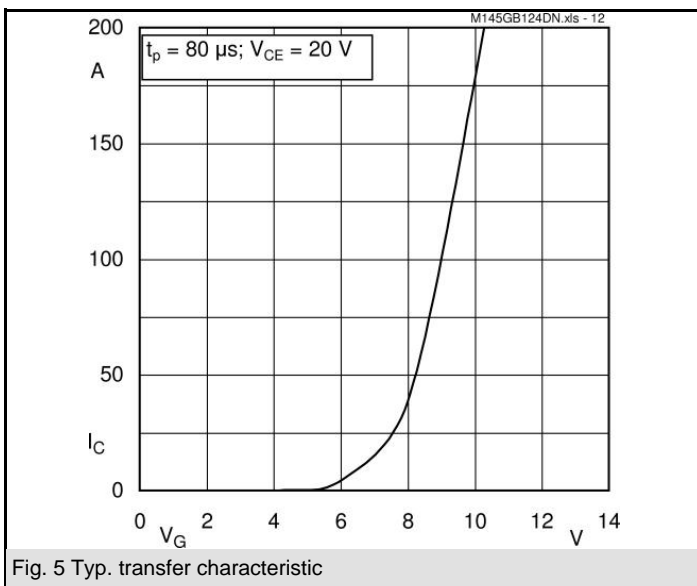
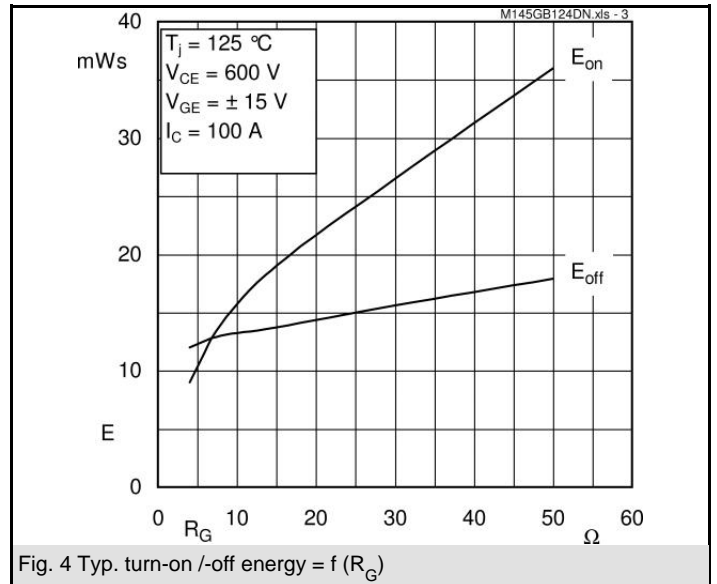
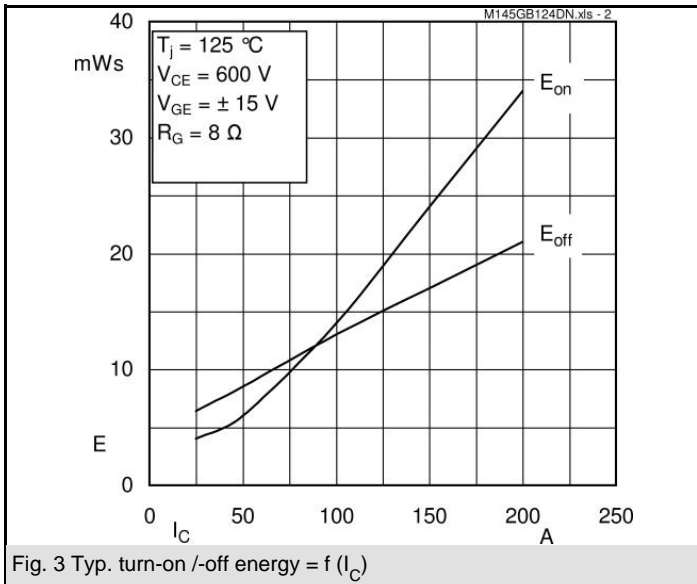
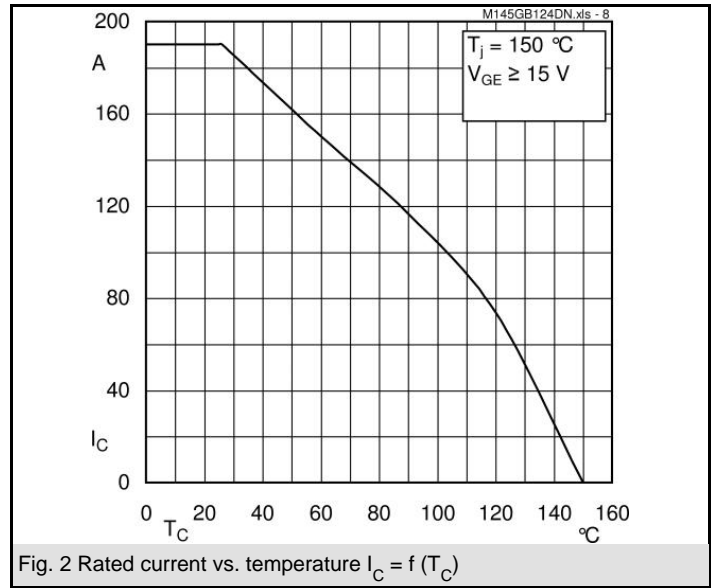
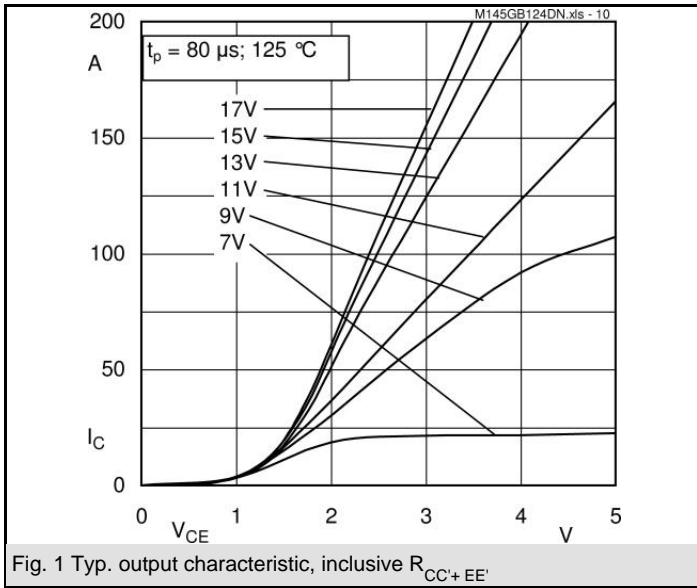

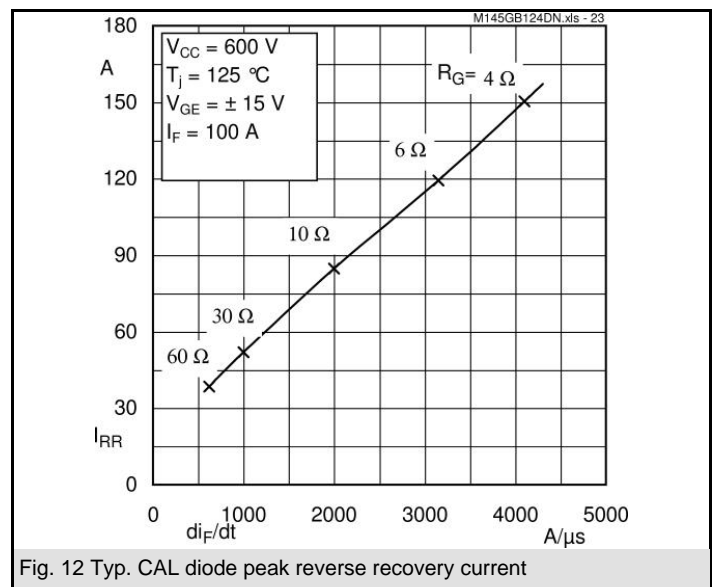
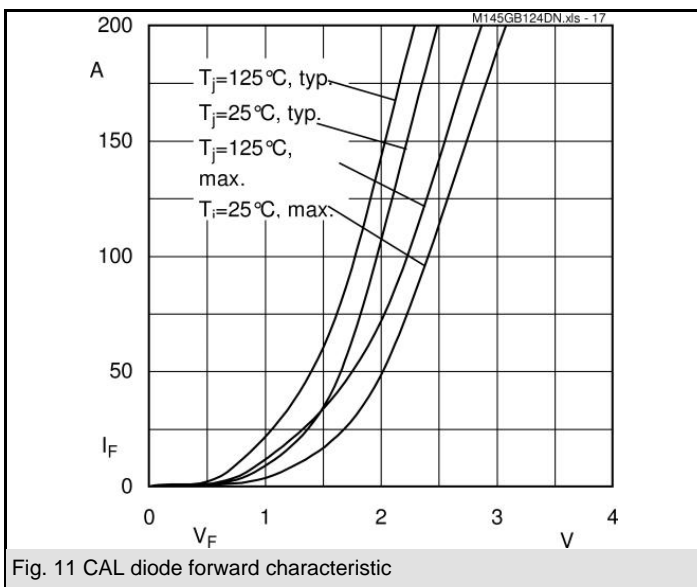
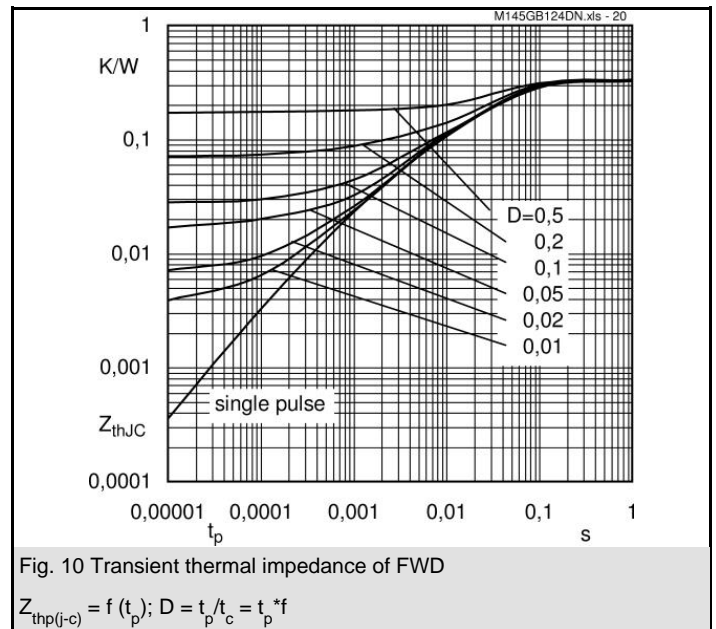
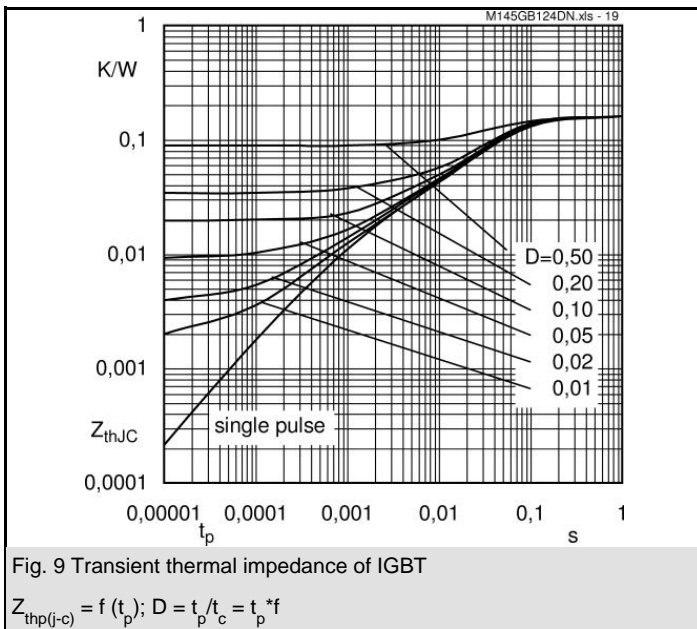
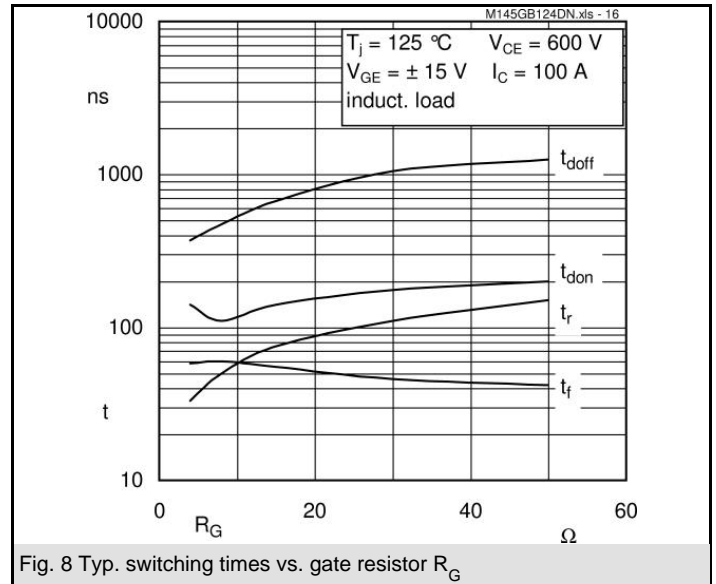
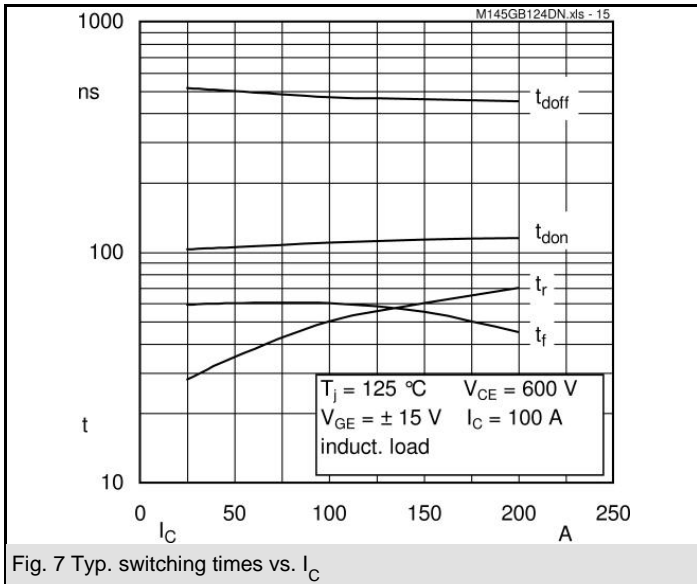

SKM 145GB124DN

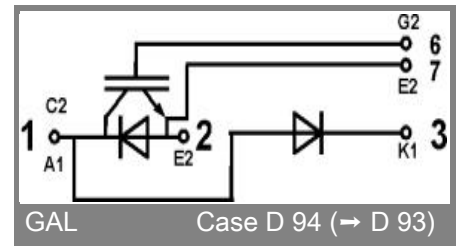
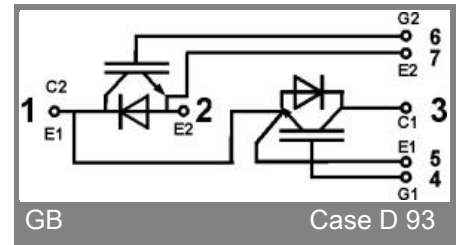
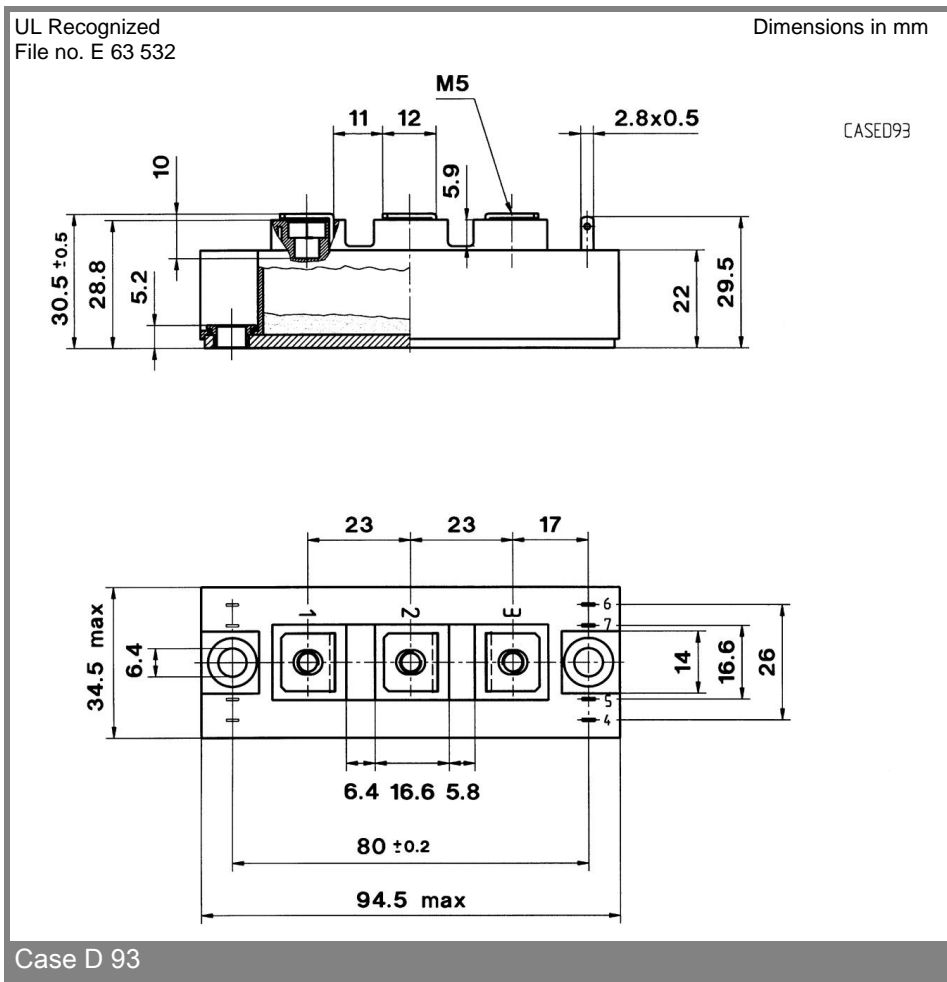
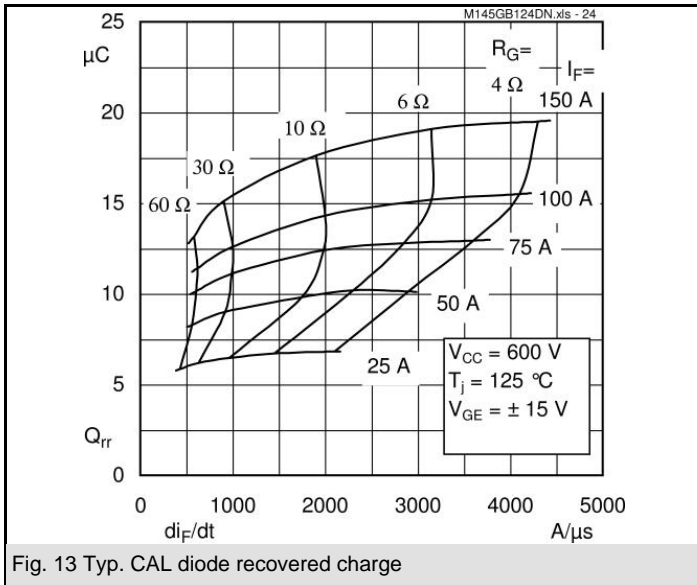

This is an electrostatic discharge sensitive device (ESDS), international standard IEC 60747-1, Chapter IX.

This technical information specifies semiconductor devices but promises no characteristics. No warranty or guarantee expressed or implied is made regarding delivery, performance or suitability.