

V _{RSM}	V _{RRM}	(dv/dt) _{cr}	I _{TRMS} (maximum values for continuous operation)			
			350 A	420 A	350 A	420 A
V	V	V/μs	I _{TAV} (sin. 180; T _{case} = . . .)			
			220 A (88 °C)	260 A (82 °C)	220 A (88 °C)	260 A (82 °C)
			SKKT	SKKT	SKKH	SKKH
900	800	500	210/08 D	250/08 D	–	–
1300	1200	1000	210/12 E	250/12 E	210/12 E	250/12 E
1500	1400	1000	210/14 E	250/14 E	210/14 E	250/14 E
1700	1600	1000	210/16 E	250/16 E	210/16 E	250/16 E
1900	1800	1000	210/18 E	250/18 E	210/18 E	250/18 E
2100	2000	1000	210/20 E	–	210/20 E	–
2300	2200	1000	210/22 E	–	210/22 E	–

SEMIPACK® 3 Thyristor / Diode Modules

SKKT 210 **SKKH 210**
SKKT 250 **SKKH 250**
SKMT 250¹⁾



Symbol	Conditions	SKKT 210 SKKH 210	SKKT 250 SKKH 250	Units
I _{TAV}	sin. 180; (T _{case} = ...)	210 (90°C)	250 (85°C)	A
I _D	B2/B6 T _{amb} = 35 °C; P 16/170 F	420/550	450/585	A
I _{RMS}	W1/W3 T _{amb} = 35 °C; P 16/170 F	526/3 x 440	566/3 x 471	A
I _{TSM}	T _{vj} = 25 °C; 10 ms	8 500	9 000	A
	T _{vj} = 130 °C; 10 ms	7 500	8 000	A
i ² t	T _{vj} = 25 °C; 8,3 ... 10 ms	361 000	405 000	A ² s
	T _{vj} = 130 °C; 8,3 ... 10 ms	281 000	320 000	A ² s
t _{gd}	T _{vj} = 25 °C; I _G = 1 A di _G /dt = 1 A/μs	1		μs
t _{gr}	V _D = 0,67 · V _{DRM}	2		μs
(di/dt) _{cr}	T _{vj} = 130 °C	250		A/μs
t _q	T _{vj} = 130 °C	typ. 50 ... 150		μs
I _H	T _{vj} = 25 °C; typ. / max.	150 / 500		mA
I _L	T _{vj} = 25 °C; R _G = 33 Ω; typ. / max.	0,3 / 2		A
V _T	T _{vj} = 25 °C; I _T = 750 A	max. 1,5	max. 1,4	V
V _{T(TO)}	T _{vj} = 130 °C	0,95	0,925	V
r _T	T _{vj} = 130 °C	0,6	0,45	mΩ
I _{DD} ; I _{RD}	T _{vj} = 130 °C; V _{RD} = V _{RRM} V _{DD} = V _{DRM}	50	50	mA
V _{GT}	T _{vj} = 25 °C; d.c.	3		V
I _{GT}	T _{vj} = 25 °C; d.c.	200		mA
V _{GD}	T _{vj} = 130 °C; d.c.	0,25		V
I _{GD}	T _{vj} = 130 °C; d.c.	10		mA
R _{thjc}	cont. } sin. 180 } per thyristor / rec. 120 } per module	0,14 / 0,07		°C/W
		0,15 / 0,075		°C/W
		0,165 / 0,083		°C/W
R _{thch}		0,04 / 0,02		°C/W
T _{vj} , T _{stg}		– 40 ... + 130		°C
V _{isol}	a. c. 50 Hz; r.m.s.; 1 s/1 min	3600 / 3000		V~
M ₁	to heatsink } SI (US) units	5 (44 lb. in.) ± 15 % ²⁾		Nm
M ₂	to terminals }	9 (80 lb. in.) ± 15 % ³⁾		Nm
a		5 · 9,81		m/s ²
w	approx.	940		g
Case	→ page B 1 – 80	SKKT: A 25 SKKH: A 26 SKMT: A 64		



SKKT

SKKH

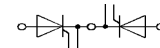

SKMT

Features

- Heat transfer through aluminium nitride ceramic isolated metal baseplate
- Precious metal pressure contacts for high reliability
- Thyristor with amplifying gate
- UL recognized, file no. E 63 532

Typical Applications

- DC motor control (e.g. for machine tools)
- Temperature control (e.g. for ovens, chemical processes)
- Professional light dimming (studios, theaters)

¹⁾ SKMT 250 available on request

²⁾ See the assembly instructions

³⁾ The screws must be lubricated

SKKT 210, SKKT 250

Case A 25

SEMIPACK 3

UL recognized, file no. E 63 532

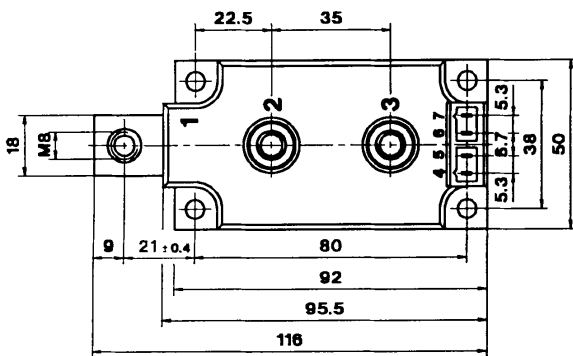
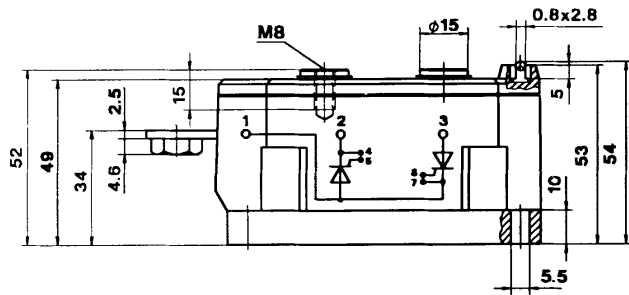

SKKE 260

Case A 28

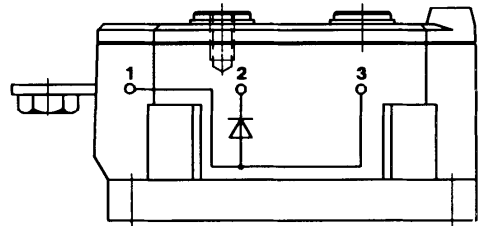

SKKL 210, SKKL 250

Case A 35

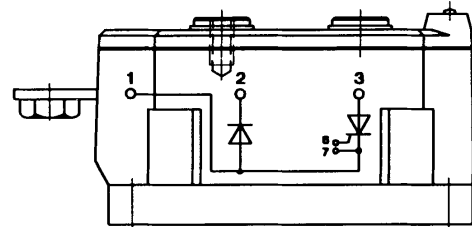

SKKH 210, SKKH 250

Case A 26

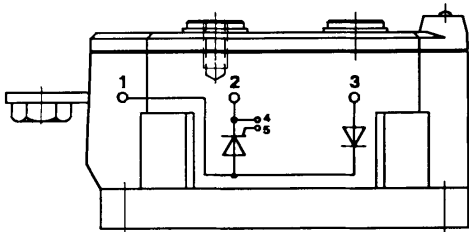

SKMD 260

Case A 58

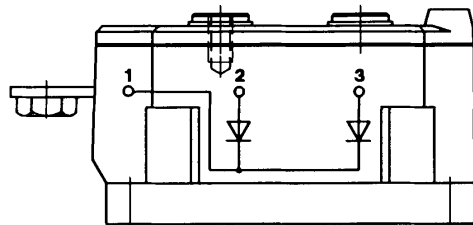

SKKD 260

Case A 27

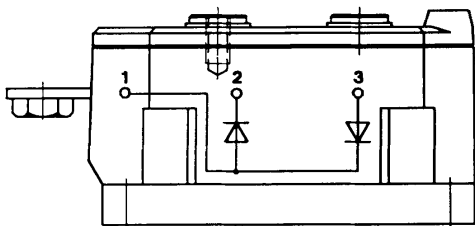

SKMT 250

Case A 64

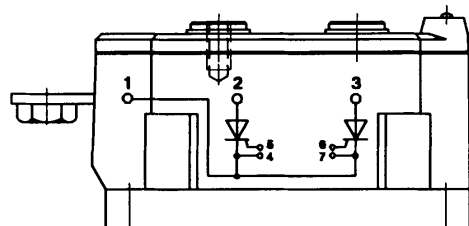

Dimensions in mm