

SKKT 500, SKKH 500



SEMIPACK® 5

Thyristor / Diode Modules

SKKT 500

SKKH 500

Features

- Heat transfer through aluminium nitride ceramic isolated metal baseplate
- Precious metal pressure contacts for high reliability
- UL recognized, file no. E 63 532

Typical Applications

- AC motor softstarters
- Input converters for AC inverter drives
- DC motor control (e. g. for machine tools)
- Temperature control (e. g. for ovens, chemical processes)
- Professional light dimming (studios, theaters)

- 1) See the assembly instructions
- 2) The screws must be lubricated

V_{RSM} V	V_{RRM}, V_{DRM} V	$I_{TRMS} = 920$ A (maximum value for continuous operation) $I_{TAV} = 500$ A (sin. 180; $T_c = 89$ °C)	
900	800	SKKT 500/08E	SKKH 500/08E
1300	1200	SKKT 500/12E	SKKH 500/12E
1500	1400	SKKT 500/14E	SKKH 500/14E
1700	1600	SKKT 500/16E	SKKH 500/16E
1900	1800	SKKT 500/18E	SKKH 500/18E

Symbol	Conditions	Values	Units
I_{TAV}	sin. 180; $T_c = 85$ (100) °C;	540 (390)	A
I_D	P16/200F; $T_a = 35$ °C; B2 / B6	665 / 845	A
I_{RMS}	P16/300F; $T_a = 35$ °C; W1 / W3	850 / 3 * 670	A
I_{TSM}	$T_{vj} = 25$ °C; 10 ms	17000	A
	$T_{vj} = 130$ °C; 10 ms	15000	A
i^2t	$T_{vj} = 25$ °C; 8,3 ... 10 ms	1445000	A ² s
	$T_{vj} = 130$ °C; 8,3 ... 10 ms	1125000	A ² s
V_T	$T_{vj} = 25$ °C; $I_T = 1700$ A	max. 1,5	V
$V_{T(TO)}$	$T_{vj} = 130$ °C	max. 0,925	V
r_T	$T_{vj} = 130$ °C	max. 0,27	mΩ
I_{DD}, I_{RD}	$T_{vj} = 130$ °C; $V_{RD} = V_{RRM}, V_{DD} = V_{DRM}$	max. 100	mA
t_{gd}	$T_{vj} = 25$ °C; $I_G = 1$ A; $di_G/dt = 1$ A/μs	1	μs
t_{gr}	$V_D = 0,67 * V_{DRM}$	2	μs
$(di/dt)_{cr}$	$T_{vj} = 130$ °C	max. 200	A/μs
$(dv/dt)_{cr}$	$T_{vj} = 130$ °C	max. 1000	V/μs
t_q	$T_{vj} = 130$ °C	100 ... 200	μs
I_H	$T_{vj} = 25$ °C; typ. / max.	150 / 500	mA
I_L	$T_{vj} = 25$ °C; $R_G = 33$ Ω; typ. / max.	300 / 2000	mA
V_{GT}	$T_{vj} = 25$ °C; d.c.	min. 3	V
I_{GT}	$T_{vj} = 25$ °C; d.c.	min. 200	mA
V_{GD}	$T_{vj} = 130$ °C; d.c.	max. 0,25	V
I_{GD}	$T_{vj} = 130$ °C; d.c.	max. 10	mA
$R_{th(j-c)}$	cont.; per thyristor / per module	0,062 / 0,031	K/W
$R_{th(j-c)}$	sin. 180; per thyristor / per module	0,065 / 0,032	K/W
$R_{th(j-c)}$	rec. 120; per thyristor / per module	0,07 / 0,035	K/W
$R_{th(c-s)}$	per thyristor / per module	0,02 / 0,01	K/W
T_{vj}		- 40 ... + 130	°C
T_{stg}		- 40 ... + 130	°C
V_{isol}	a. c. 50 Hz; r.m.s.; 1 s / 1 min.	3600 / 3000	V~
M_s	to heatsink	5 ± 15 % ¹⁾	Nm
M_t	to terminals	12 ± 15 % ²⁾	Nm
a		5 * 9,81	m/s ²
m	approx.	1420	g
Case	SKKT	A 60 a	
	SKKH	A 66 a	

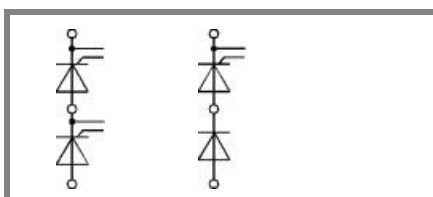

SKKT

SKKH

SKKT 500, SKKH 500

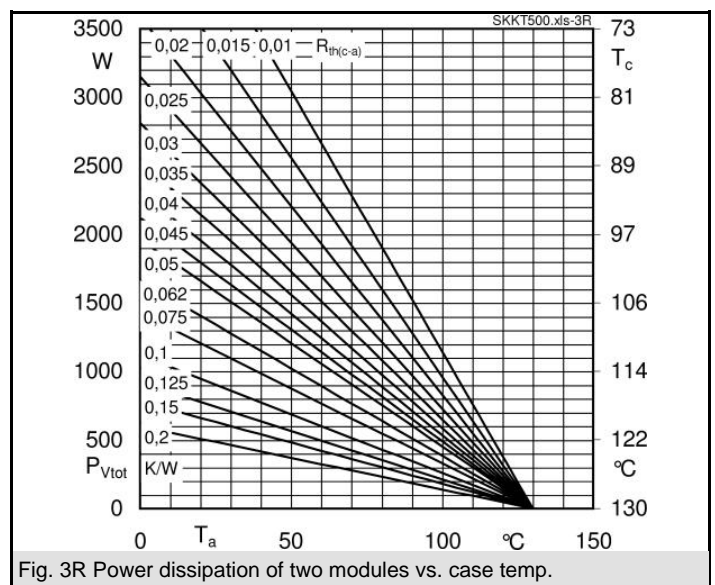
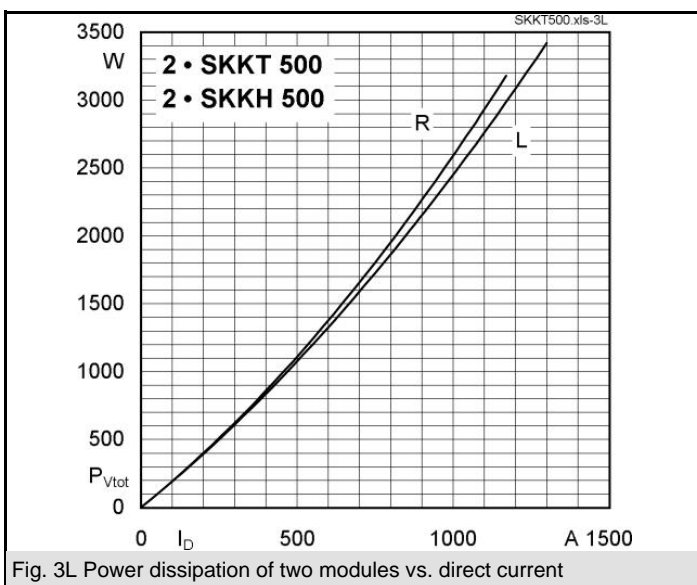
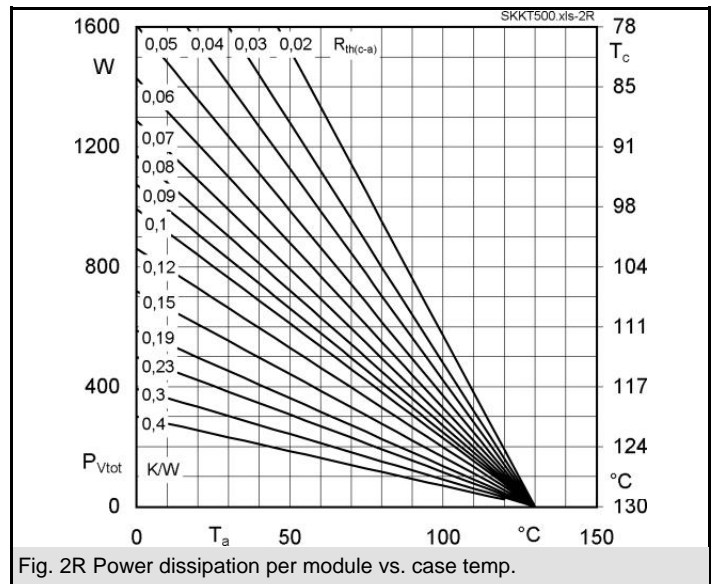
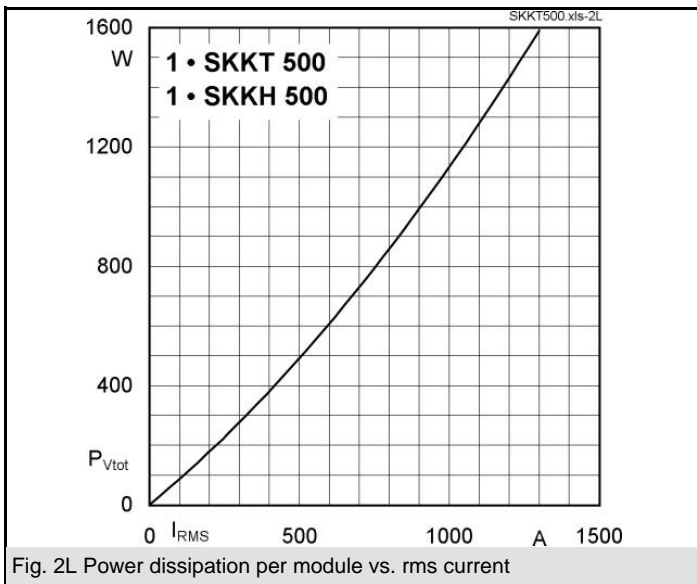
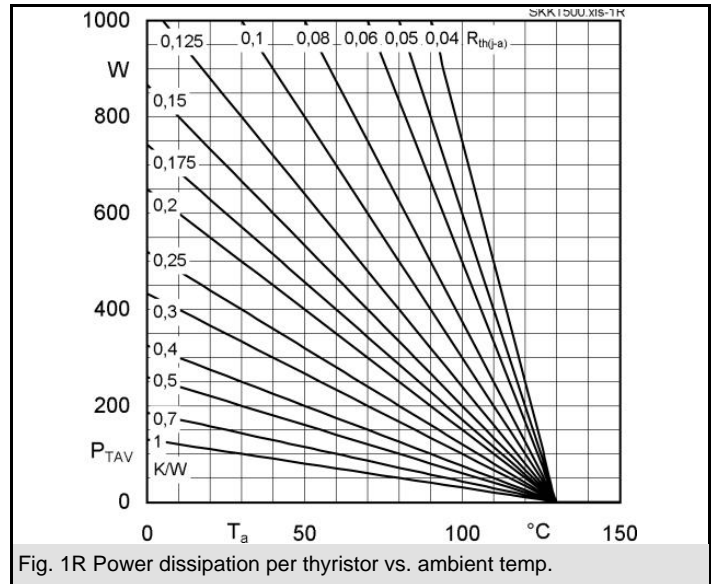
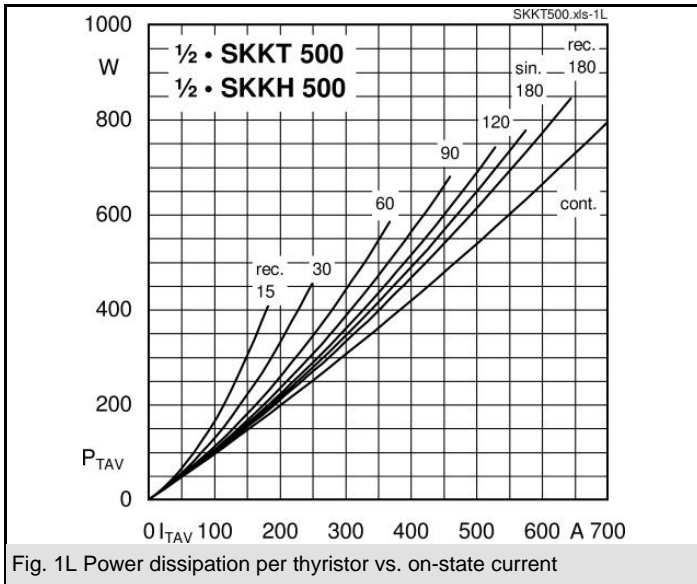

SKKT 500, SKKH 500

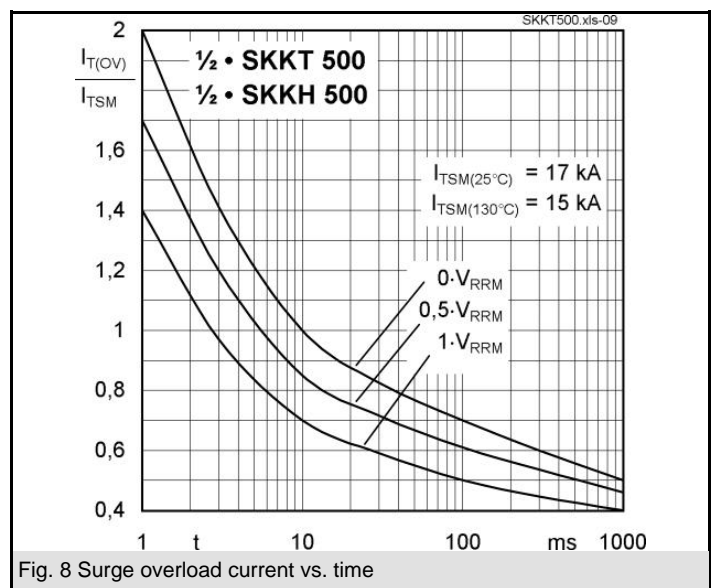
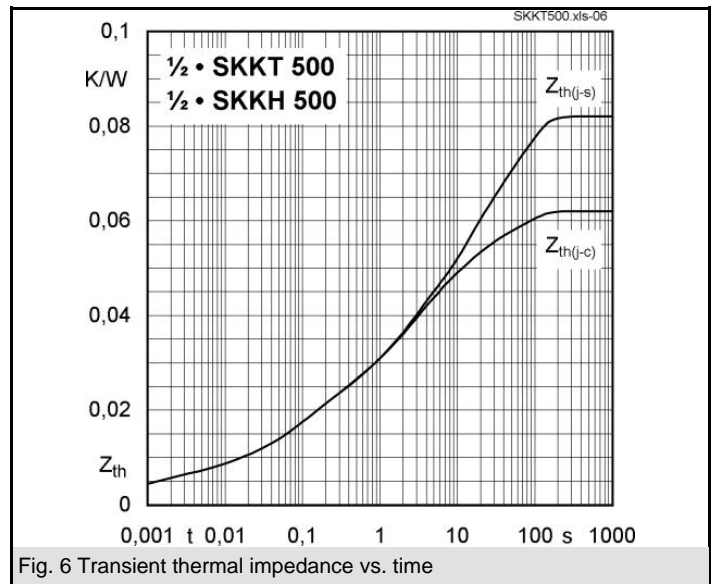
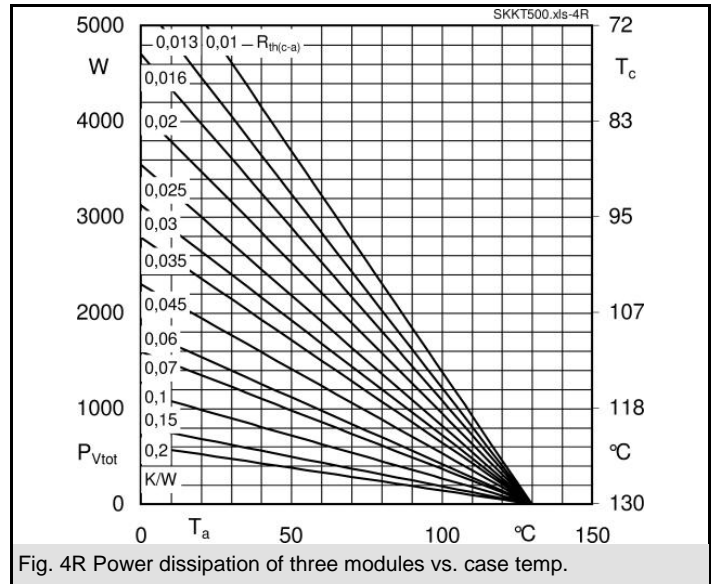
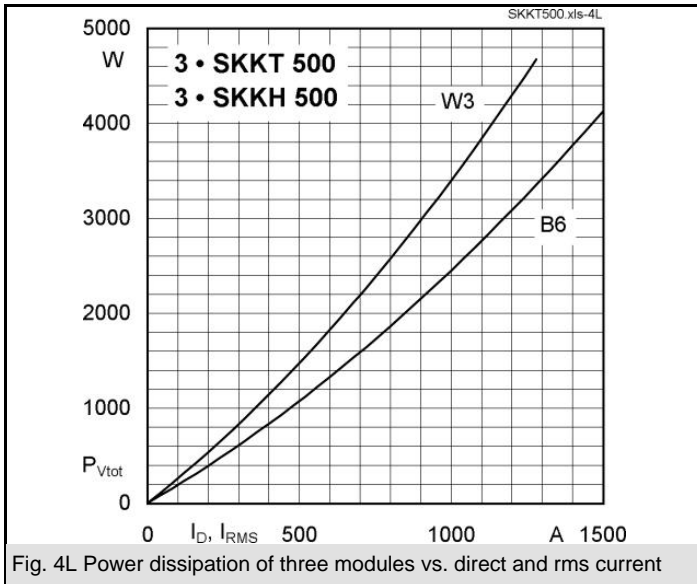

SKKT 500, SKKH 500

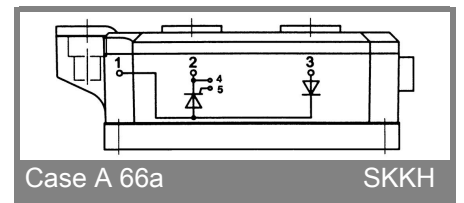
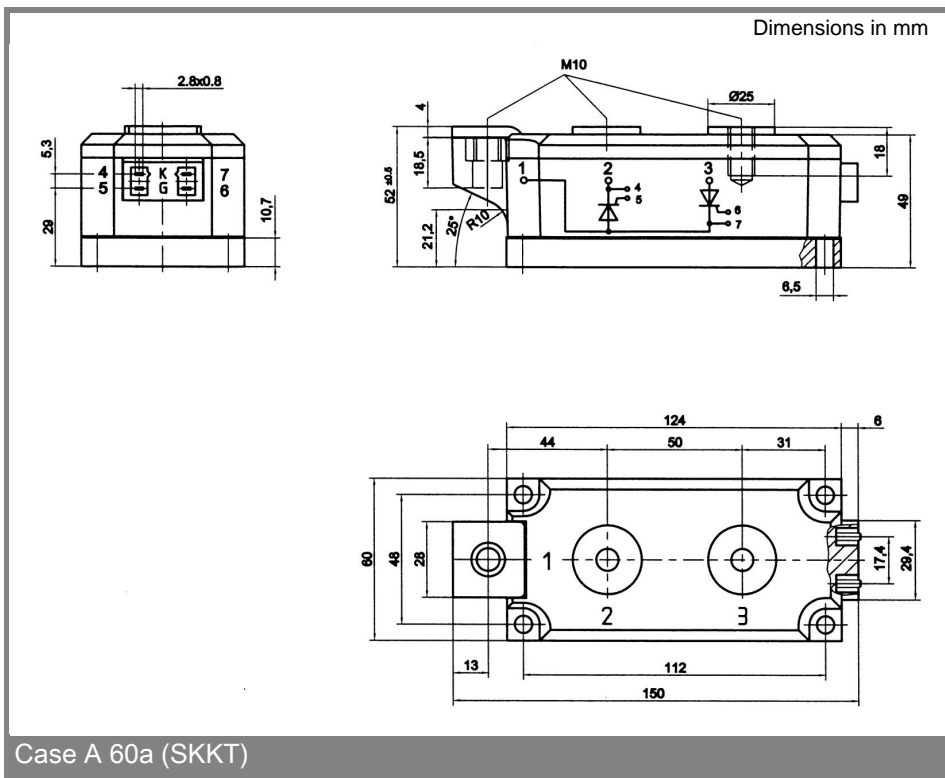
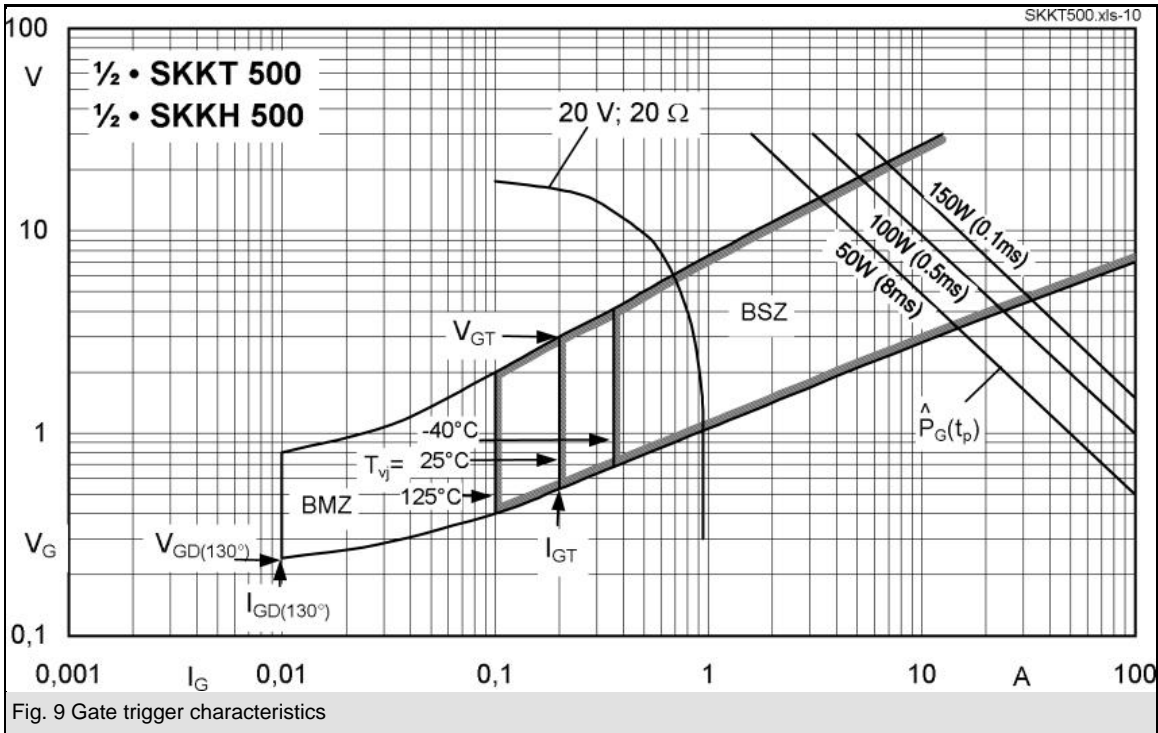

This technical information specifies semiconductor devices but promises no characteristics. No warranty or guarantee expressed or implied is made regarding delivery, performance or suitability.