



SKiM[®] 4

SPT IGBT Modules

SKiM 200GD128D

Preliminary Data

Features

- N channel, homogenous planar IGBT Silicon structure with n+ buffer layer in SPT (soft punch through) technology
- Low inductance case
- Fast & soft inverse CAL diodes
- Isolated by Al₂O₃ DCB (Direct Copper Bonded) ceramic plate
- Pressure contact technology for thermal contacts
- Spring contact system to attach driver PCB to the control terminals
- Integrated temperature sensor

Typical Applications

- Switched mode power supplies
- Three phase inverters for AC motor speed control
- Switching (not for linear use)

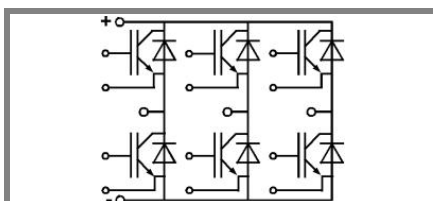

GD

Absolute Maximum Ratings		$T_c = 25\text{ °C}$, unless otherwise specified	
Symbol	Conditions	Values	Units
IGBT			
V_{CES}		1200	V
I_C	$T_s = 25\text{ (70) °C}$	180 (135)	A
I_{CRM}	$t_p = 1\text{ ms}$	300	A
V_{GES}		± 20	V
T_j (T_{stg})		- 40 ... + 150 (125)	°C
T_{cop}	max. case operating temperature	125	°C
V_{isol}	AC, 1 min.	2500	V
Inverse diode			
I_F	$T_s = 25\text{ (70) °C}$	150 (100)	A
I_{FRM}	$t_p = 1\text{ ms}$	300	A
I_{FSM}	$t_p = 10\text{ ms}$; sin.; $T_j = 150\text{ °C}$	1400	A

Characteristics		$T_c = 25\text{ °C}$, unless otherwise specified			
Symbol	Conditions	min.	typ.	max.	Units
IGBT					
$V_{GE(th)}$	$V_{GE} = V_{CE}$; $I_C = 6\text{ mA}$	4,45	5,5	6,55	V
I_{CES}	$V_{GE} = 0$; $V_{CE} = V_{CES}$; $T_j = 25\text{ °C}$		0,1	0,3	mA
V_{CEO}	$T_j = 25\text{ (125) °C}$		1 (0,9)	1,15 (1,05)	V
r_{CE}	$T_j = 25\text{ (125) °C}$		6 (8)	8 (10)	mΩ
V_{CEsat}	$I_{Cnom} = 150\text{ A}$; $V_{GE} = 15\text{ V}$; $T_j = 25\text{ (125) °C}$ on chip level		1,9 (2,1)	2,35 (2,55)	V
C_{ies}	$V_{GE} = 0$; $V_{CE} = 25\text{ V}$; $f = 1\text{ MHz}$		11		nF
C_{oes}	$V_{GE} = 0$; $V_{CE} = 25\text{ V}$; $f = 1\text{ MHz}$		1		nF
C_{res}	$V_{GE} = 0$; $V_{CE} = 25\text{ V}$; $f = 1\text{ MHz}$		0,7		nF
L_{CE}				15	nH
$R_{CC'+EE'}$	resistance, terminal-chip $T_c = 25\text{ (125) °C}$		1,35 (1,75)		mΩ
$t_{d(on)}$	$V_{CC} = 600\text{ V}$		200		ns
t_r	$I_{Cnom} = 150\text{ A}$		45		ns
$t_{d(off)}$	$R_{Gon} = R_{Goff} = 3,6\text{ Ω}$		450		ns
t_f	$T_j = 125\text{ °C}$		55		ns
$E_{on} (E_{off})$	$V_{GE} \pm 15\text{ V}$		16,6 (14,7)		mJ
$E_{on} (E_{off})$	with SKHI 64; $T_j = 125\text{ °C}$ $V_{CC} = 600\text{ V}$; $I_C = 150\text{ A}$		15 (18,8)		mJ
Inverse diode					
$V_F = V_{EC}$	$I_{Fnom} = 150\text{ A}$; $V_{GE} = 0\text{ V}$; $T_j = 25\text{ (125) °C}$		2,3 (2,1)	2,65	V
V_{TO}	$T_j = 125\text{ °C}$		1,1		V
r_T	$T_j = 125\text{ °C}$		6		mΩ
I_{RRM}	$I_F = 150\text{ A}$; $T_j = 125\text{ °C}$		230		A
Q_{rr}	$V_{GE} = 0\text{ V}$ di/dt = 6300 A/μs		25		μC
E_{rr}	$R_{Gon} = R_{Goff} = 3,6\text{ Ω}$		9,9		mJ
Thermal characteristics					
$R_{th(j-s)}$	per IGBT			0,24	K/W
$R_{th(j-s)}$	per FWD			0,37	K/W
Temperature Sensor					
R_{TS}	$T = 25\text{ (100) °C}$		1 (1,67)		kΩ
tolerance	$T = 25\text{ (100) °C}$		3 (2)		%
Mechanical data					
M_1	to heatsink (M5)	2		3	Nm
M_2	for terminals (M6)	4		5	Nm
w				310	g

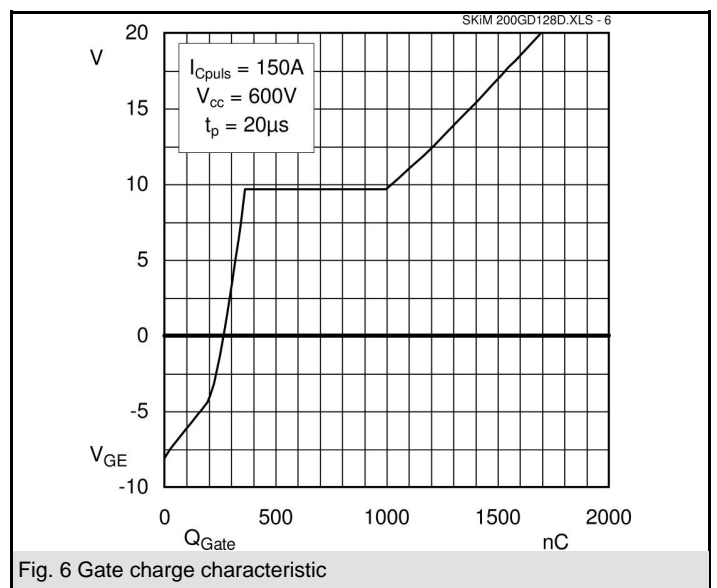
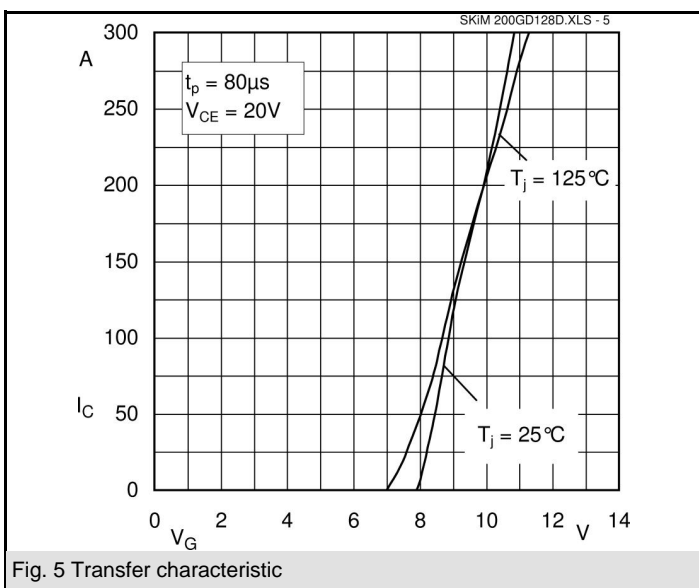
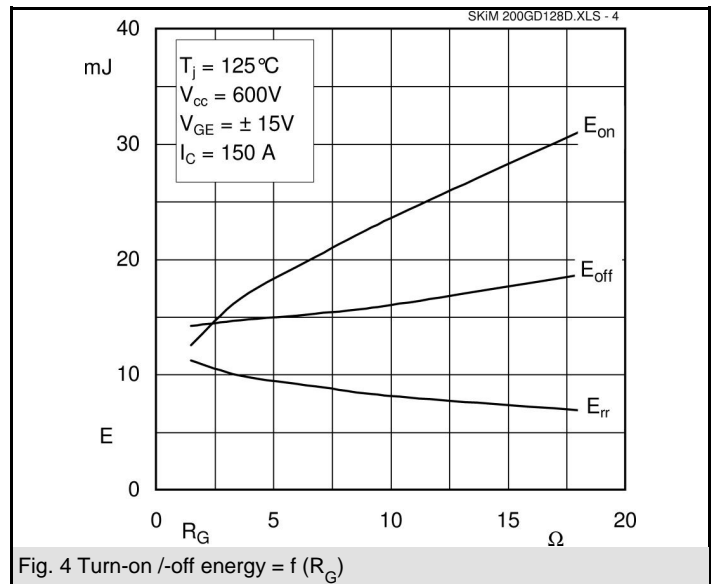
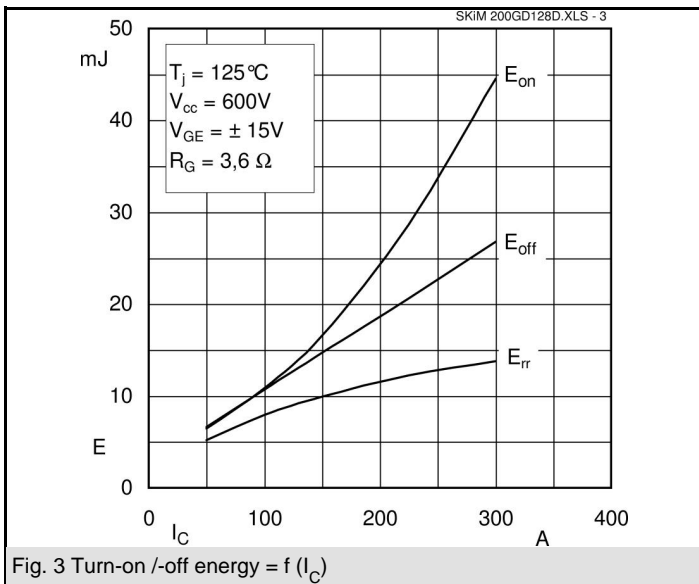
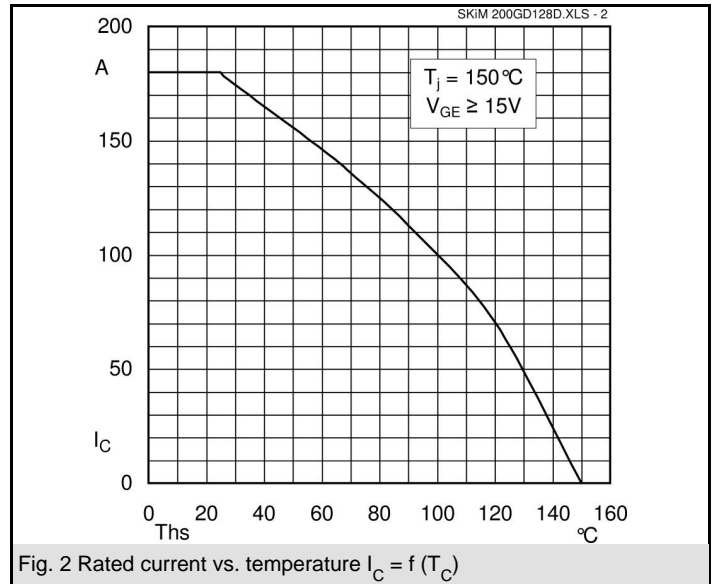
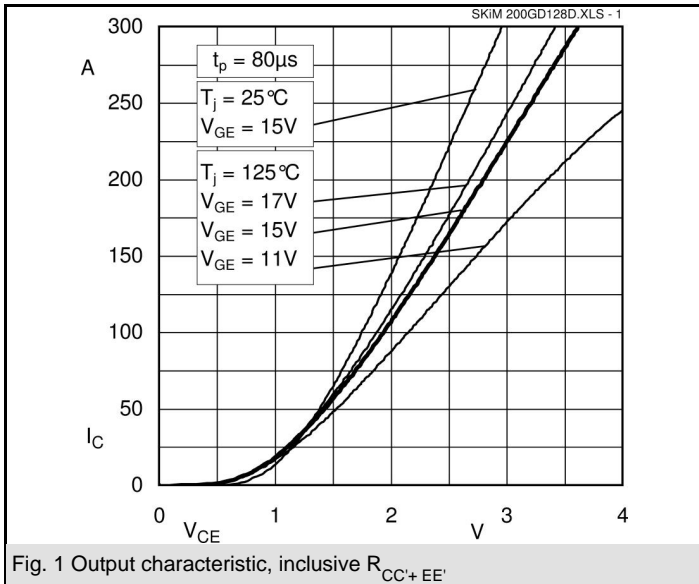

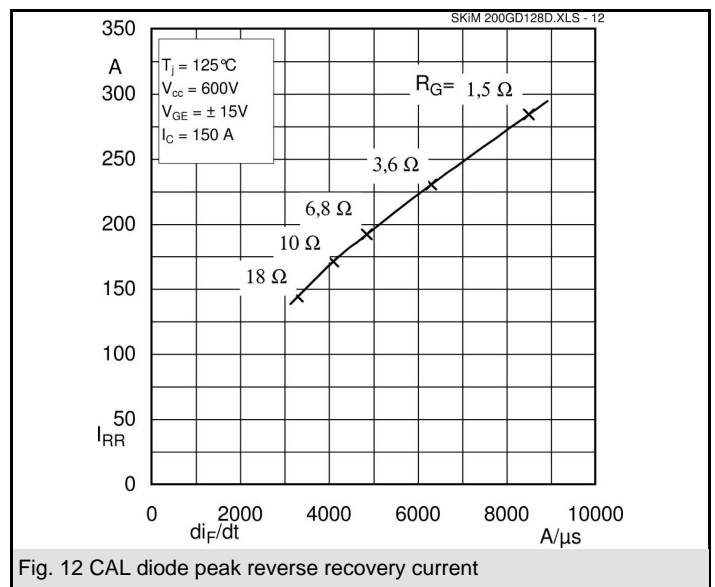
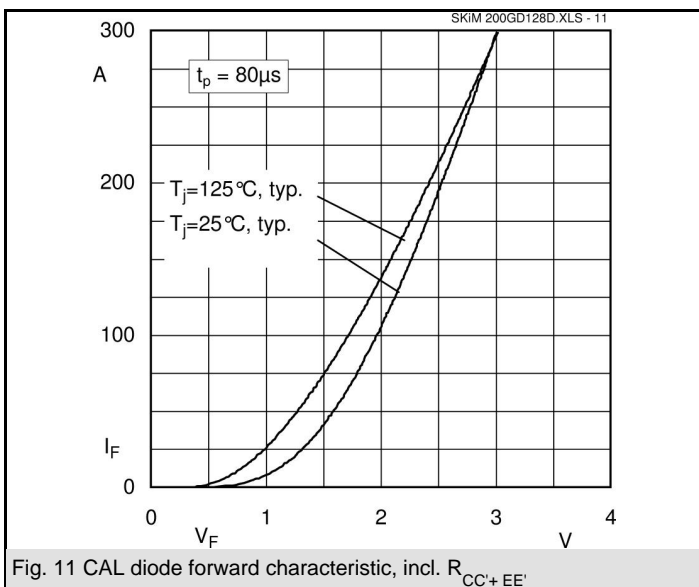
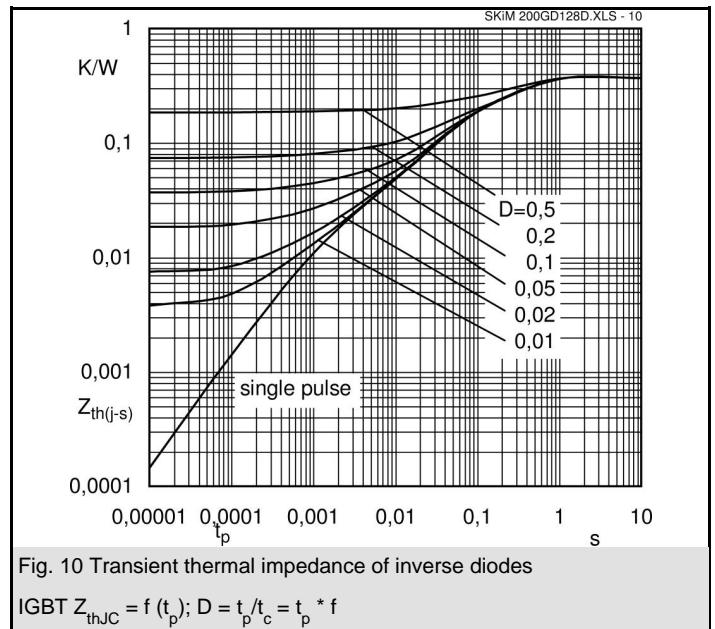
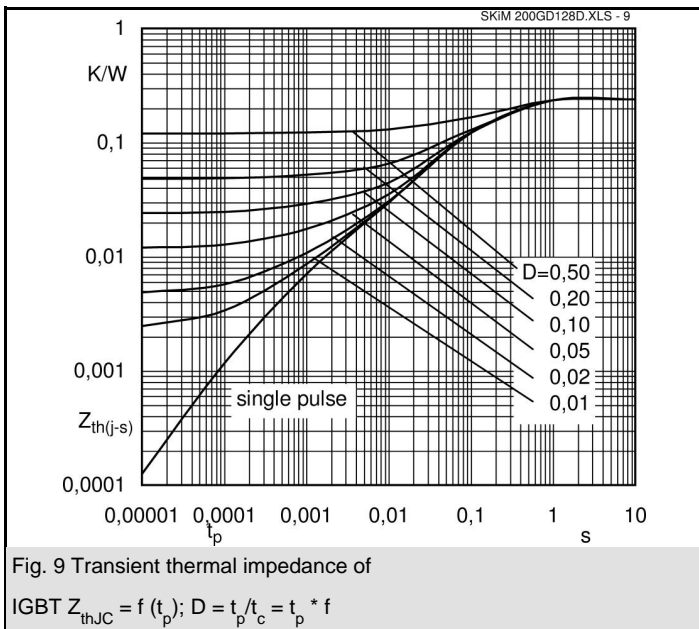
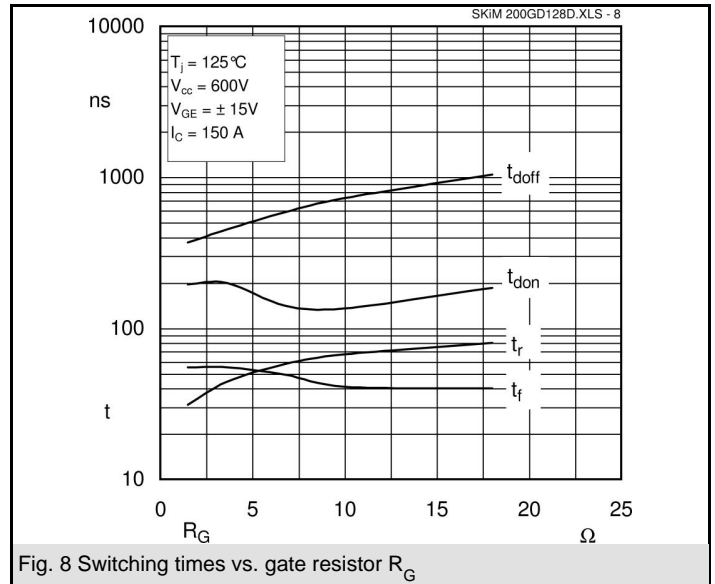
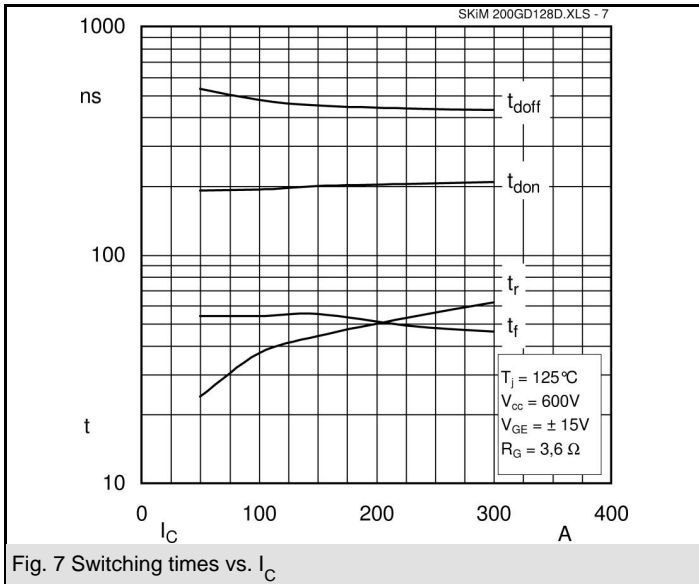

SKiM 200GD128D

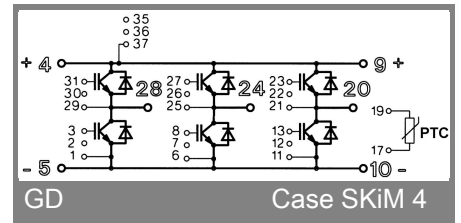
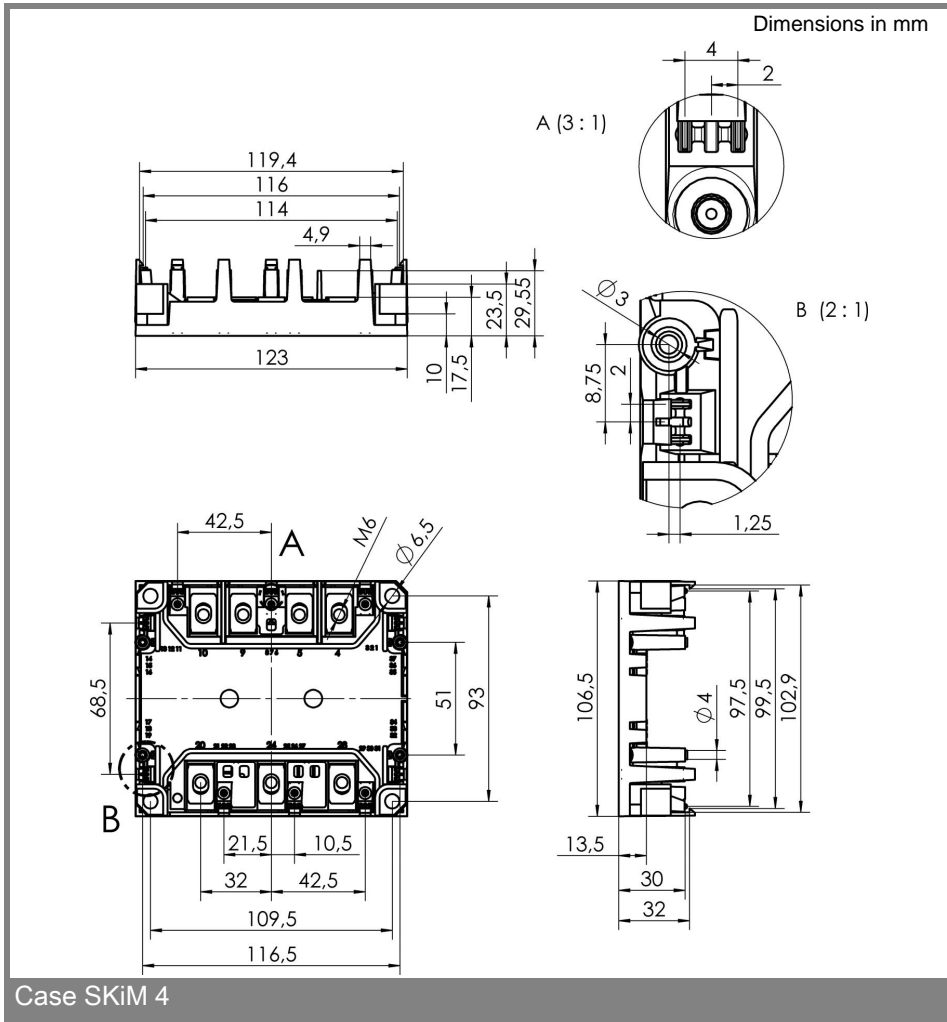
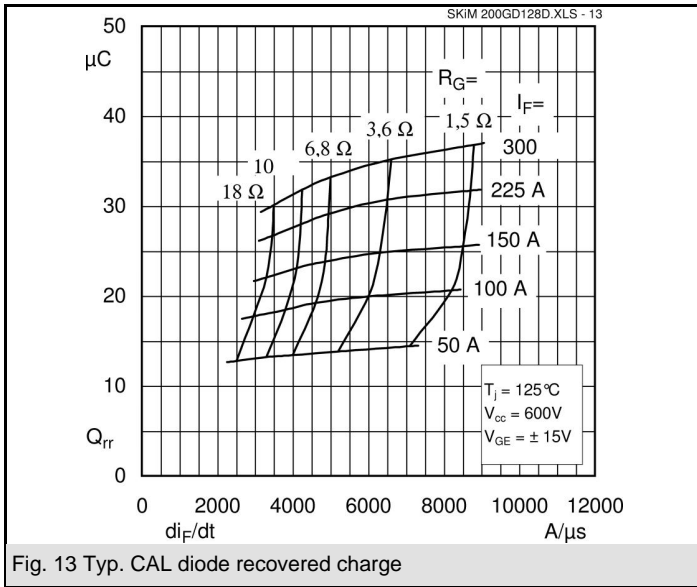

This is an electrostatic discharge sensitive device (ESDS), international standard IEC 60747-1, Chapter IX.

This technical information specifies semiconductor devices but promises no characteristics. No warranty or guarantee expressed or implied is made regarding delivery, performance or suitability.