

# SKiiP 28AC065V1



MiniSKiiP<sup>®</sup> 2

## 3-phase bridge inverter

### SKiiP 28AC065V1

#### Features

- Ultrafast NPT IGBTs
- Robust and soft freewheeling diodes in CAL technology
- Highly reliable spring contacts for electrical connections
- UL recognised file no. E63532

#### Typical Applications

- Inverter up to 22 kVA
- Typical motor power 11 kW

#### Remarks

- $V_{CEsat}$ ,  $V_F$  = chip level value

Absolute Maximum Ratings		$T_s = 25\text{ °C}$ , unless otherwise specified	
Symbol	Conditions	Values	Units
<b>IGBT - Inverter</b>			
$V_{CES}$	$T_s = 25\text{ (70) °C}$ $t_p \leq 1\text{ ms}$	600	V
$I_C$		94 (70)	A
$I_{CRM}$		200	A
$V_{GES}$		$\pm 20$	V
$T_j$		- 40 ... + 150	°C
<b>Diode - Inverter</b>			
$I_F$	$T_s = 25\text{ (70) °C}$ $t_p \leq 1\text{ ms}$	96 (71)	A
$I_{FRM}$		200	A
$T_j$		- 40 ... + 150	°C
$I_{tRMS}$	per power terminal (20 A / spring)	100	A
$T_{stg}$	$T_{op} \leq T_{stg}$	- 40 ... + 150	°C
$V_{isol}$	AC, 1 min.	2500	V

Characteristics		$T_s = 25\text{ °C}$ , unless otherwise specified			
Symbol	Conditions	min.	typ.	max.	Units
<b>IGBT - Inverter</b>					
$V_{CEsat}$	$I_{Cnom} = 100\text{ A}$ , $T_j = 25\text{ (125) °C}$		2 (2,2)	2,5 (2,7)	V
$V_{GE(th)}$	$V_{GE} = V_{CE}$ , $I_C = 2\text{ mA}$	3	4	5	V
$V_{CE(TO)}$	$T_j = 25\text{ (125) °C}$		1,2 (1,1)	1,3 (1,2)	V
$r_T$	$T_j = 25\text{ (125) °C}$		8 (11)	12 (15)	mΩ
$C_{ies}$	$V_{CE} = 25\text{ V}$ , $V_{GE} = 0\text{ V}$ , $f = 1\text{ MHz}$		5,4		nF
$C_{oes}$	$V_{CE} = 25\text{ V}$ , $V_{GE} = 0\text{ V}$ , $f = 1\text{ MHz}$		1,1		nF
$C_{res}$	$V_{CE} = 25\text{ V}$ , $V_{GE} = 0\text{ V}$ , $f = 1\text{ MHz}$		1,3		nF
$R_{th(j-s)}$	per IGBT		0,5		K/W
$t_{d(on)}$	under following conditions		45		ns
$t_r$	$V_{CC} = 300\text{ V}$ , $V_{GE} = \pm 15\text{ V}$		50		ns
$t_{d(off)}$	$I_{Cnom} = 100\text{ A}$ , $T_j = 125\text{ °C}$		335		ns
$t_f$	$R_{Gon} = R_{Goff} = 12\text{ Ω}$		40		ns
$E_{on}$	inductive load		2,1		mJ
$E_{off}$			2,6		mJ
<b>Diode - Inverter</b>					
$V_F = V_{EC}$	$I_{Fnom} = 100\text{ A}$ , $T_j = 25\text{ (125) °C}$		1,6 (1,6)	1,9 (1,9)	V
$V_{(TO)}$	$T_j = 25\text{ (125) °C}$		1 (0,9)	1,1 (1)	V
$r_T$	$T_j = 25\text{ (125) °C}$		6 (7)	8 (9)	mΩ
$R_{th(j-s)}$	per diode		0,7		K/W
$I_{RRM}$	under following conditions		92		A
$Q_{rr}$	$I_{Fnom} = 100\text{ A}$ , $V_R = 300\text{ V}$		9,1		μC
$E_{rr}$	$V_{GE} = 0\text{ V}$ , $T_j = 125\text{ °C}$ $di_F/dt = 2350\text{ A/μs}$		1,9		mJ
<b>Temperature Sensor</b>					
$R_{ts}$	3 %, $T_r = 25\text{ (100) °C}$		1000(1670)		Ω
<b>Mechanical Data</b>					
m			65		g
$M_s$	Mounting torque	2		2,5	Nm

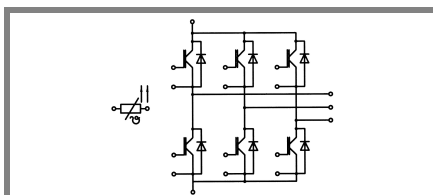

AC

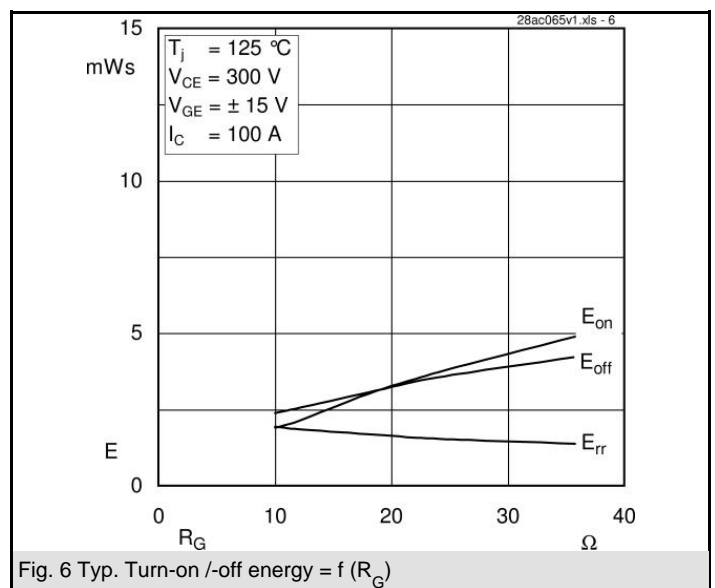
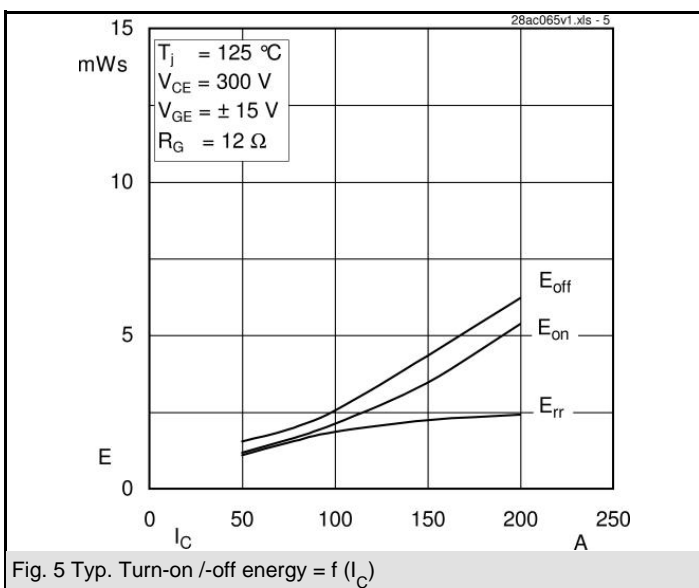
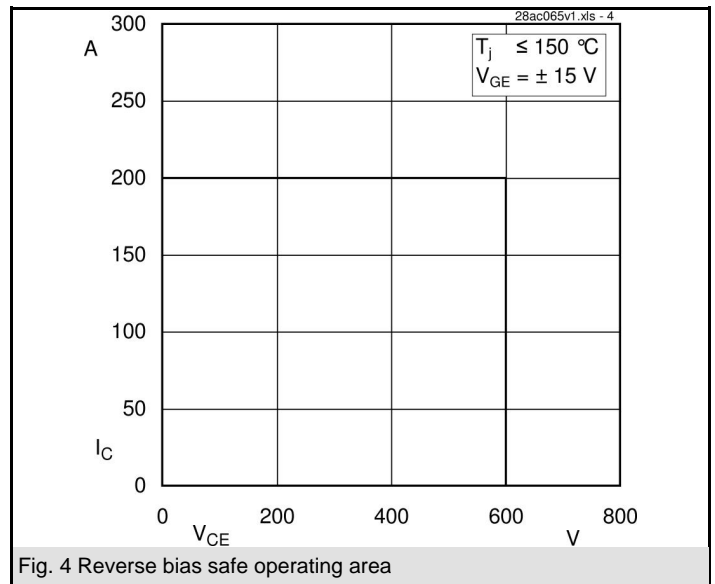
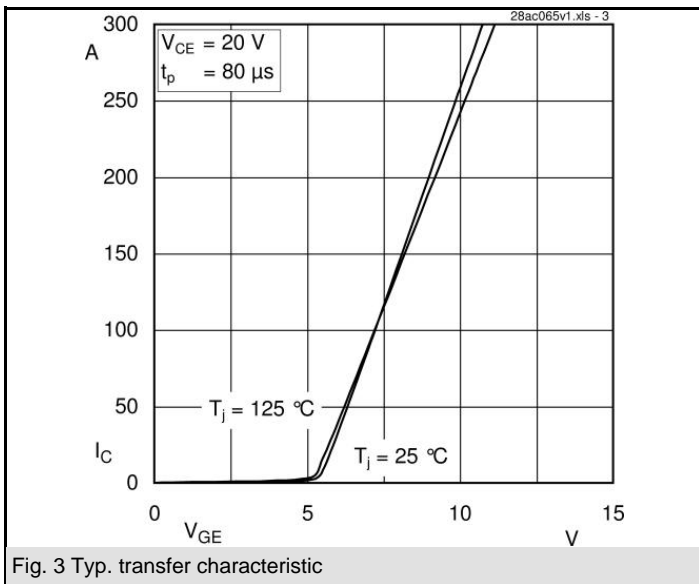
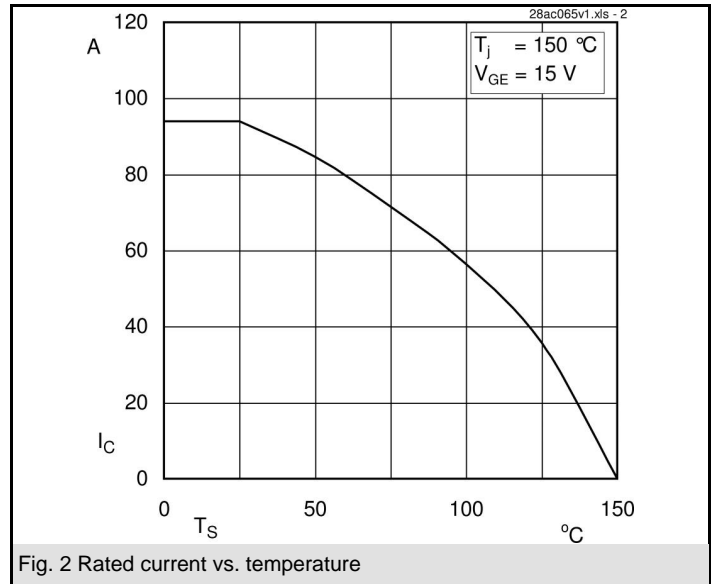
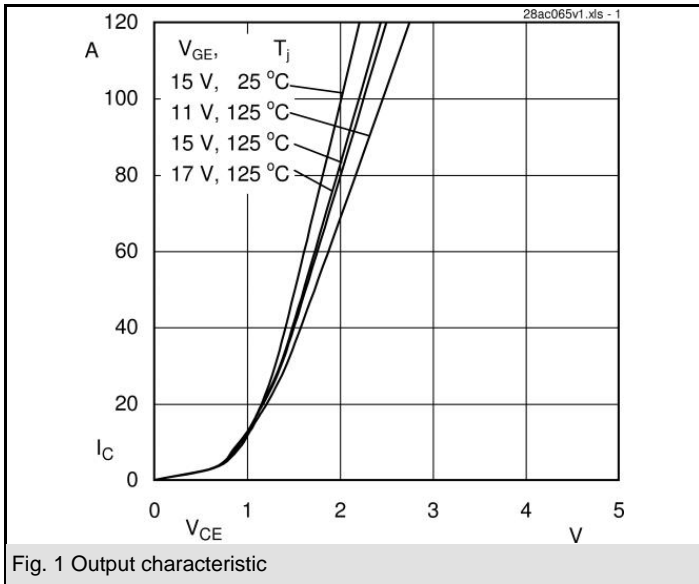

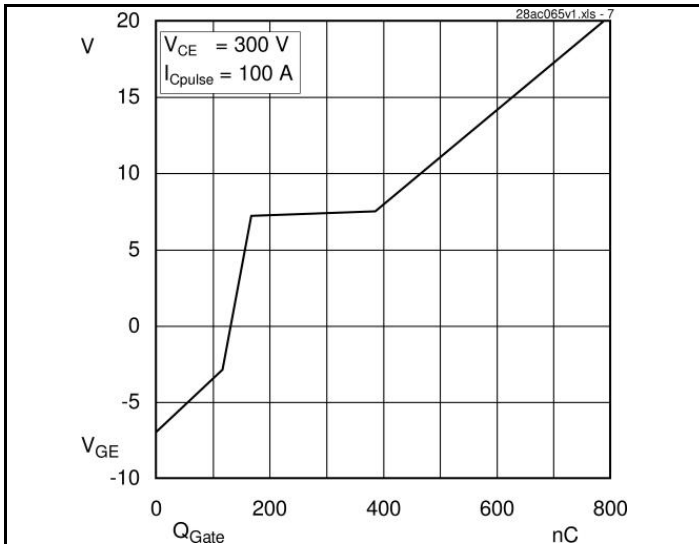

Fig. 7 Typ. gate charge characteristic

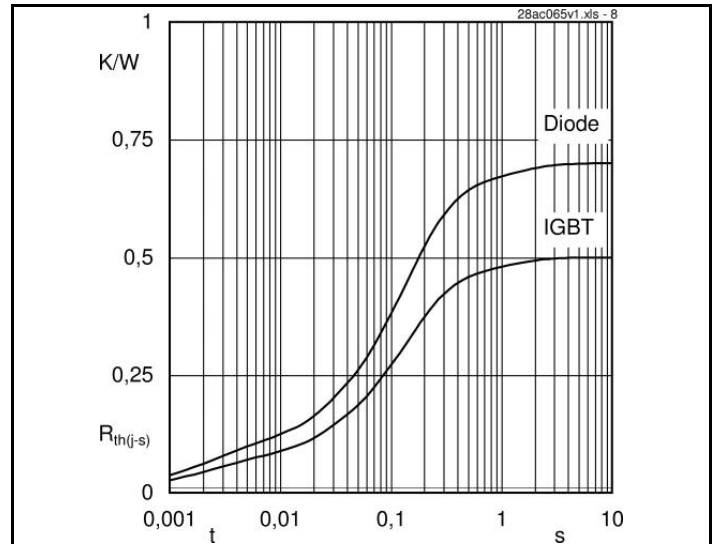

Fig. 8 Typ. thermal impedance

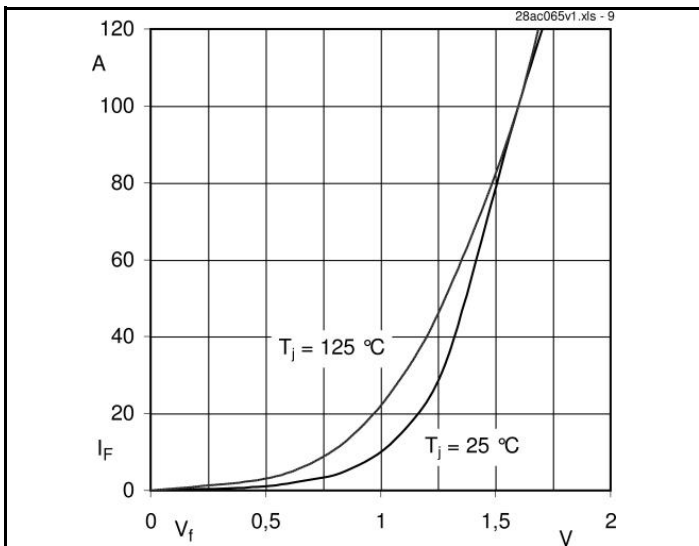
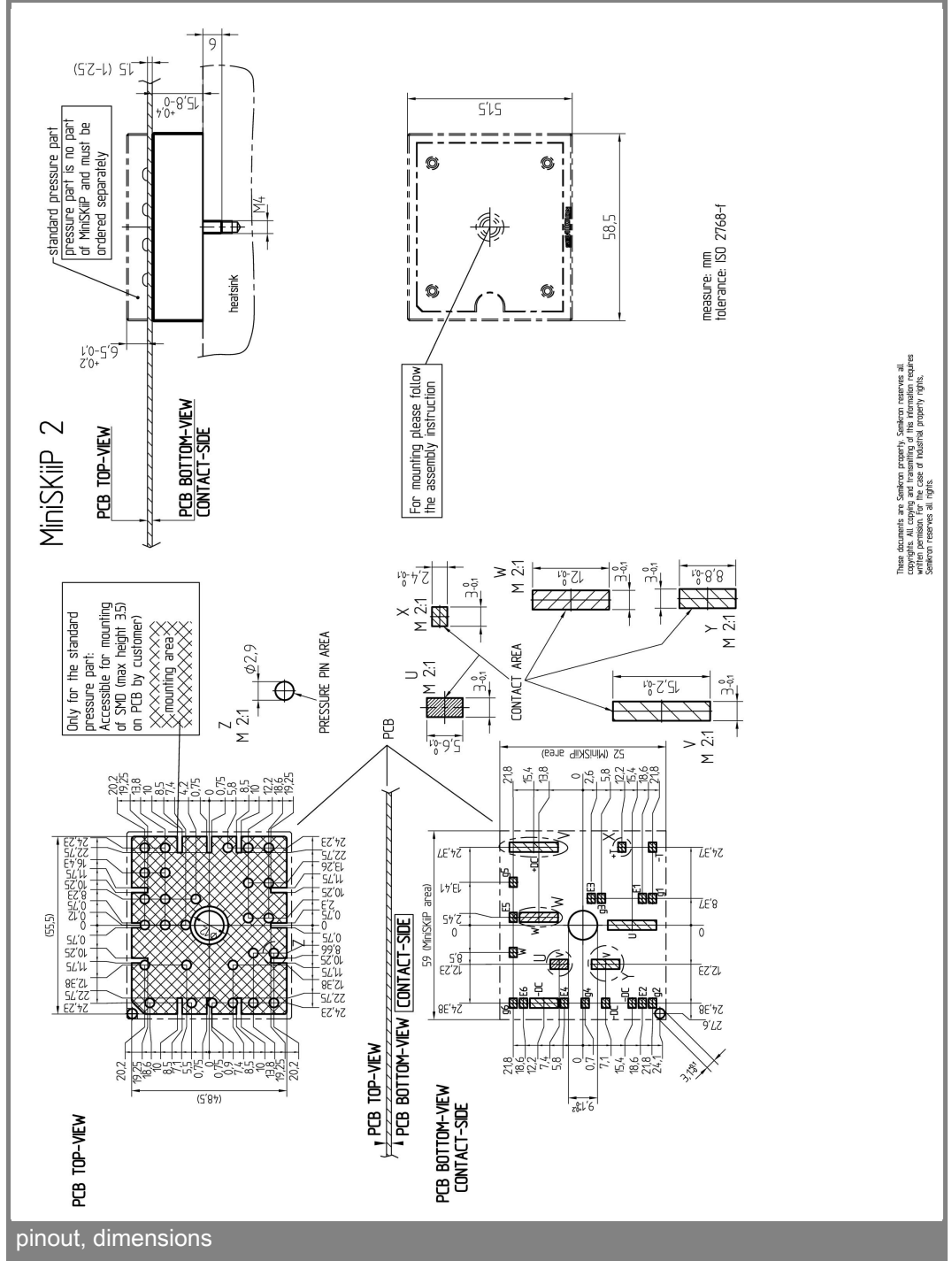
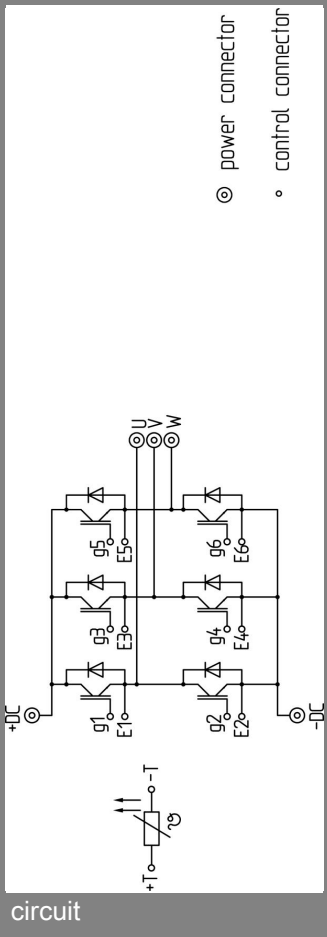

Fig. 9 Typ. freewheeling diode forward characteristic



These documents are Semikron property. Semikron reserves all copyrights. All copies and transmitting of the information requires written permission. In the case of industrial property rights, Semikron reserves all rights.

This is an electrostatic discharge sensitive device (ESDS), international standard IEC 60747-1, Chapter IX.

This technical information specifies semiconductor devices but promises no characteristics. No warranty or guarantee expressed or implied is made regarding delivery, performance or suitability.