

QM20TD-H

MEDIUM POWER SWITCHING USE
INSULATED TYPE

QM20TD-H



- **IC** Collector current **20A**
- **VCEX** Collector-emitter voltage **600V**
- **hFE** DC current gain **75**
- **Insulated Type**
- **UL Recognized**

Yellow Card No. E80276 (N)
File No. E80271

APPLICATION

Air conditioner, Small to medium size inverters, CVCF

OUTLINE DRAWING & CIRCUIT DIAGRAM

Dimensions in mm

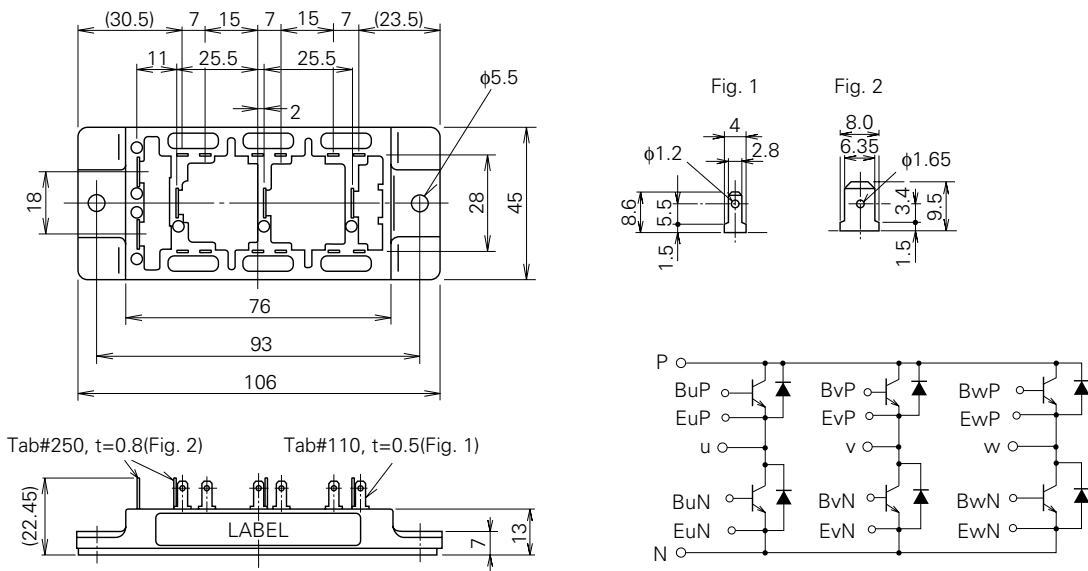

Note: All Transistor Units are Darlington.

QM20TD-H

MEDIUM POWER SWITCHING USE
INSULATED TYPE

ABSOLUTE MAXIMUM RATINGS (T_j=25°C, unless otherwise noted)

Symbol	Parameter	Conditions	Ratings	Unit
VCEX (SUS)	Collector-emitter voltage	I _C =1A, V _{EB} =2V	600	V
VCEX	Collector-emitter voltage	V _{EB} =2V	600	V
VCBO	Collector-base voltage	Emitter open	600	V
VEBO	Emitter-base voltage	Collector open	7	V
I _C	Collector current	DC	20	A
-I _C	Collector reverse current	DC (forward diode current)	20	A
P _C	Collector dissipation	T _C =25°C	100	W
I _B	Base current	DC	1	A
-I _{CSM}	Surge collector reverse current (forward diode current)	Peak value of one cycle of 60Hz (half wave)	200	A
T _j	Junction temperature		-40~+150	°C
T _{stg}	Storage temperature		-40~+125	°C
V _{iso}	Isolation voltage	Charged part to case, AC for 1 minute	2000	V
—	Mounting torque	Mounting screw M5	1.47~1.96	N·m
—	Weight	Typical value	15~20	kg·cm
—	Weight	Typical value	90	g

ELECTRICAL CHARACTERISTICS (T_j=25°C, unless otherwise noted)

Symbol	Parameter	Test conditions	Limits			Unit
			Min.	Typ.	Max.	
I _C EX	Collector cutoff current	V _{CE} =600V, V _{EB} =2V	—	—	1.0	mA
I _C BO	Collector cutoff current	V _{CB} =600V, Emitter open	—	—	1.0	mA
I _E BO	Emitter cutoff current	V _{EB} =7V	—	—	150	mA
V _{CE} (sat)	Collector-emitter saturation voltage	I _C =20A, I _B =0.28A	—	—	2.0	V
V _{BE} (sat)	Base-emitter saturation voltage		—	—	2.5	V
-V _{CEO}	Collector-emitter reverse voltage	-I _C =20A (diode forward voltage)	—	—	1.5	V
h _{FE}	DC current gain	I _C =20A, V _{CE} =2V/5V	75/100	—	—	—
t _{on}	Switching time	V _{CC} =300V, I _C =20A, I _{B1} =-I _{B2} =0.4A	—	—	1.5	μs
t _s			—	—	12	μs
t _f			—	—	2.0	μs
R _{th} (j-c) Q	Thermal resistance (junction to case)	Transistor part (per 1/6 module)	—	—	1.2	°C/W
R _{th} (j-c) R		Diode part (per 1/6 module)	—	—	2.2	°C/W
R _{th} (c-f)	Contact thermal resistance (case to fin)	Conductive grease applied (per 1/6 module)	—	—	0.35	°C/W

QM20TD-H

MEDIUM POWER SWITCHING USE
INSULATED TYPE

PERFORMANCE CURVES

COMMON EMITTER OUTPUT CHARACTERISTICS (TYPICAL)

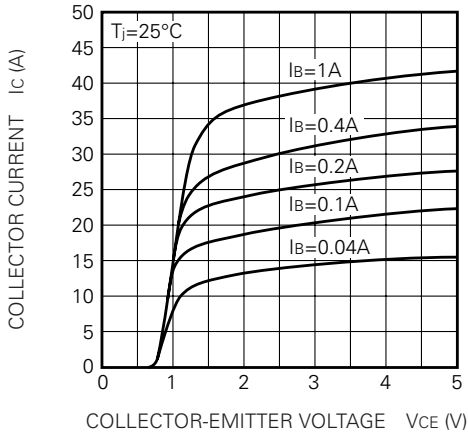

DC CURRENT GAIN VS. COLLECTOR CURRENT (TYPICAL)

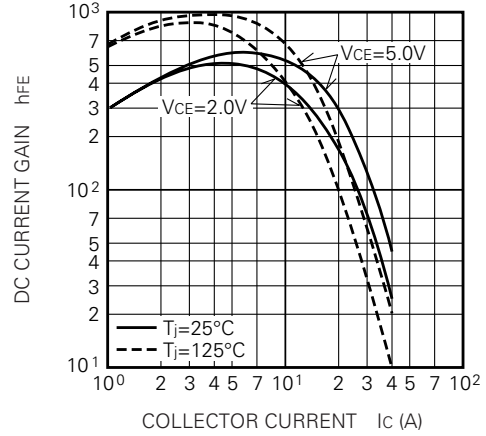

COMMON EMITTER INPUT CHARACTERISTIC (TYPICAL)

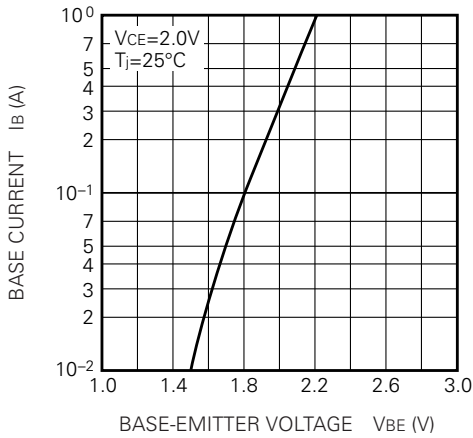

SATURATION VOLTAGE CHARACTERISTICS (TYPICAL)

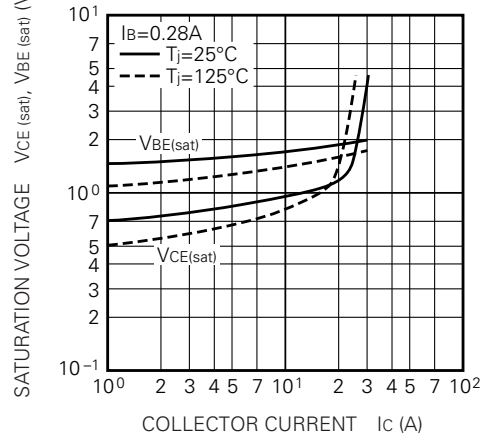

COLLECTOR-EMITTER SATURATION VOLTAGE (TYPICAL)

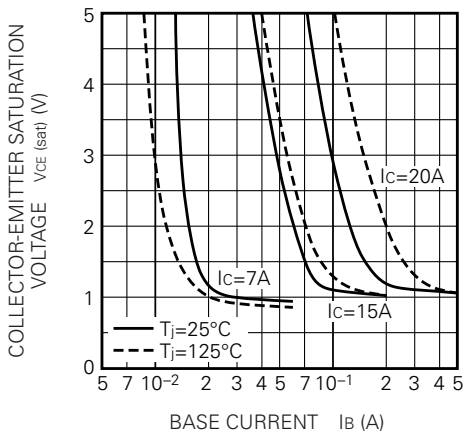

SWITCHING TIME VS. COLLECTOR CURRENT (TYPICAL)

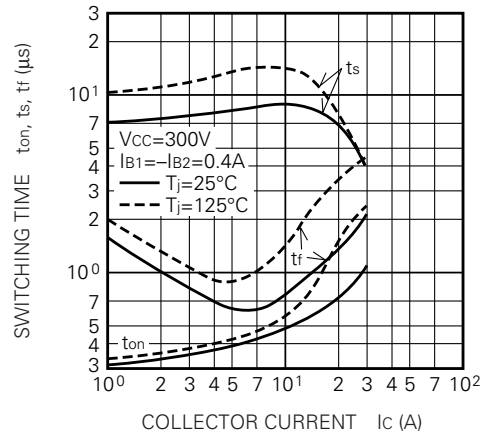

QM20TD-H

MEDIUM POWER SWITCHING USE
INSULATED TYPE

SWITCHING TIME VS. BASE CURRENT (TYPICAL)

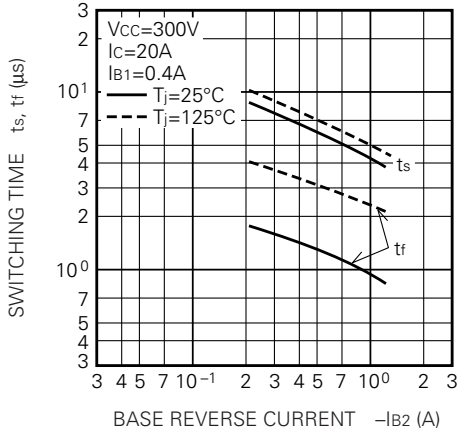

REVERSE BIAS SAFE OPERATING AREA

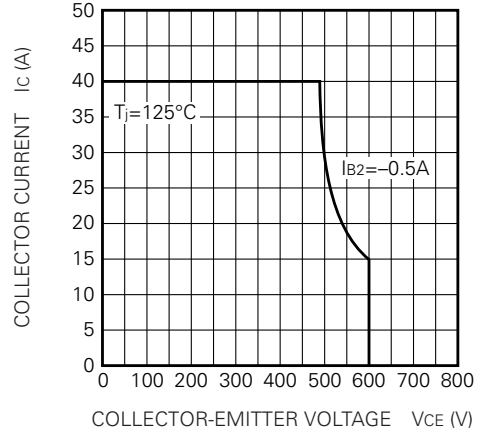

FORWARD BIAS SAFE OPERATING AREA

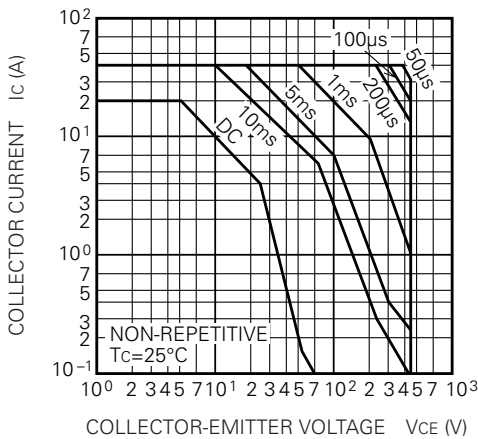

DERATING FACTOR OF F. B. S. O. A.

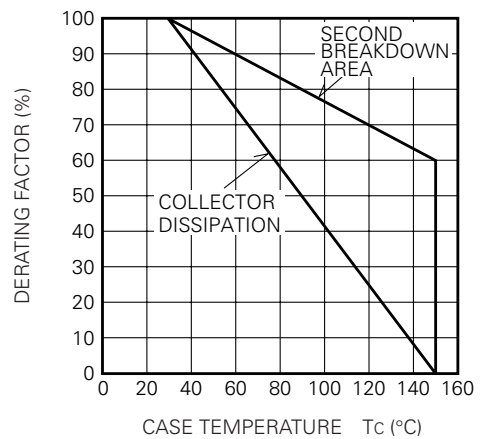

TRANSIENT THERMAL IMPEDANCE CHARACTERISTIC (TRANSISTOR)

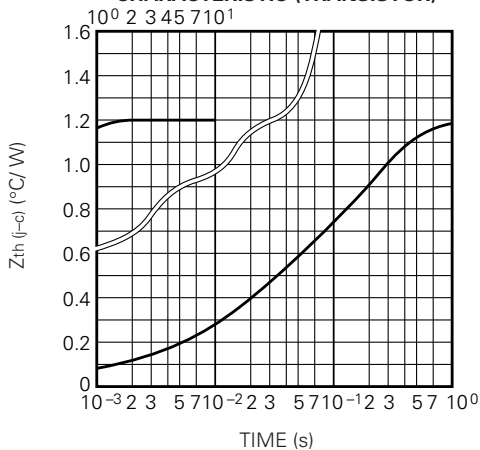

REVERSE COLLECTOR CURRENT VS. COLLECTOR-EMITTER REVERSE VOLTAGE (DIODE FORWARD CHARACTERISTICS) (TYPICAL)

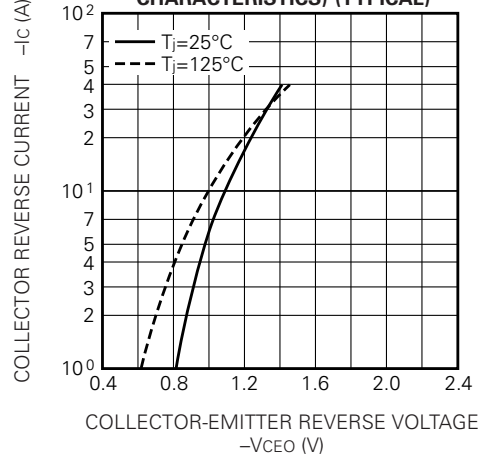

QM20TD-H

MEDIUM POWER SWITCHING USE
INSULATED TYPE

**RATED SURGE COLLECTOR REVERSE CURRENT
(DIODE FORWARD SURGE CURRENT)**

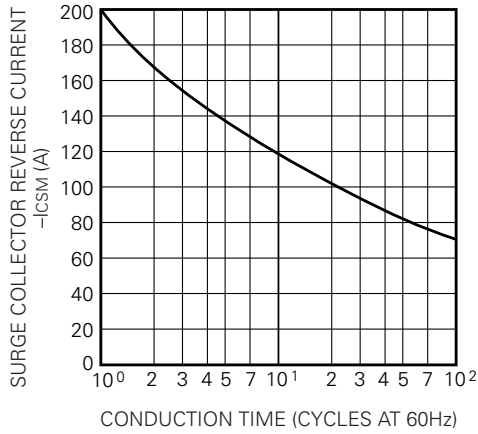

**REVERSE RECOVERY CHARACTERISTICS
OF FREE-WHEEL DIODE (TYPICAL)**

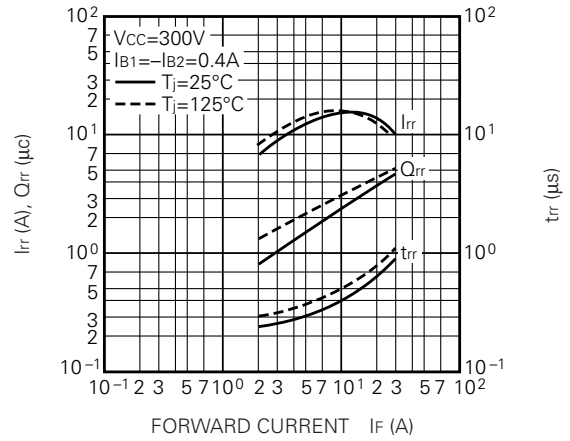

**TRANSIENT THERMAL IMPEDANCE
CHARACTERISTIC (DIODE)**

