

# QM20HA-HB

MEDIUM POWER SWITCHING USE  
INSULATED TYPE

## QM20HA-HB

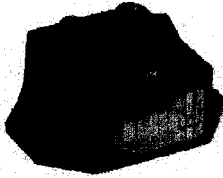

- **I<sub>C</sub>** Collector current ..... **20A**
- **V<sub>CEX</sub>** Collector-emitter voltage ..... **600V**
- **h<sub>FE</sub>** DC current gain ..... **250**
- **Insulated Type**
- **UL Recognized**

Yellow Card No. E80276 (N)  
File No. E80271

## APPLICATION

AC motor controllers, UPS, CVCF, DC motor controllers, NC equipment, Welders

## OUTLINE DRAWING & CIRCUIT DIAGRAM

Dimensions in mm

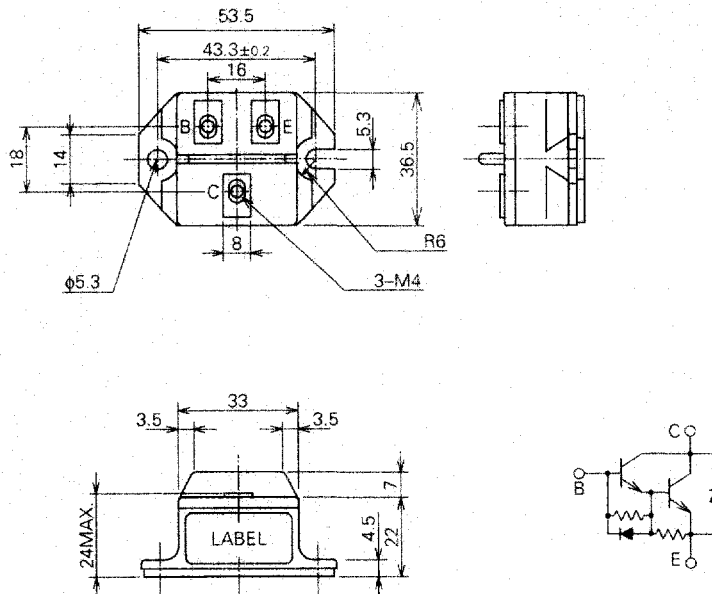

**QM20HA-HB**

**MEDIUM POWER SWITCHING USE  
INSULATED TYPE**

**ABSOLUTE MAXIMUM RATINGS** (T<sub>j</sub>=25°C, unless otherwise noted)

Symbol	Parameter	Conditions	Ratings	Unit
V <sub>CEX (SUS)</sub>	Collector-emitter voltage	I <sub>C</sub> =1A, V <sub>EB</sub> =2V	600	V
V <sub>CEX</sub>	Collector-emitter voltage	V <sub>EB</sub> =2V	600	V
V <sub>CB0</sub>	Collector-base voltage	Emitter open	600	V
V <sub>EB0</sub>	Emitter-base voltage	Collector open	7	V
I <sub>C</sub>	Collector current	DC	20	A
-I <sub>C</sub>	Collector reverse current	DC (forward diode current)	160	A
P <sub>C</sub>	Collector dissipation	T <sub>C</sub> =25°C	1	W
I <sub>B</sub>	Base current	DC	20	A
-I <sub>CSM</sub>	Surge collector reverse current (forward diode current)	Peak value of one cycle of 60Hz (half wave)	200	A
T <sub>j</sub>	Junction temperature		-40~+150	°C
T <sub>stg</sub>	Storage temperature		-40~+125	°C
V <sub>iso</sub>	Isolation voltage	Main terminal to case, AC for 1 minute	2500	V
—	Mounting torque	Main terminal screw M4	0.98~1.47	N·m
			10~15	kg·cm
		Mounting screw M5	1.47~1.96	N·m
			15~20	kg·cm
		B terminal screw M4	0.98~1.47	N·m
	10~15	kg·cm		
—	Weight	Typical value	90	g

**ELECTRICAL CHARACTERISTICS** (T<sub>j</sub>=25°C, unless otherwise noted)

Symbol	Parameter	Test conditions	Limits			Unit
			Min.	Typ.	Max.	
I <sub>CX</sub>	Collector cutoff current	V <sub>CE</sub> =600V, V <sub>EB</sub> =2V	—	—	1.0	mA
I <sub>CB0</sub>	Collector cutoff current	V <sub>CB</sub> =600V, Emitter open	—	—	1.0	mA
I <sub>EB0</sub>	Emitter cutoff current	V <sub>EB</sub> =7V, Collector open	—	—	40	mA
V <sub>CE (sat)</sub>	Collector-emitter saturation voltage	I <sub>C</sub> =20A, I <sub>B</sub> =80mA	—	—	2.0	V
V <sub>BE (sat)</sub>	Base-emitter saturation voltage	I <sub>C</sub> =20A, I <sub>B</sub> =80mA	—	—	2.5	V
-V <sub>CEO</sub>	Collector-emitter reverse voltage	I <sub>C</sub> =-20A (diode forward voltage)	—	—	1.5	V
h <sub>FE</sub>	DC current gain	I <sub>C</sub> =20A, V <sub>CE</sub> =2.0V	250	—	—	—
t <sub>on</sub>	Switching time	V <sub>CC</sub> =300V, I <sub>C</sub> =20A, I <sub>B1</sub> =120mA, -I <sub>B2</sub> =400mA	—	—	1.5	μs
t <sub>s</sub>			—	—	1.2	μs
t <sub>f</sub>			—	—	2.0	μs
t <sub>r</sub>			—	—	2.0	μs
R <sub>th(j-c)Q</sub>	Thermal resistance (junction to case)	Transistor part	—	—	0.8	°C/W
R <sub>th(j-c)R</sub>		Diode part	—	—	2.2	°C/W
R <sub>th(c-f)</sub>	Contact thermal resistance (case to fin)	Conductive grease applied	—	—	0.15	°C/W

# QM20HA-HB

MEDIUM POWER SWITCHING USE  
INSULATED TYPE

## PERFORMANCE CURVES

**COMMON EMITTER OUTPUT CHARACTERISTICS (TYPICAL)**

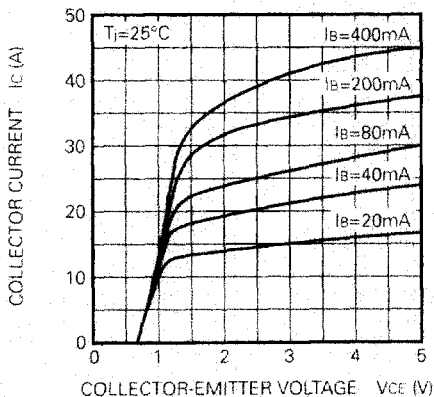

**DC CURRENT GAIN VS. COLLECTOR CURRENT (TYPICAL)**

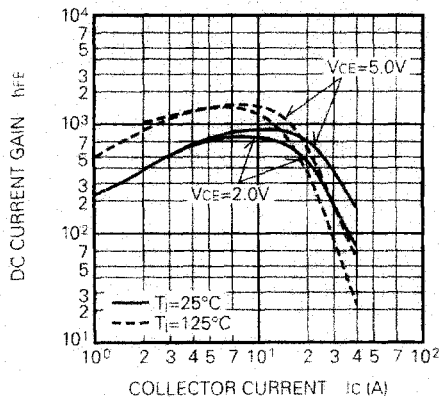

**COMMON EMITTER INPUT CHARACTERISTIC (TYPICAL)**

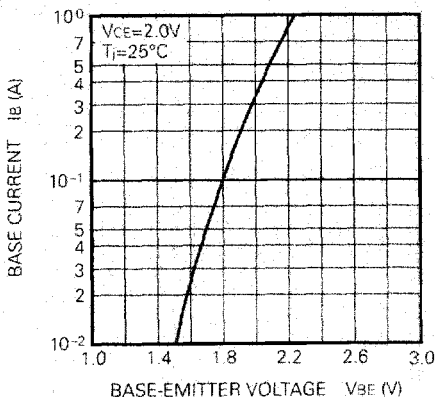

**SATURATION VOLTAGE CHARACTERISTICS (TYPICAL)**

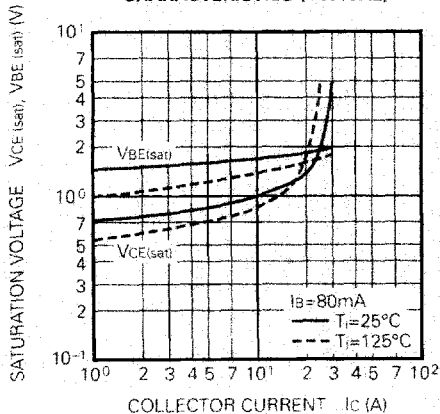

**COLLECTOR-EMITTER SATURATION VOLTAGE (TYPICAL)**

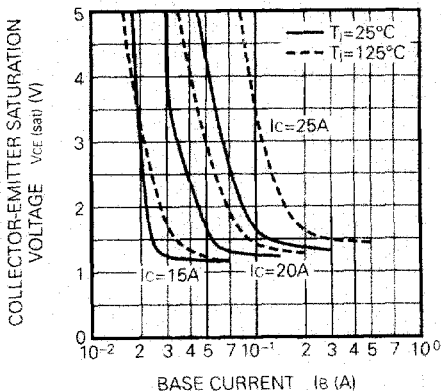

**SWITCHING TIME VS. COLLECTOR CURRENT (TYPICAL)**

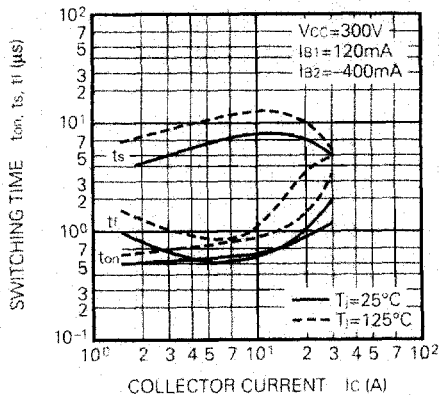

**QM20HA-HB**

MEDIUM POWER SWITCHING USE  
INSULATED TYPE

**SWITCHING TIME VS. BASE CURRENT (TYPICAL)**

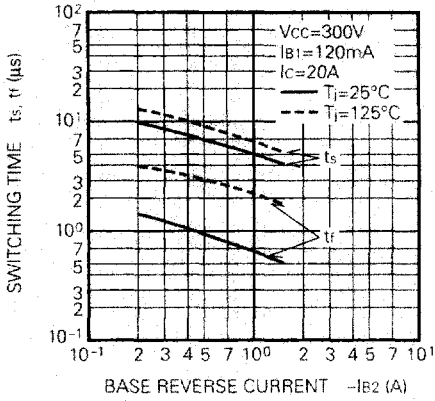

**REVERSE BIAS SAFE OPERATING AREA**

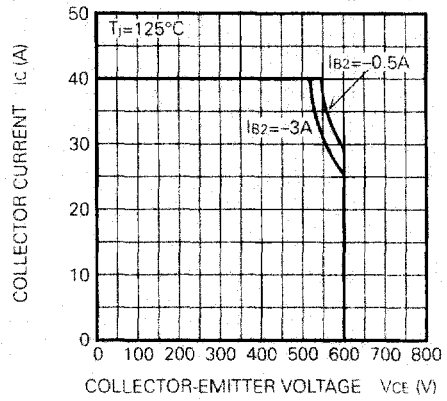

**FORWARD BIAS SAFE OPERATING AREA**

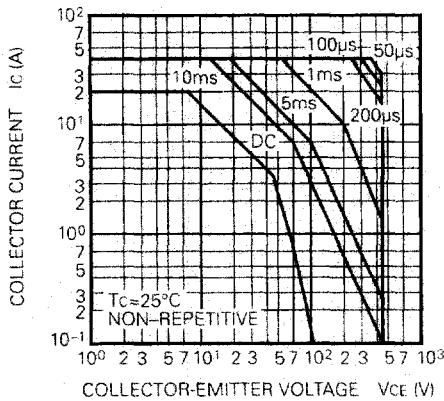

**DERATING FACTOR OF F. B. S. O. A.**

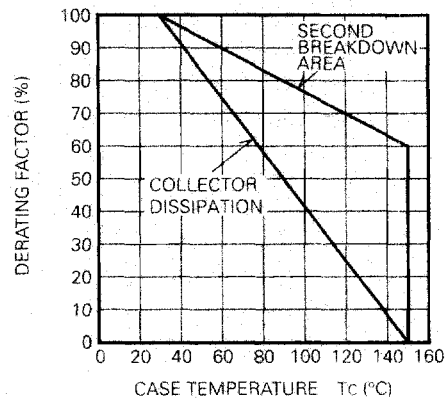

**TRANSIENT THERMAL IMPEDANCE CHARACTERISTIC (TRANSISTOR)**

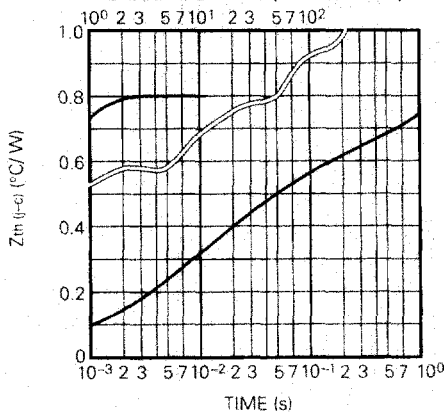

**REVERSE COLLECTOR CURRENT VS. COLLECTOR-EMITTER REVERSE VOLTAGE (DIODE FORWARD CHARACTERISTICS) (TYPICAL)**

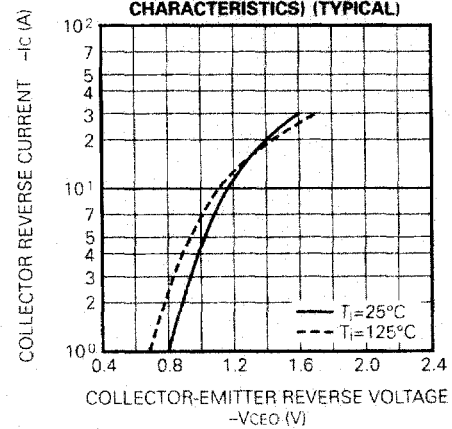

# QM20HA-HB

MEDIUM POWER SWITCHING USE  
INSULATED TYPE

**RATED SURGE COLLECTOR REVERSE CURRENT  
(DIODE FORWARD SURGE CURRENT)**

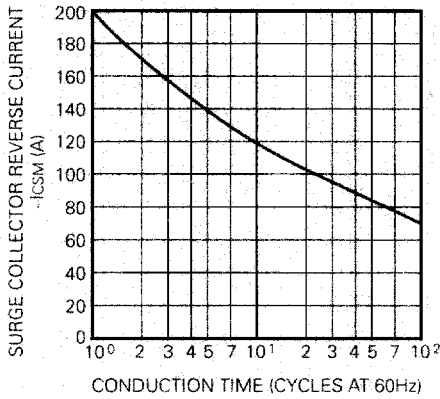

**REVERSE RECOVERY CHARACTERISTICS  
OF FREE-WHEEL DIODE (TYPICAL)**

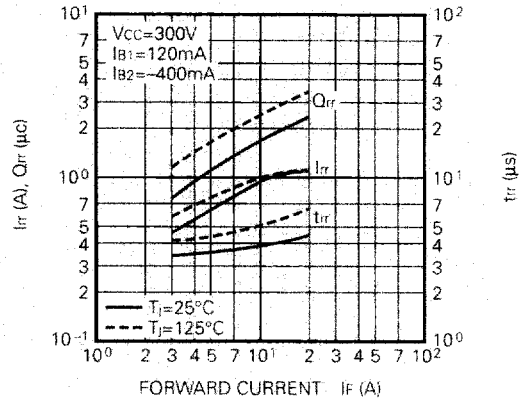

**TRANSIENT THERMAL IMPEDANCE  
CHARACTERISTIC (DIODE)**

