

THYRISTOR MODULE

PGH2008AM

200A / 800V

OUTLINE DRAWING

FEATURES

- * Isolated Base
- * 3 Phase Converter with Rush-Current Controllable Thyristor
- * High Surge Capability
- * UL Recognized, File No. E187184

TYPICAL APPLICATIONS

- * Converter For UPS , VVVF and Servo Motor Drive Amplifier

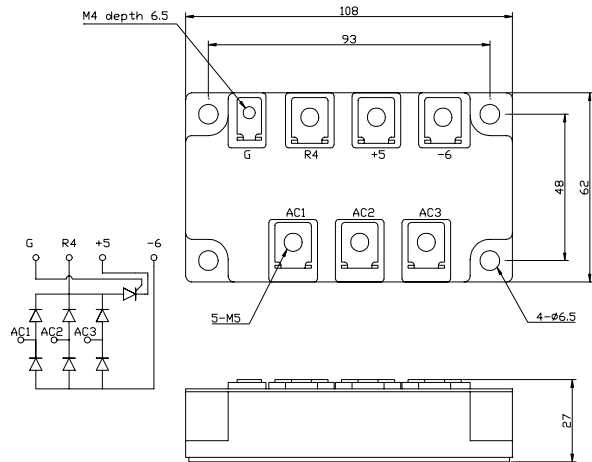

Approx Net Weight:530g

Pert of Diode Bridge and Thyristor Maximum Ratings

Parameter			Conditions		Max Rated Value	Unit
Average Rectified Output Current		$I_{O(AV)}$	3 Phase Full Wave Rectified	$T_c=93^{\circ}C$ (Non-Bias) $T_c=68^{\circ}C$ (Biased)	200	A
Operating Junction Temperature Range		T_{jw}	$T_j > 125^{\circ}C$, Can not be Biased for Thyristor.		-40 to +150	$^{\circ}C$
Storage Temperature Range		T_{stg}			-40 to +125	$^{\circ}C$
Isolation Voltage		Viso	Base Plate to Terminals, AC1min.		2000	V
Mounting torque	Case mounting	Ftor	Greased	M6 Screw	2.5 to 3.5	N.m
	Terminals			M6 Screw	2.5 to 3.5	
				M4 Screw	1.2 to 1.6	

Thermal Characteristics

Characteristics	Symbol	Test Conditions	Maximum Value.	Unit
Thermal Resistance	$R_{th(c-f)}$	Case to Fin, Total, Greased	0.06	$^{\circ}C/W$

Part of Diode Bridge (6 dies)

Maximum Ratings

Parameter	Symbol	Grade		Unit
		PGH2008AM		
Repetitive Peak Reverse Voltage *1	V_{RRM}	800		V
Non Repetitive Peak Reverse Voltage *1	V_{RSM}	900		

Parameter	Symbol	Conditions	Max Rated Value	Unit
Surge Forward Current *1	I_{FSM}	50 Hz Half Sine Wave, 1Pulse, Non-Repetitive	1800	A
I Squared t *1	I^2t	2msec to 10msec	16200	A^2s
Allowable Operating Frequency	f		400	Hz

*1 Value Per 1 Arm

Electrical • Thermal Characteristics

Characteristics	Symbol	Test Conditions	Maximum Value.			Unit
			Min.	Typ.	Max.	
Peak Reverse Current *1	I_{RM}	$V_{RM}= V_{RRM}, T_j= 125^{\circ}C$			20	mA
Peak Forward Voltage *1	V_{FM}	$I_{FM}= 200A, T_j=25^{\circ}C$			1.20	V
Thermal Resistance	$R_{th(j-c)}$	Junction to Case (Total)			0.10	$^{\circ}C/W$

*1 Value Per 1 Arm

Part of Thyristor (1 die)

Maximum Ratings

Parameter	Symbol	Grade		Unit
		PGH2008AM		
Repetitive Peak Off-State Voltage	V_{DRM}	800		V
Non Repetitive Peak Off-State Voltage	V_{DSM}	900		
Repetitive Peak Reverse Voltage	V_{RRM}	800		V
Non Repetitive Peak Reverse Voltage	V_{RSM}	900		

Parameter	Symbol	Conditions	Max Rated Value	Unit
I Squared t	I^2t	2msec to 10msec	51200	A^2s
Critical Rate of Turned-On Current	di/dt	$V_D=2/3V_{DRM}, I_{TM}=2 \cdot I_O, T_j=125^{\circ}C$ $I_G=300mA, di_G/dt=0.2A/\mu s$	100	$A/\mu s$
Peak Gate Power	P_{GM}		5	W
Average Gate Power	$P_{G(AV)}$		1	W
Peak Gate Current	I_{GM}		2	A
Peak Gate Voltage	V_{GM}		10	V
Peak Gate Reverse Voltage	V_{RGM}		5	V

Electrical • Thermal Characteristics

Characteristics	Symbol	Test Conditions	Maximum Value.			Unit
			Min.	Typ.	Max.	
Peak Off-State Current	I_{DM}	$V_{DM}= V_{DRM}, T_j= 125^{\circ}C$			30	mA
Peak Reverse Current	I_{RM}	$V_{RM}= V_{RRM}, T_j= 125^{\circ}C$			30	mA
Peak On-State Voltage	V_{TM}	$I_{TM}= 200A, T_j=25^{\circ}C$			1.23	V
Gate Current to Trigger	I_{GT}	$V_D=6V, I_T=1A$	$T_j=-40^{\circ}C$		300	mA
			$T_j=25^{\circ}C$		150	
			$T_j=125^{\circ}C$		80	
Gate Voltage to Trigger	V_{GT}	$V_D=6V, I_T=1A$	$T_j=-40^{\circ}C$		5.0	V
			$T_j=25^{\circ}C$		3.0	
			$T_j=125^{\circ}C$		2.0	
Gate Non-Trigger Voltage	V_{GD}	$V_D=2/3V_{DRM}, T_j=125^{\circ}C$	0.25			V
Critical Rate of Rise of Off-State Voltage	dv/dt	$V_D=2/3V_{DRM}, T_j=125^{\circ}C$	500			$V/\mu s$
Turn-Off Time	t_q	$I_{TM}=I_O, V_D=2/3V_{DRM}$ $dv/dt=20V/\mu s, V_R=100V$ $-di/dt=20A/\mu s, T_j=125^{\circ}C$		150		μs
Turn-On Time	t_{gt}	$V_D=2/3V_{DRM}, T_j=125^{\circ}C$ $I_G=300mA, di_G/dt=0.2A/\mu s$		6		μs
Delay Time	t_d			2		μs
Rise Time	t_r			4		μs
Latching Current	I_L	$T_j=25^{\circ}C$		150		mA
Holding Current	I_H	$T_j=25^{\circ}C$		100		
Thermal Resistance	$R_{th(j-c)}$	Junction to Case			0.25	$^{\circ}C/W$

PGH2008AM OUTLINE DRAWING (Dimensions in mm)

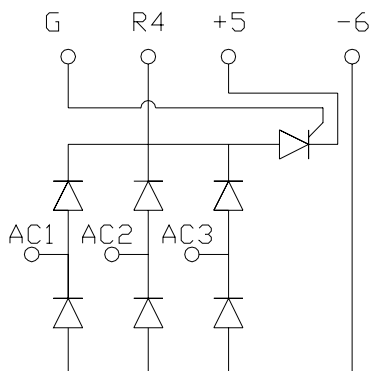
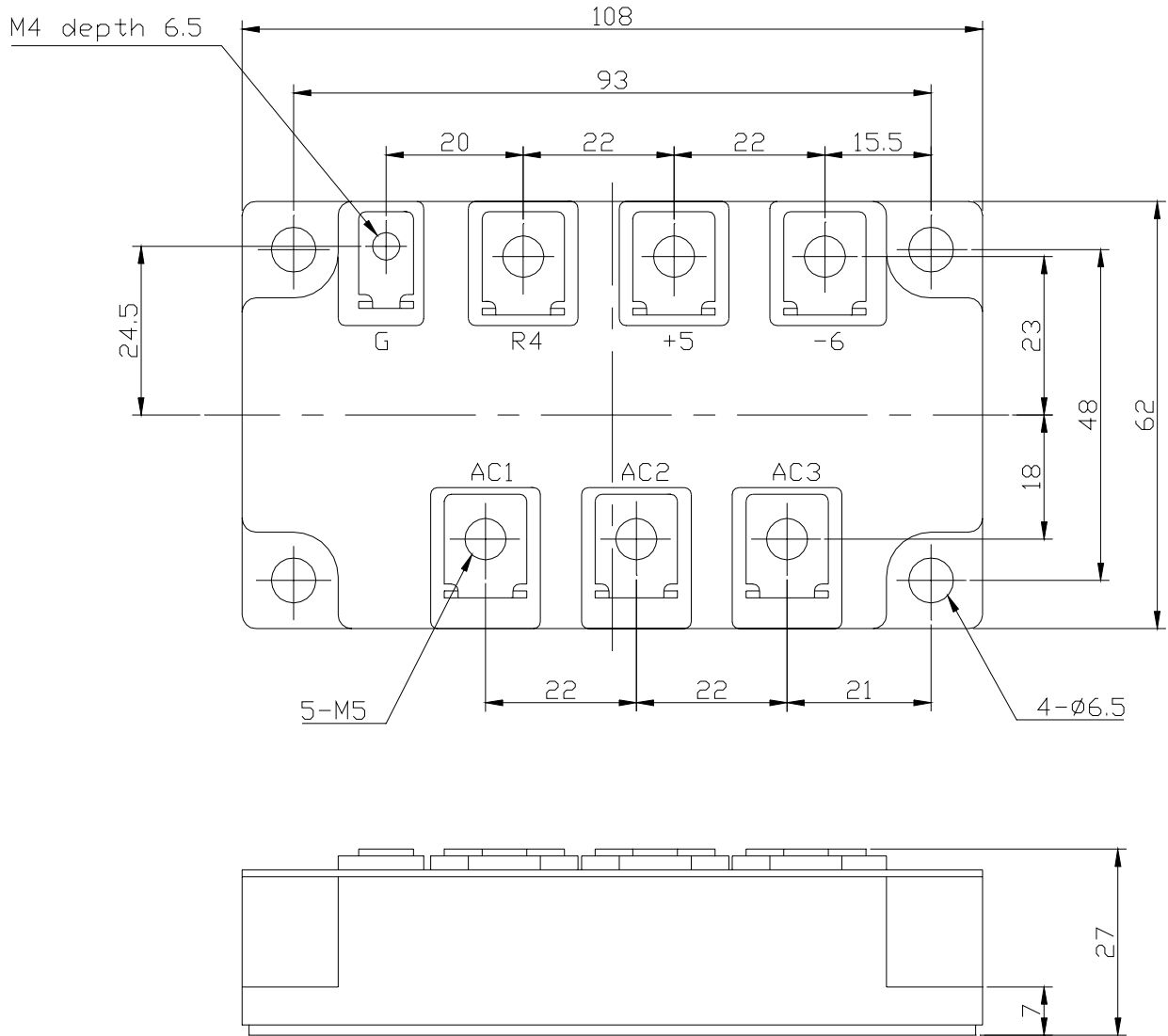

順電圧特性
FORWARD CURRENT VS. VOLTAGE

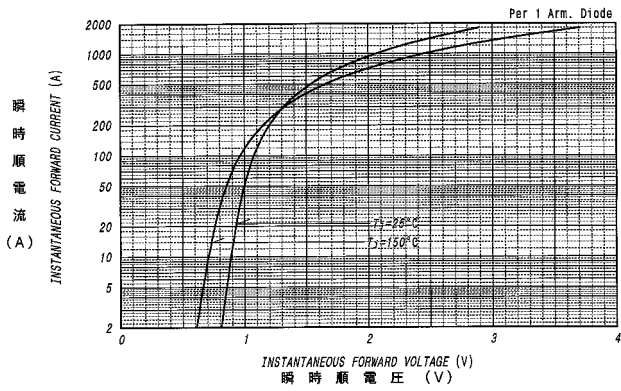

平均順電力損失特性
AVERAGE FORWARD POWER DISSIPATION

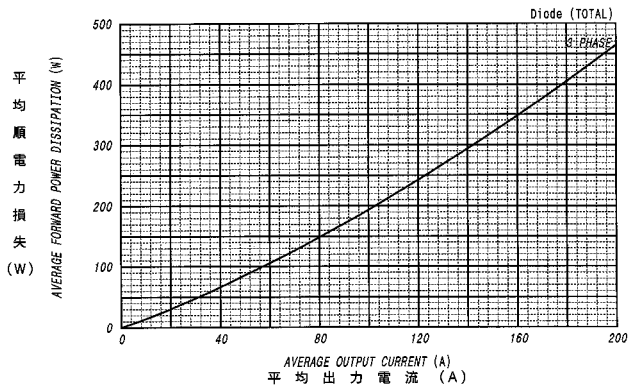

オン電圧特性
ON-STATE CURRENT VS. VOLTAGE

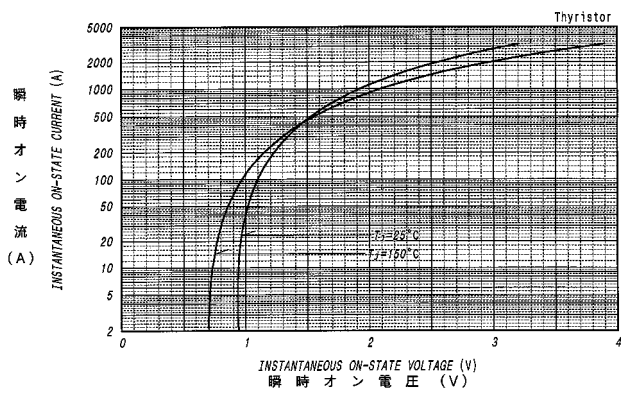

平均オン電力損失特性
AVERAGE ON-STATE POWER DISSIPATION

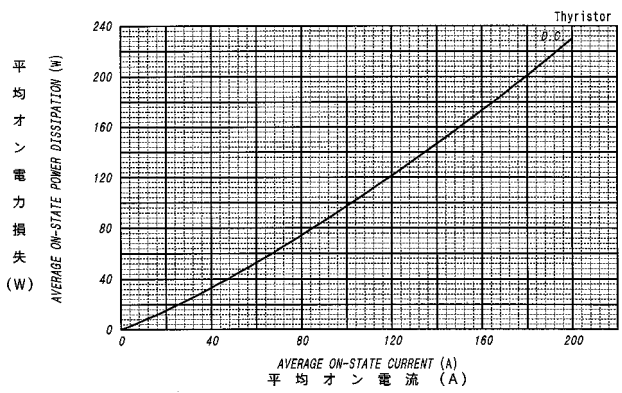

平均出力電流 - ケース温度定格
AVERAGE OUTPUT CURRENT VS. CASE TEMPERATURE
3-Phase Full Wave, Resistive or Inductive Load

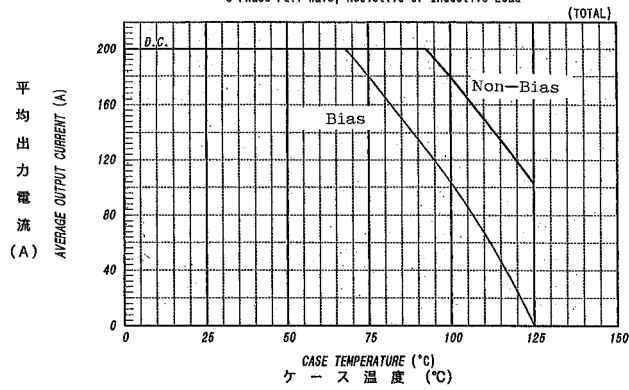

サージ電流定格
SURGE CURRENT RATINGS

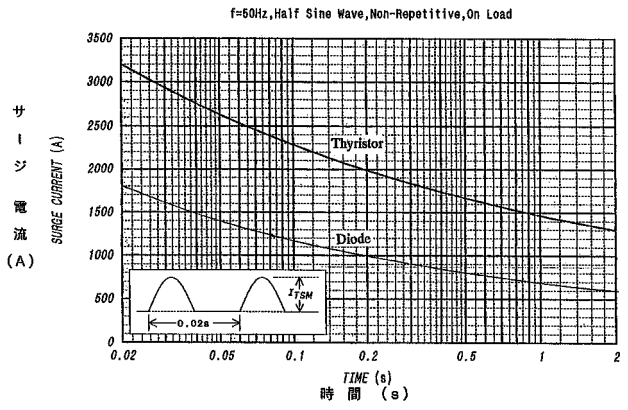

ゲート特性
GATE CHARACTERISTICS

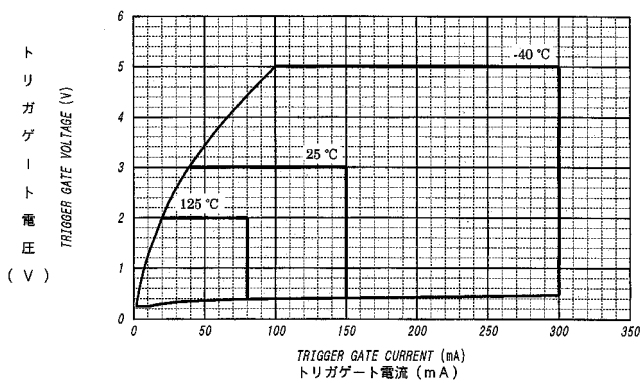

ゲート定格
GATE RATINGS

