

**FEATURES**

- \* Dual MOS FETs Cascaded Circuit
- \* Prevented Body Diodes of MOSFETs by SBDs, and Ultra Fast Recovery Diodes Connected in Parallel
- \* 300KHz High Speed Switching Possible

**TYPICAL APPLICATIONS**

- \* Power Supply for the Communications and the Induction Heating

**OUTLINE DRAWING**

Dimension(mm)

Circuit

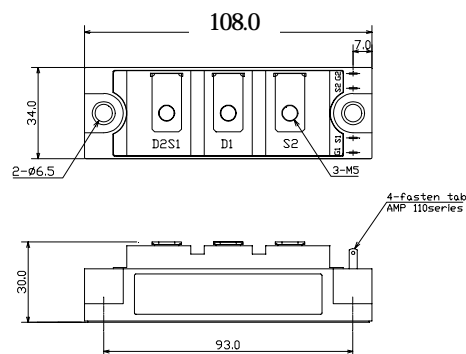
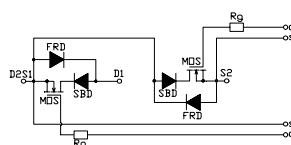

Approximate Weight : 220g

**MAXMUM RATINGS**

Ratings		Symbol	PD10M441H	PD10M440H	Unit
Drain-Source Voltage ( $V_{GS}=0V$ )		$V_{DSS}$	450	500	V
Gate - Source Voltage		$V_{GSS}$	+/- 20		V
Continuous Drain Current	Duty=50%	$I_D$	85 ( $T_c=25^\circ C$ )		A
	D.C.		60 ( $T_c=25^\circ C$ )		
Pulsed Drain Current		$I_{DM}$	170 ( $T_c=25^\circ C$ )		A
Total Power Dissipation		$P_D$	730 ( $T_c=25^\circ C$ )		W
Operating Junction Temperature Range		$T_{jw}$	-40 to +150		$^\circ C$
Storage Temperature Range		$T_{sg}$	-40 to +125		$^\circ C$
Isolation Voltage (Terminals to Base AC, 1 min.)		$V_{ISO}$	2000		V
Mounting Torque	Module Base to Heatsink	$F_{TOR}$	3.0		N•m
	Bus Bar to Main Terminals		2.0		

**ELECTRICAL CHARACTERISTICS (@ $T_c=25^\circ C$  unless otherwise noted)**

Characteristic	Symbol	Test Condition	Min.	Typ.	Max.	Unit
Zero Gate Voltage Drain Current	$I_{DSS}$	$V_{DS}=V_{DSS}, V_{GS}=0V$	-	-	1.0	mA
		$T_j=125^\circ C, V_{DS}=V_{DSS}, V_{GS}=0V$	-	-	4.0	
Gate-Source Threshold Voltage	$V_{GS(th)}$	$V_{DS}=V_{GS}, I_D=1mA$	2.0	3.1	4.0	V
Gate-Source Leakage Current	$I_{GSS}$	$V_{GS}=\pm 20V, V_{DS}=0V$	-	-	1.0	$\mu A$
Static Drain-Source On-Resistance	$r_{DS(on)}$	$V_{GS}=10V, I_D=40A$	-	75	85	m-ohm
Drain-Source On-Voltage	$V_{DS(on)}$	$V_{GS}=10V, I_D=40A$	-	3.5	3.9	V
Forward Transconductance	$g_{fs}$	$V_{DS}=15V, I_D=40A$	-	65	-	S
Input Capacitance	$C_{ies}$	$V_{DS}=25V, V_{GS}=0V, f=1MHz$	-	13	-	nF
Output Capacitance	$C_{oss}$		-	2.2	-	nF
Reverse Transfer Capacitance	$C_{iss}$		-	0.45	-	nF
Turn-On Delay Time	$t_{d(on)}$	$V_{DD}=1/2V_{DSS}$	-	140	-	ns
Rise Time	$t_r$	$I_D=40A$	-	110	-	
Turn-Off Delay Time	$t_{d(off)}$	$V_{GS}=-5V, +10V$	-	300	-	
Fall Time	$t_f$	$R_C=7\Omega$	-	50	-	

**FREE WHEELING DIODES RATINGS & CHARACTERISTICS ( $T_c=25^\circ C$ )**

Characteristic	Symbol	Test Condition	Min.	Typ.	Max.	Unit
Continuous Source Current	$I_S$	D.C.	-	-	60	A
Pulsed Source Current	$I_{SM}$	-	-	-	170	A
Diode Forward Voltage	$V_{SD}$	$I_S=85A$	-	-	2.0	V
Reverse Recovery Time	$t_{rr}$	$I_S=85A, -dis/dt=100A/\mu s$	-	100	-	ns
Reverse Recovery	$Q_r$		-	0.15	-	$\mu C$

**THERMAL CHARACTERISTICS**

Characteristic	Symbol	Test Condition	Min.	Typ.	Max.	Unit
Thermal Resistance, Junction to Case	$R_{th(j-c)}$	MOS FET	-	-	0.171	$^\circ C/W$
		Diode	-	-	1.2	
Thermal Resistance, Case to Heatsink	$R_{th(c-h)}$	Mounting surface flat, smooth, and greased	-	-	0.1	$^\circ C/W$

PD10M44xH

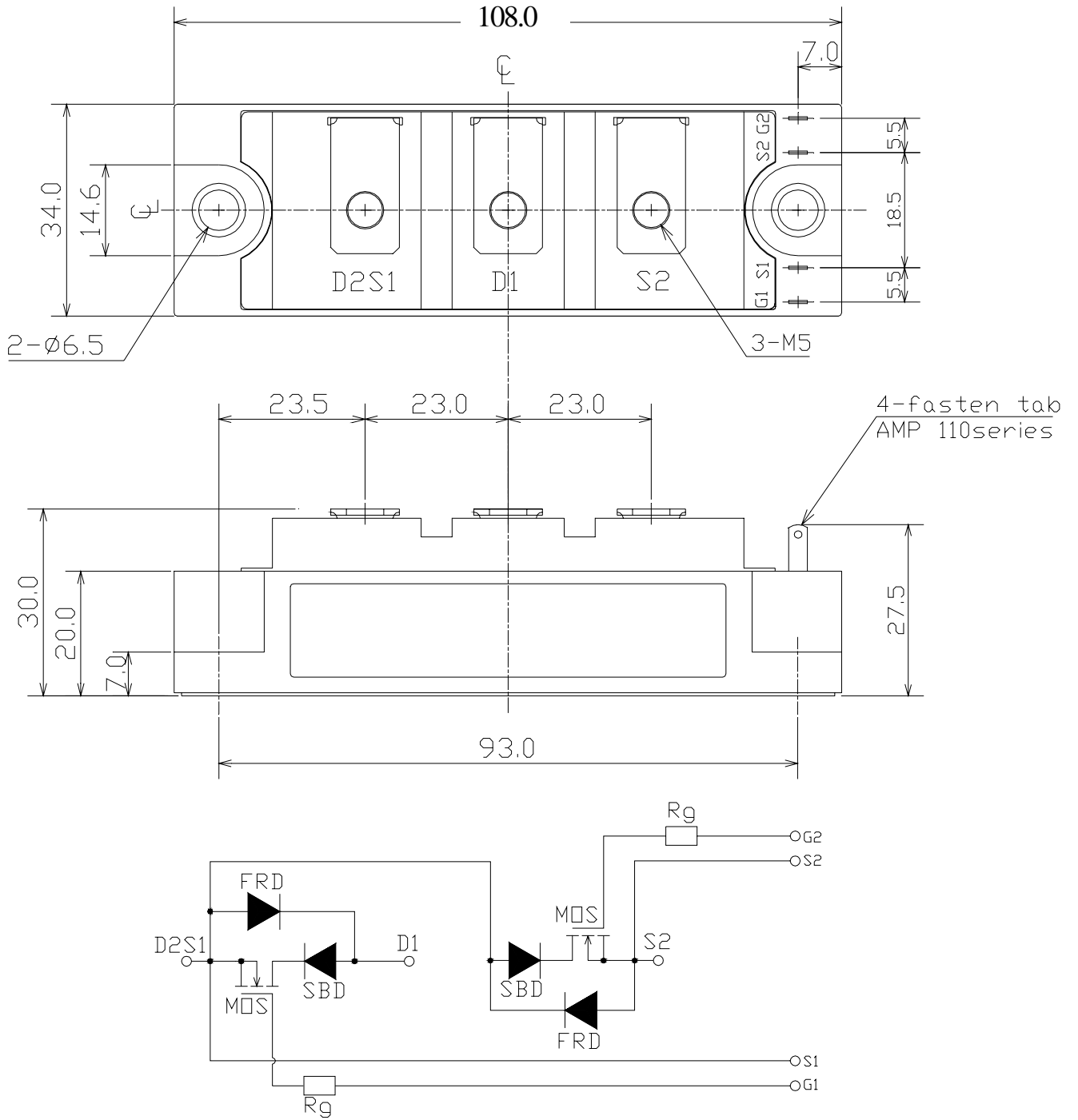

Fig. 1 Typical Output Characteristics

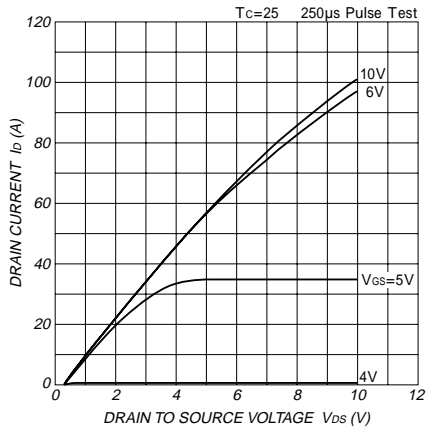

Fig. 2 Typical Drain-Source On-Voltage Vs. Gate-Source Voltage

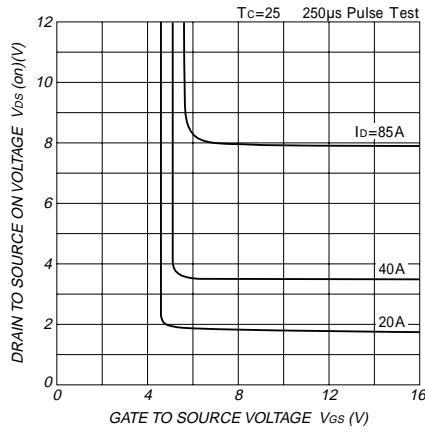

Fig. 3 Typical Drain-Source On Voltage Vs. Junction Temperature

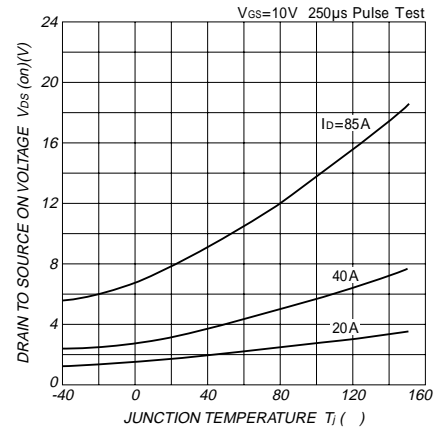

Fig. 4 Typical Capacitance Vs. Drain-Source Voltage

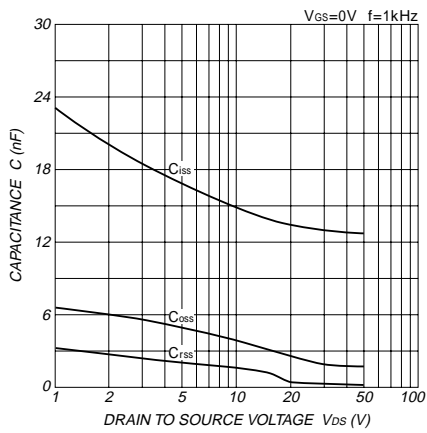

Fig. 5 Typical Gate Charge Vs. Gate-Source Voltage

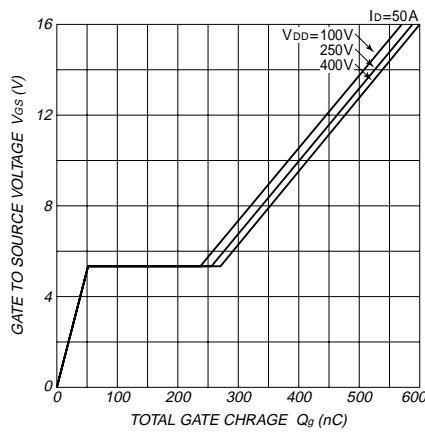

Fig. 6 Typical Switching Time Vs. Series Gate Impedance

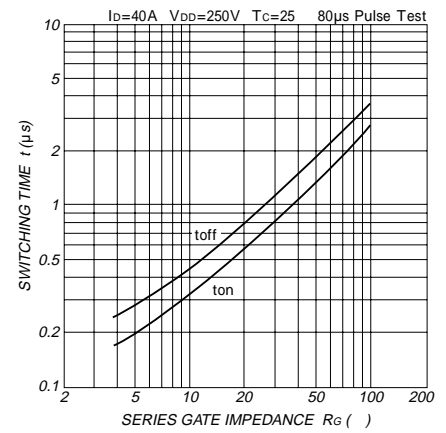

Fig. 7 Typical Switching Time Vs. Drain Current

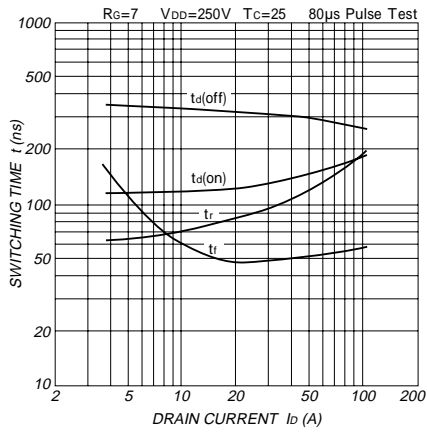

Fig. 8 Typical Source-Drain Diode Forward Characteristics

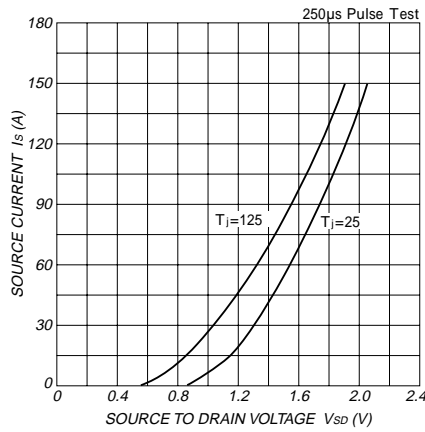

Fig. 9 Typical Reverse Recovery Characteristics

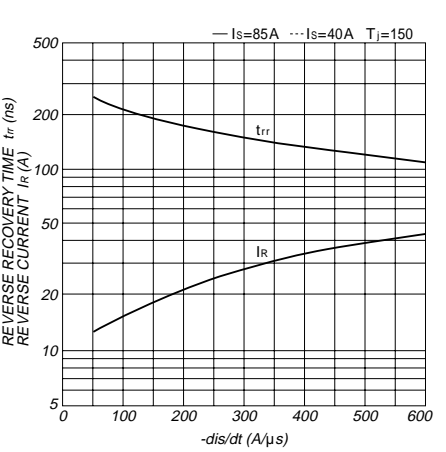

Fig. 10 Maximum Safe Operating Area

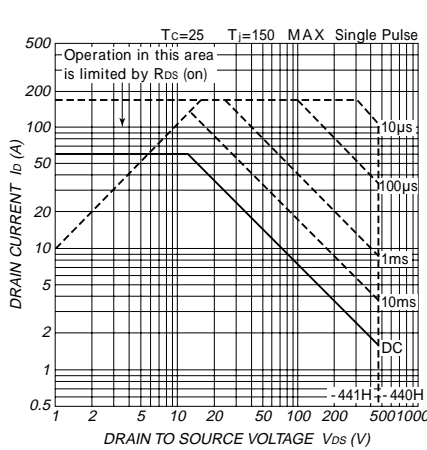

Fig. 11-1 Normalized Transient Thermal Impedance(MOSFET)

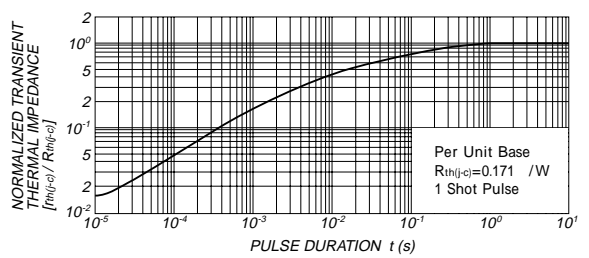

Fig. 11-2 Normalized Transient Thermal Impedance(DIODE)

