

TOSHIBA POWER MOS FET MODULE SILICON P CHANNEL MOS TYPE (L²-π-MOSV 4 IN 1)

MP4211

HIGH POWER, HIGH SPEED SWITCHING APPLICATIONS
 FOR PRINTER HEAD PIN DRIVER AND PULSE MOTOR DRIVER
 FOR SOLENOID DRIVER

INDUSTRIAL APPLICATIONS
 Unit in mm

- 4 V Gate Drive Available
- Small Package by Full Molding (SIP 10 Pin)
- High Drain Power Dissipation (4 Devices Operation)
 : P_T = 4 W (T_a = 25°C)
- Low Drain-Source ON Resistance : R_{DS(ON)} = 0.16 Ω (typ.)
- High Forward Transfer Admittance : |Y_{fs}| = 4.0 S (typ.)
- Low Leakage Current : I_{GSS} = ±10 μA (max.) (V_{GS} = ±16 V)
 I_{DSS} = -100 μA (max.) (V_{DS} = -60 V)
- Enhancement-Mode : V_{th} = -0.8 ~ -2.0 V
 (V_{DS} = -10 V, I_D = -1 mA)

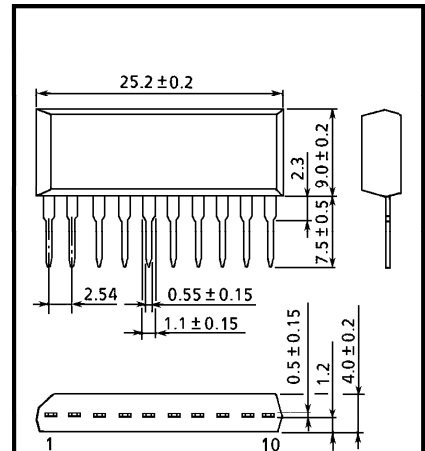

1, 10 SOURCE
 2, 4, 6, 8 GATE
 3, 5, 7, 9 DRAIN
 (PIN 1 AND PIN 10 IS DISCONNECTED INTERNALLY)

JEDEC	—
EIAJ	—
TOSHIBA	2-25A1C

Weight : 2.1 g (typ.)

ARRAY CONFIGURATION

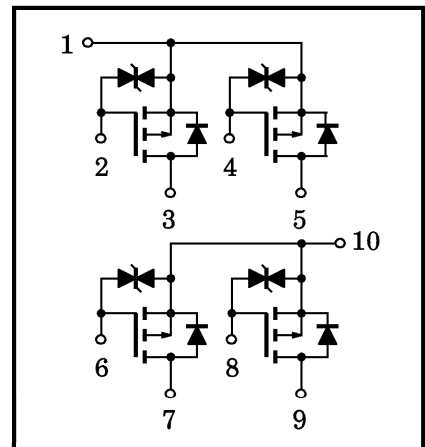

MAXIMUM RATINGS (T_a = 25°C)

CHARACTERISTIC		SYMBOL	RATING	UNIT
Drain-Source Voltage		V _{DSS}	-60	V
Drain-Gate Voltage (R _{GS} = 20 kΩ)		V _{DGR}	-60	V
Gate-Source Voltage		V _{GSS}	±20	V
Drain Current	DC	I _D	-5	A
	Pulse	I _{DP}	-20	
Drain Power Dissipation (1 Device Operation, T _a = 25°C)		P _D	2.0	W
Drain Power Dissipation (4 Devices Operation, T _a = 25°C)		P _{DT}	4.0	W
Single Pulse Avalanche Energy*		E _{AS}	273	mJ
Avalanche Current		I _{AR}	-5	A
Repetitive Avalanche Energy**	1 Device Operation	E _{AR}	0.2	mJ
	4 Devices Operation	E _{ART}	0.4	
Channel Temperature		T _{ch}	150	°C
Storage Temperature Range		T _{stg}	-55 ~ 150	°C

Note ;

* Avalanche energy (single pulse) applied condition

V_{DD} = -25 V, Starting T_{ch} = 25°C, L = 14.84 mH, R_G = 25 Ω, I_{AR} = -5 A

** Repetitive rating ; Pulse Width Limited by maximum channel temperature.

This transistor is an electrostatic sensitive device. Please handle with caution.

000707EAA2

● TOSHIBA is continually working to improve the quality and reliability of its products. Nevertheless, semiconductor devices in general can malfunction or fail due to their inherent electrical sensitivity and vulnerability to physical stress. It is the responsibility of the buyer, when utilizing TOSHIBA products, to comply with the standards of safety in making a safe design for the entire system, and to avoid situations in which a malfunction or failure of such TOSHIBA products could cause loss of human life, bodily injury or damage to property. In developing your designs, please ensure that TOSHIBA products are used within specified operating ranges as set forth in the most recent TOSHIBA products specifications. Also, please keep in mind the precautions and conditions set forth in the "Handling Guide for Semiconductor Devices," or "TOSHIBA Semiconductor Reliability Handbook" etc..

● The TOSHIBA products listed in this document are intended for usage in general electronics applications (computer, personal equipment, office equipment, measuring equipment, industrial robotics, domestic appliances, etc.). These TOSHIBA products are neither intended nor warranted for usage in equipment that requires extraordinarily high quality and/or reliability or a malfunction or failure of which may cause loss of human life or bodily injury ("Unintended Usage"). Unintended Usage include atomic energy control instruments, airplane or spaceship instruments, transportation instruments, traffic signal instruments, combustion control instruments, medical instruments, all types of safety devices, etc.. Unintended Usage of TOSHIBA products listed in this document shall be made at the customer's own risk.

THERMAL CHARACTERISTICS

CHARACTERISTIC	SYMBOL	MAX.	UNIT
Thermal Resistance of Channel to Ambient (4 Devices Operation, Ta = 25°C)	$\Sigma R_{th(ch-a)}$	31.2	°C / W
Maximum Lead Temperature for Soldering Purposes (3.2 mm from Case for t = 10 s)	T _L	260	°C

MARKING

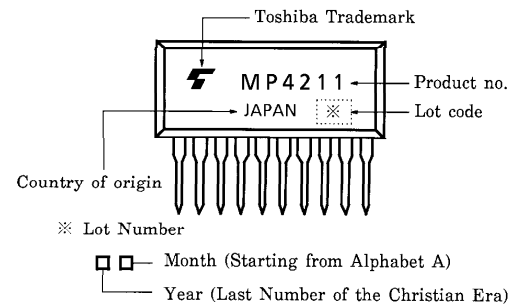

ELECTRICAL CHARACTERISTICS (Ta = 25°C)

CHARACTERISTIC	SYMBOL	TEST CONDITION	MIN.	TYP.	MAX.	UNIT	
Gate Leakage Current	I _{GSS}	V _{GS} = ±16 V, V _{DS} = 0 V	—	—	±10	μA	
Drain Cut-off Current	I _{DSS}	V _{DS} = -60 V, V _{GS} = 0 V	—	—	-100	μA	
Drain-Source Breakdown Voltage	V(BR) DSS	I _D = -10 mA, V _{GS} = 0 V	-60	—	—	V	
Gate Threshold Voltage	V _{th}	V _{DS} = -10 V, I _D = -1 mA	-0.8	—	-2.0	V	
Drain-Source ON Resistance	R _{DSON}	V _{GS} = -4 V, I _D = -2.5 A	—	0.24	0.28	Ω	
		V _{GS} = -10 V, I _D = -2.5 A	—	0.16	0.19		
Forward Transfer Admittance	Y _{fs}	V _{DS} = -10 V, I _D = -2.5 A	2.0	4.0	—	S	
Input Capacitance	C _{iss}	V _{DS} = -10 V, V _{GS} = 0 V, f = 1 MHz	—	630	—	pF	
Reverse Transfer Capacitance	C _{rss}		—	95	—		
Output Capacitance	C _{oss}		—	290	—		
Switching Time	Rise Time	t _r		—	25	—	ns
	Turn-on Time	t _{on}		—	45	—	
	Fall Time	t _f		—	55	—	
	Turn-off Time	t _{off}		—	200	—	
Total Gate Charge (Gate-Source Plus Gate-Drain)	Q _g	V _{DD} = -48 V, V _{GS} = -10 V, I _D = -5 A	—	22	—	nC	
Gate-Source Charge	Q _{gs}	—	—	16	—		
Gate-Drain ("Miller") Charge	Q _{gd}	—	—	6	—		

SOURCE-DRAIN DIODE RATINGS AND CHARACTERISTICS (Ta = 25°C)

CHARACTERISTIC	SYMBOL	TEST CONDITION	MIN.	TYP.	MAX.	UNIT
Continuous Drain Reverse Current	I _{DR}	—	—	—	-5	A
Pulse Drain Reverse Current	I _{DRP}	—	—	—	-20	A
Diode Forward Voltage	V _{DSF}	I _{DR} = -5 A, V _{GS} = 0 V	—	—	1.7	V
Reverse Recovery Time	t _{rr}	I _{DR} = -5 A, V _{GS} = 0 V	—	80	—	ns
Reverse Recovery Charge	Q _{rr}	dI _{DR} / dt = 50 A / μs	—	0.1	—	μC

000707EAA2'

- The information contained herein is presented only as a guide for the applications of our products. No responsibility is assumed by TOSHIBA CORPORATION for any infringements of intellectual property or other rights of the third parties which may result from its use. No license is granted by implication or otherwise under any intellectual property or other rights of TOSHIBA CORPORATION or others.
- The information contained herein is subject to change without notice.

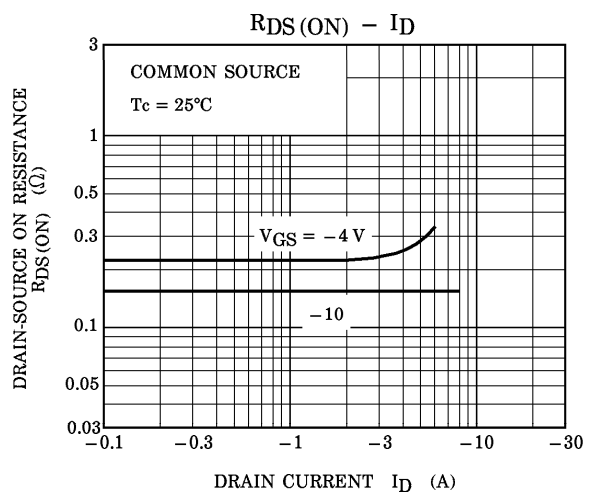
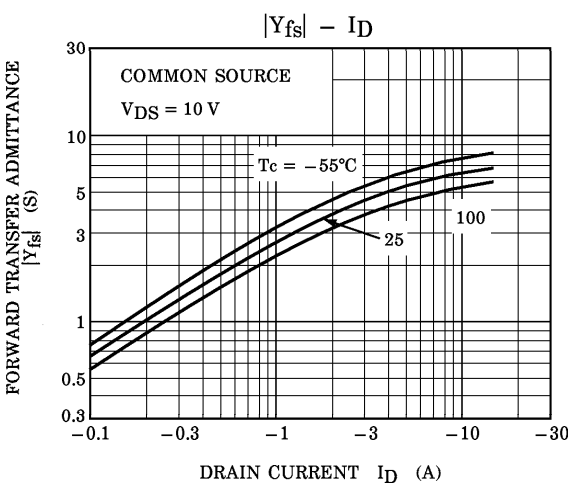
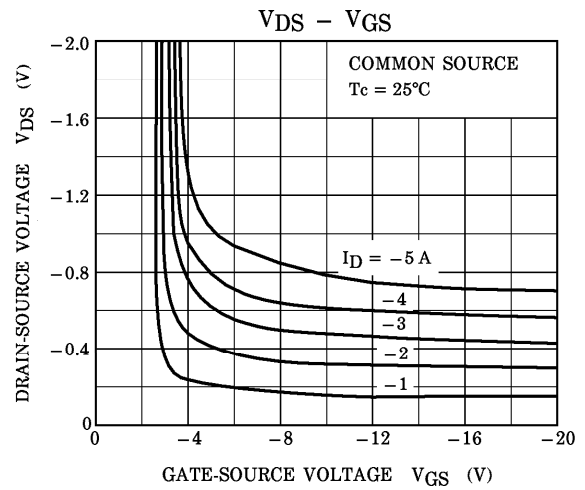
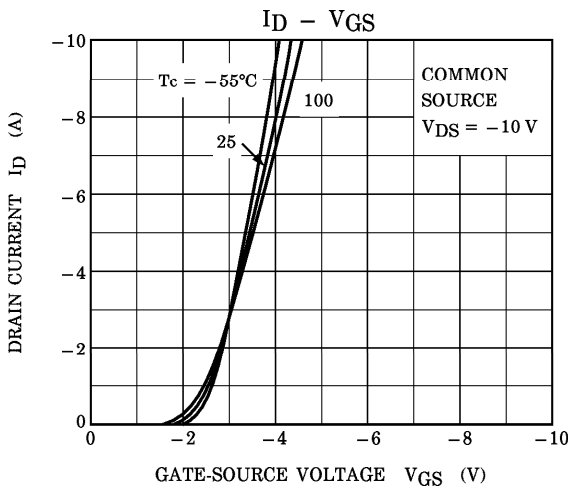
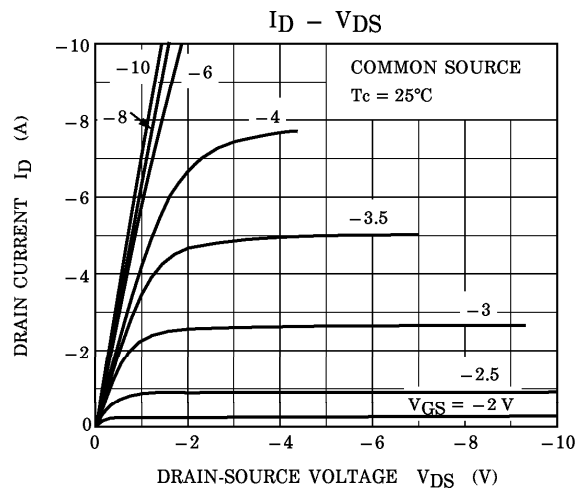
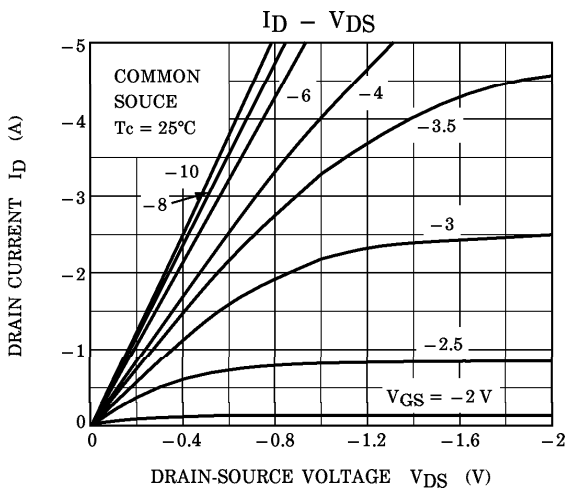

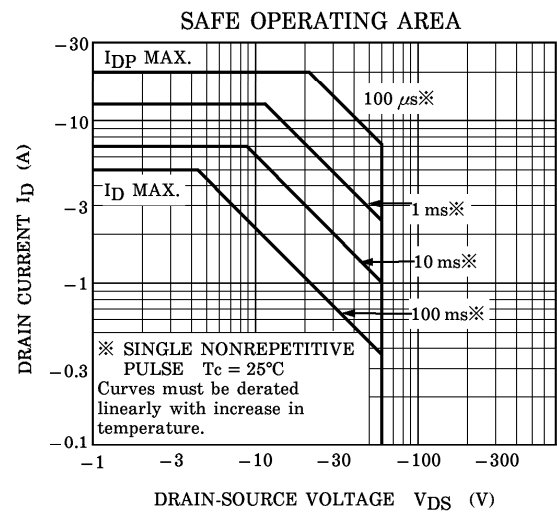
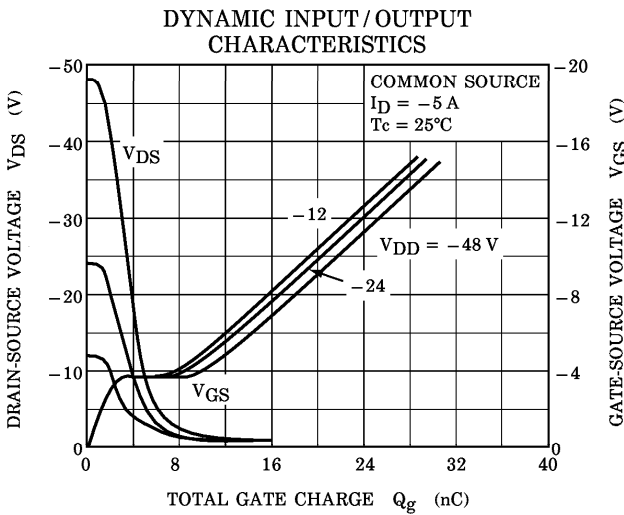
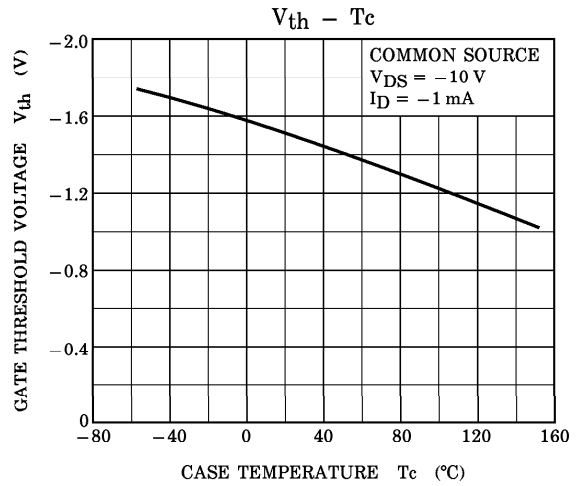
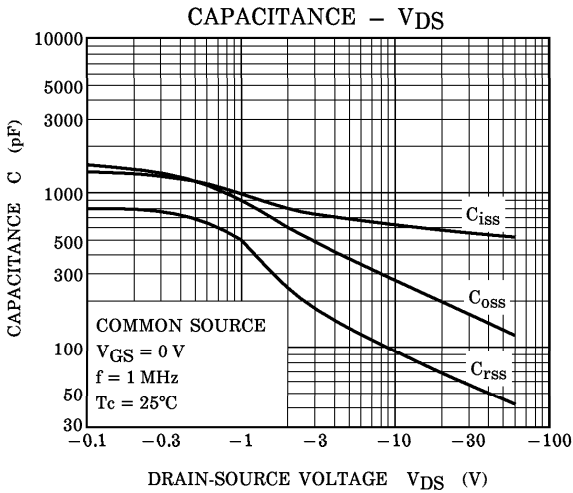
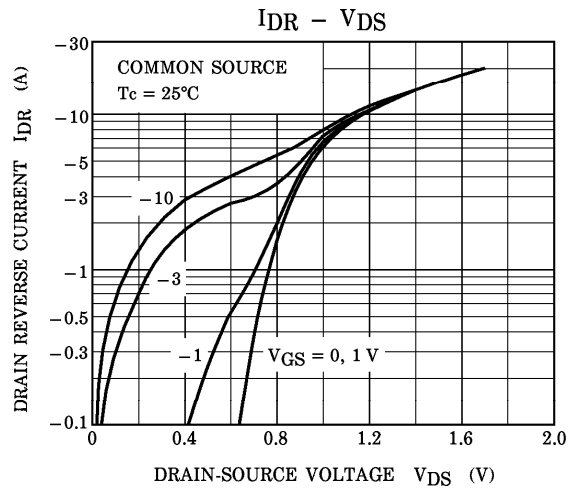
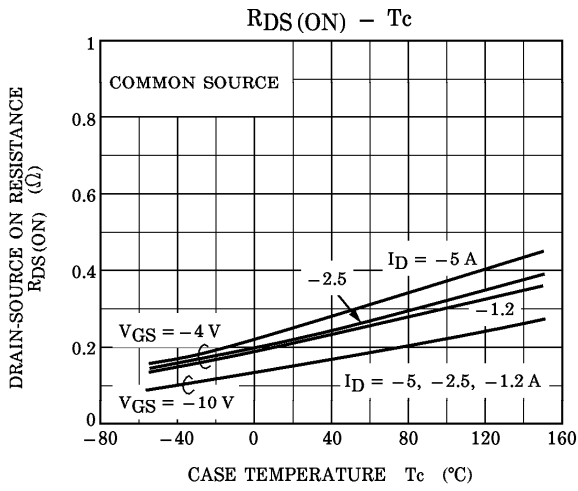

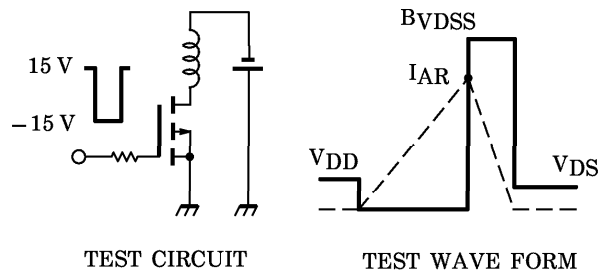
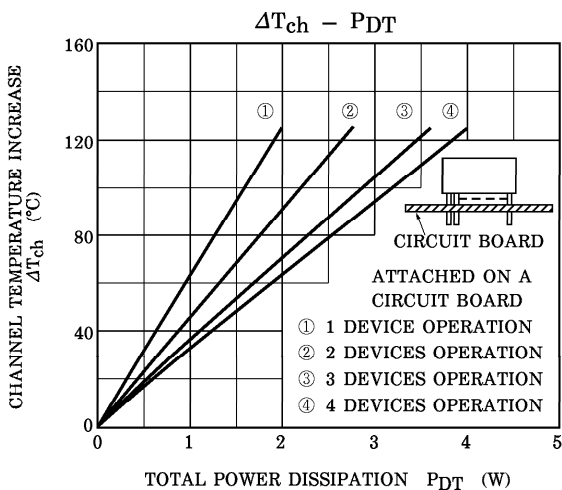
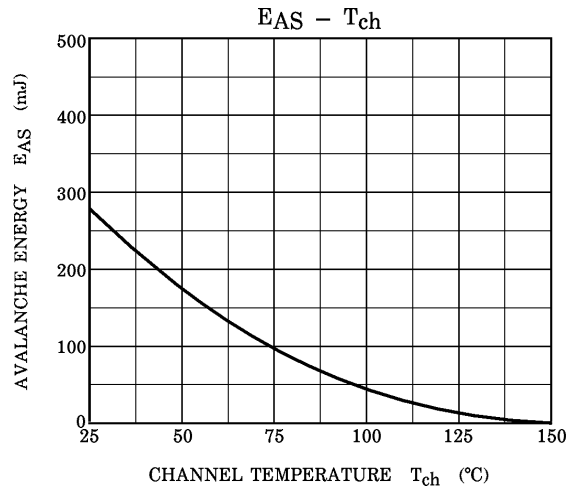
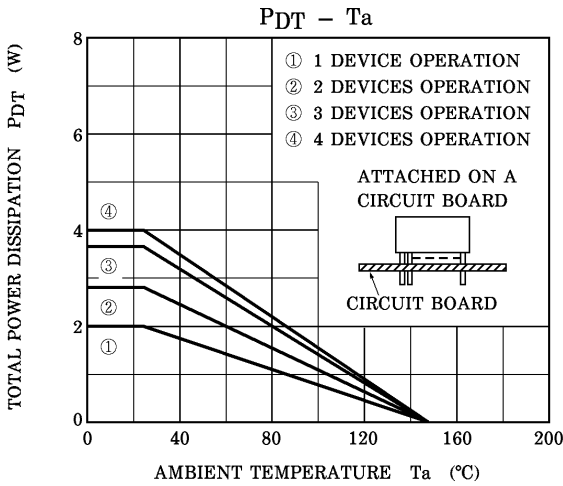
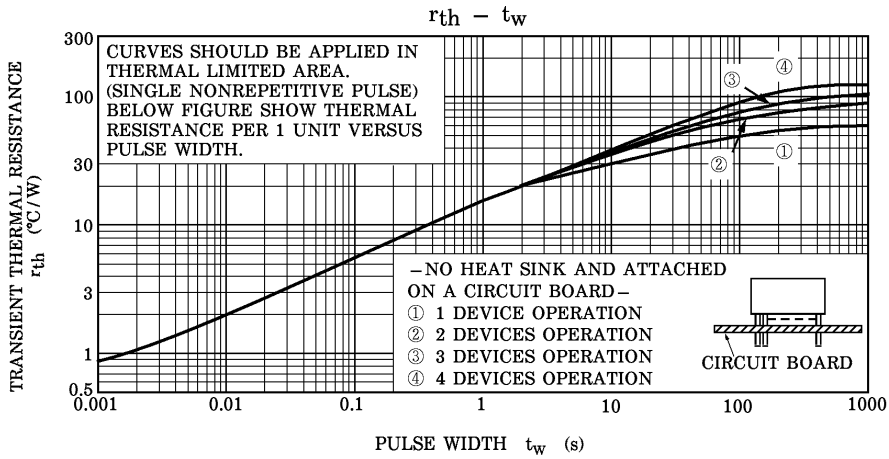

Peak $I_{AR} = -5$ A, $R_G = 25 \Omega$, $V_{DD} = -25$ V, $L = 14.84$ mH

$$E_{AS} = \frac{1}{2} \cdot L \cdot I^2 \left(\frac{BVDSS}{BVDSS - V_{DD}} \right)$$