

TENTATIVE TOSHIBA INTEGRATED IGBT MODULE SILICON N CHANNEL IGBT

MIG20J806H, MIG20J806HA

HIGH POWER SWITCHING APPLICATIONS

MOTOR CONTROL APPLICATIONS

- Integrates Inverter, Converter Power Circuits and Thermistor in One Package.
- Output (Inverter Stage)
: 3φ 20A / 600V IGBT
- Input (Converter Stage)
: 3φ 30A / 800V Silicon Rectifier
- The Electrodes are Isolated from Case.
- Outline
MIG20J806H : 2-108E5A
MIG20J806HA : 2-108E6A
- Weight : 190g

EQUIVALENT CIRCUIT

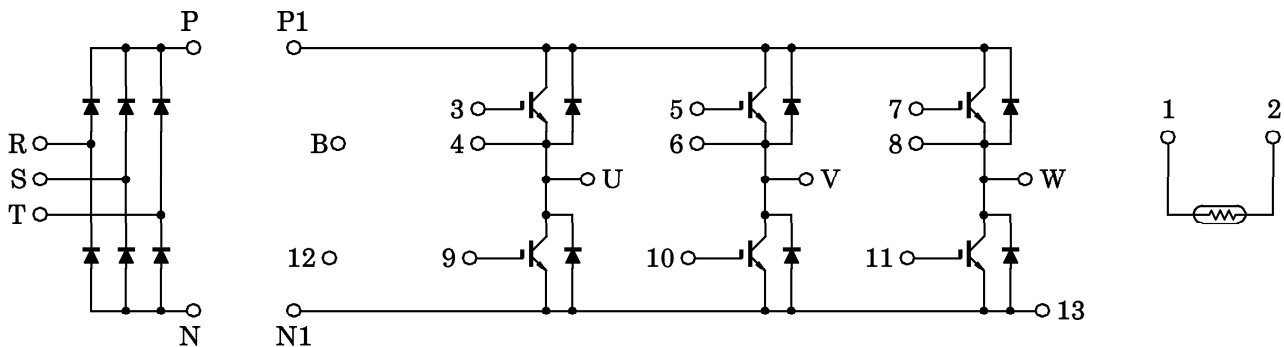

961001EAA2

- TOSHIBA is continually working to improve the quality and the reliability of its products. Nevertheless, semiconductor devices in general can malfunction or fail due to their inherent electrical sensitivity and vulnerability to physical stress. It is the responsibility of the buyer, when utilizing TOSHIBA products, to observe standards of safety, and to avoid situations in which a malfunction or failure of a TOSHIBA product could cause loss of human life, bodily injury or damage to property. In developing your designs, please ensure that TOSHIBA products are used within specified operating ranges as set forth in the most recent products specifications. Also, please keep in mind the precautions and conditions set forth in the TOSHIBA Semiconductor Reliability Handbook.
- The information contained herein is presented only as a guide for the applications of our products. No responsibility is assumed by TOSHIBA CORPORATION for any infringements of intellectual property or other rights of the third parties which may result from its use. No license is granted by implication or otherwise under any intellectual property or other rights of TOSHIBA CORPORATION or others.
- The information contained herein is subject to change without notice.

Package Dimension

Unit : mm

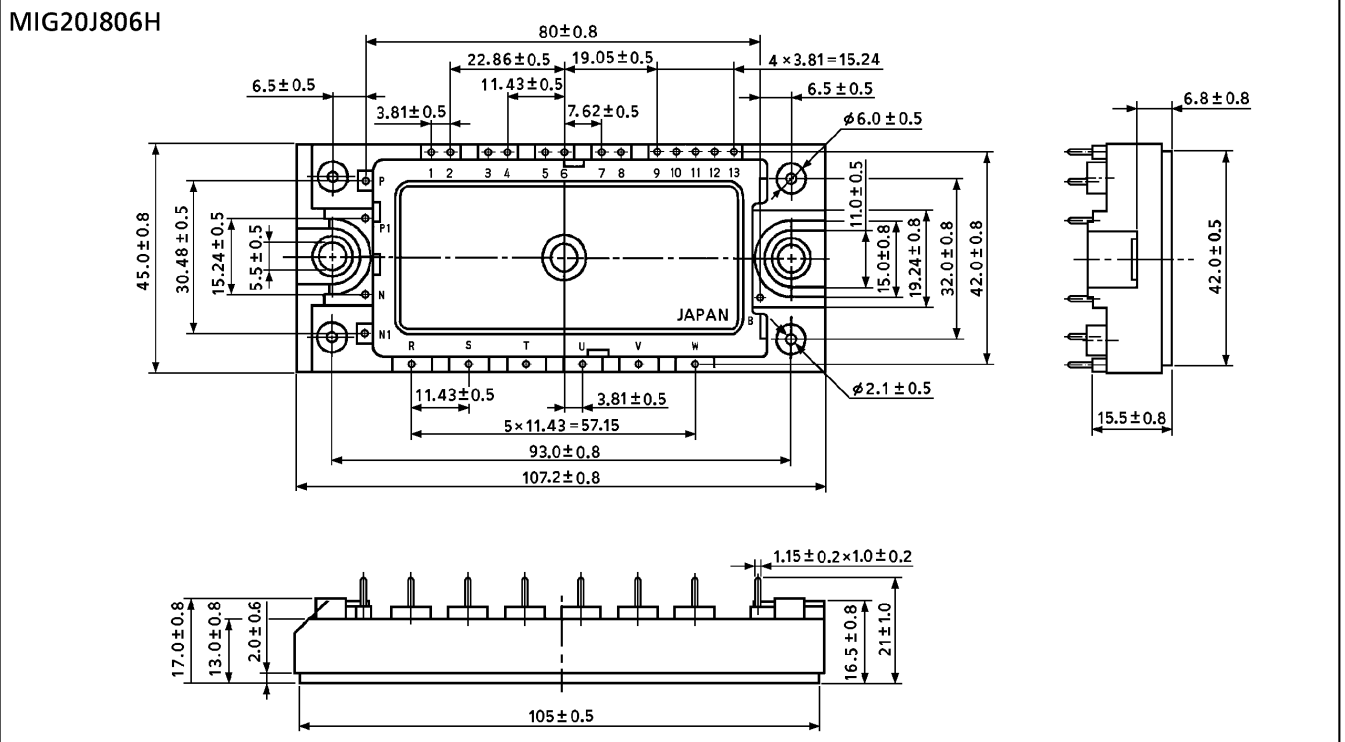

2-108E5A

Unit : mm

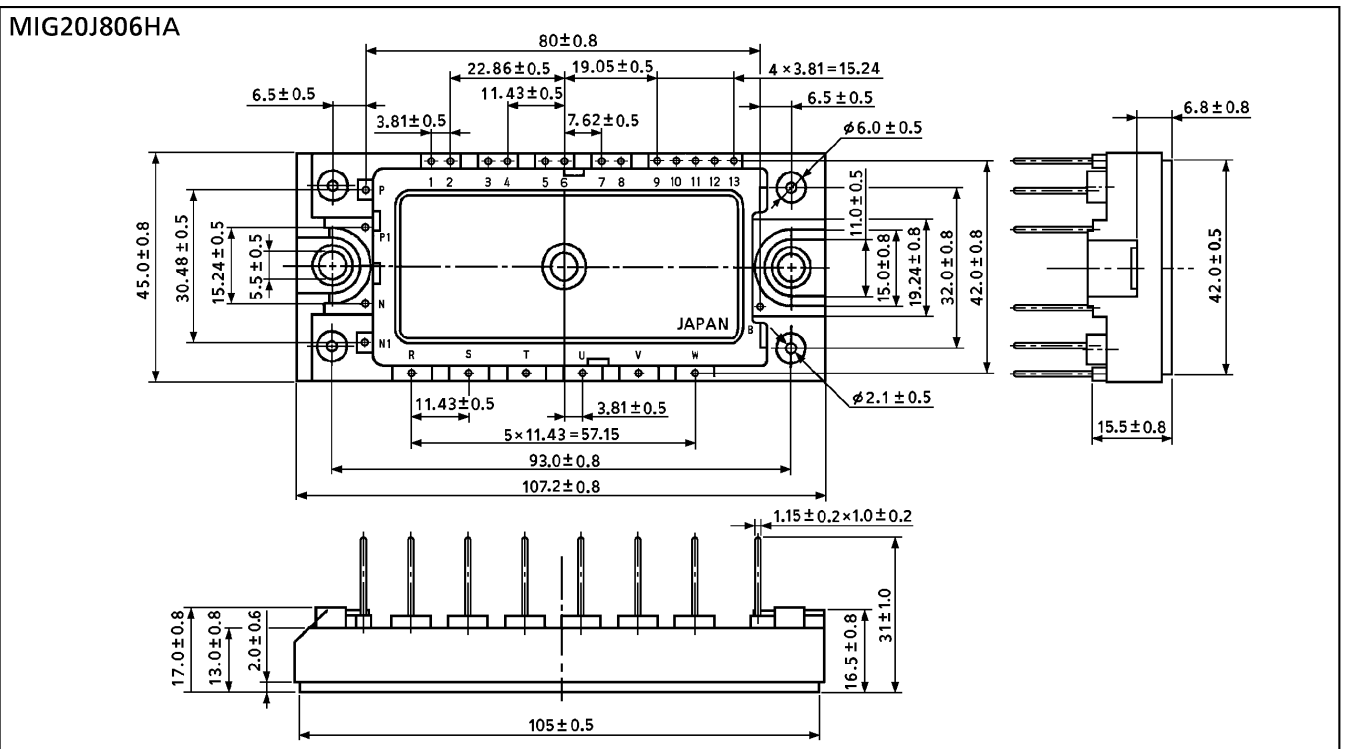

2-108E6A

MAXIMUM RATINGS (Ta = 25°C)

STAGE	CHARACTERISTIC	SYMBOL	RATING	UNIT	
Inverter	Collector-Emitter Voltage	V _{CES}	600	V	
	Gate-Emitter Voltage	V _{GES}	±20	V	
	Collector Current	DC	I _C	25 / 20	A
		1ms	I _{CP}	50 / 40	A
	Forward Current	DC	I _F	20	A
		1ms	I _{FM}	40	A
Collector Power Dissipation (T _c = 25°C)		P _C	90	W	
Converter	Repetitive Peak Reverse Voltage	V _{RRM}	800	V	
	Average Output Rectified Current	I _O	30	A	
	Peak One Cycle Surge Forward Current (50Hz, Non-Repetitive)	I _{FSM}	400	A	
Module	Junction Temperature	T _j	150	°C	
	Storage Temperature Range	T _{stg}	-40~125	°C	
	Isolation Voltage	V _{Isol}	2500 (AC 1 minute)	V	
	Screw Torque	—	6	N·m	

(25°C / 40°C)
(25°C / 40°C)

ELECTRICAL CHARACTERISTICS (Ta = 25°C)

a. Inverter stage

CHARACTERISTIC		SYMBOL	TEST CONDITION	MIN.	TYP.	MAX.	UNIT
Gate Leakage Current		IGES	VGE = ±20V, VCE = 0	—	—	±500	nA
Collector Cut-Off Current		ICES	VCE = 600V, VGE = 0	—	—	1.0	mA
Gate-Emitter Cut-Off Voltage		VGE (off)	IC = 2mA, VCE = 5V	5.0	—	8.0	V
Collector-Emitter Saturation Voltage		VCE (sat)	IC = 20A	—	2.1	2.7	V
			VGE = 15V		2.2	2.8	
Input Capacitance		Cies	VCE = 10V, VGE = 0, f = 1MHz	—	1850	—	pF
Switching Time	Rise Time	tr	VCC = 300V IC = 20A VGE = ±15V RG = 62Ω (Note 1)	—	0.10	0.20	μs
	Turn-On Time	ton		—	0.25	0.50	
	Fall Time	tf		—	0.15	0.30	
	Turn-Off Time	toff		—	0.50	0.80	
Forward Voltage		VF	IF = 20A, VGE = 0	—	2.0	2.8	V
Reverse Recovery Time		trr	IF = 20A, VGE = -10V di / dt = 100A / μs	—	0.08	0.15	μs
Thermal Resistance		Rth (j-c)	Transistor	—	—	1.39	°C / W
			Diode	—	—	2.6	

b. Converter stage

CHARACTERISTIC		SYMBOL	TEST CONDITION	MIN.	TYP.	MAX.	UNIT
Repetitive Peak Reverse Current		IRRM	VRRM = 800V	—	—	50	μA
Peak Forward Voltage		VFM	IFM = 30A	—	1.05	1.20	V
Peak One Cycle Surge Forward Current		IFSM	50Hz sine-half-wave	400	—	—	A
Thermal Resistance		Rth (j-c)	—	—	—	1.56	°C / W

c. Thermistor

CHARACTERISTIC		SYMBOL	TEST CONDITION	MIN.	TYP.	MAX.	UNIT
Zero-power Resistance		R25	ITM = 0.2mA, Tc = 25°C	17.31	20	23.14	kΩ
B Value		B25 / 85	Tc = 25°C / Tc = 85°C	—	3760	—	K

(Note 1) Switching Time Test Circuit & Timing Chart

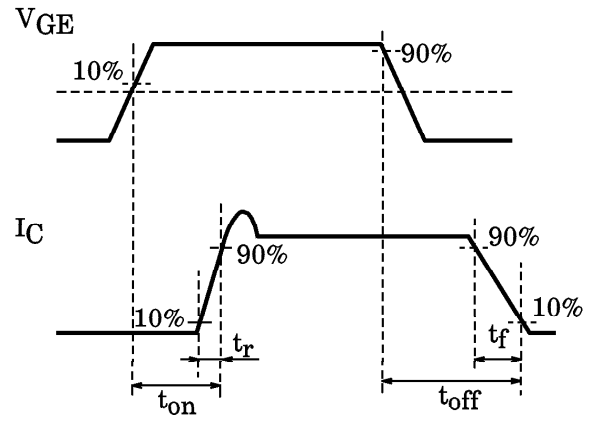
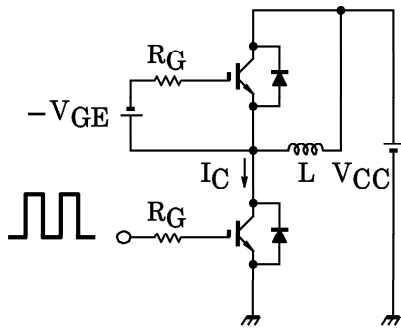

a. Inverter stage

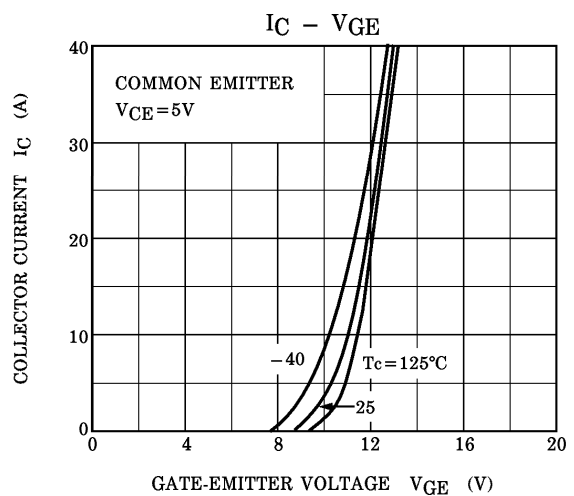
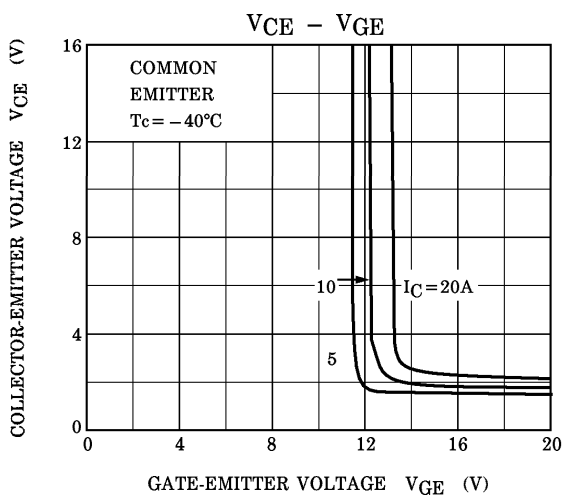
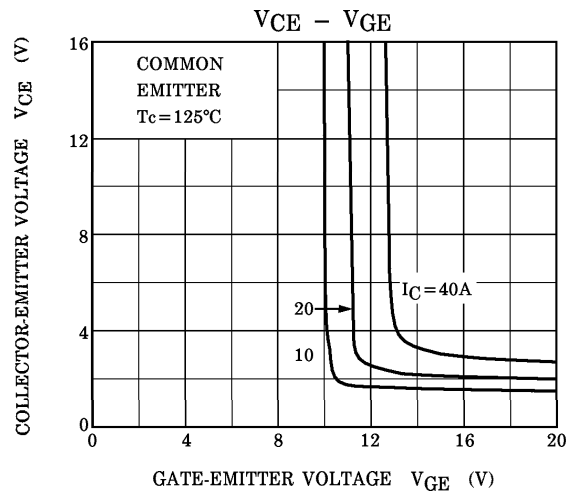
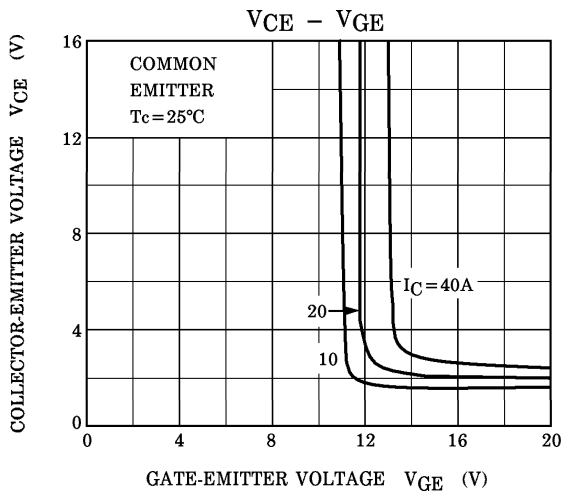
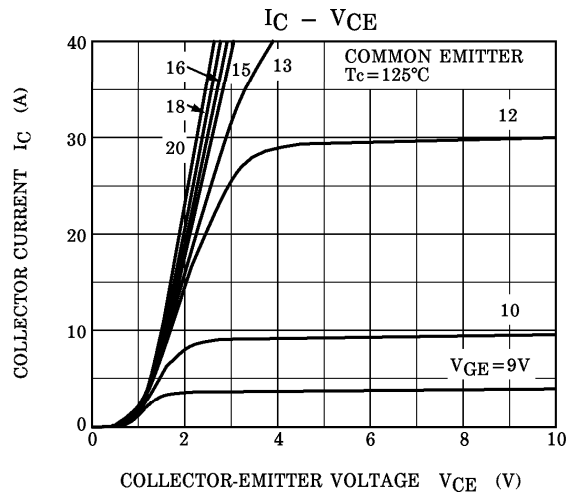
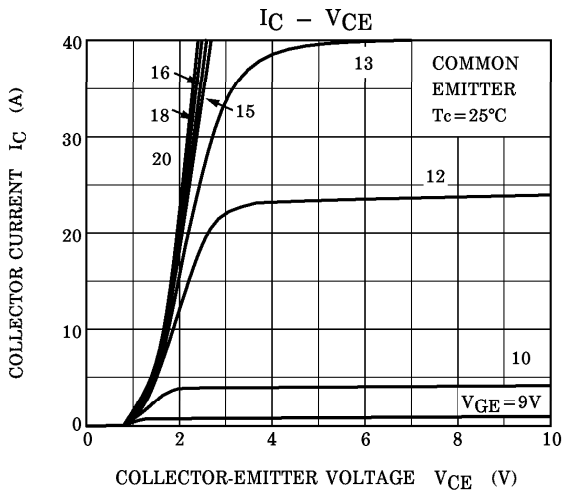

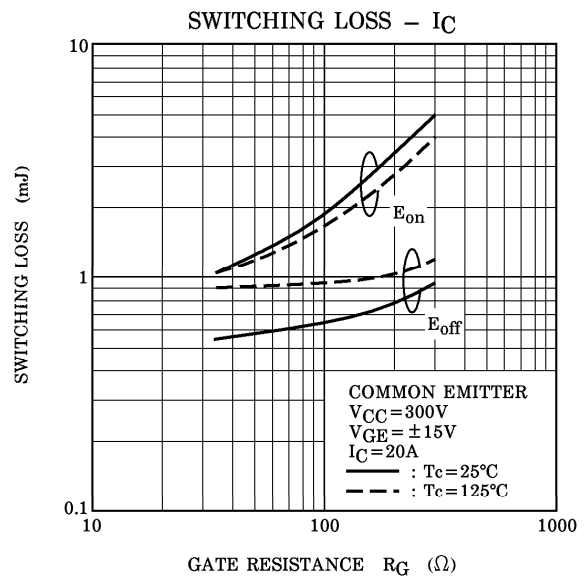
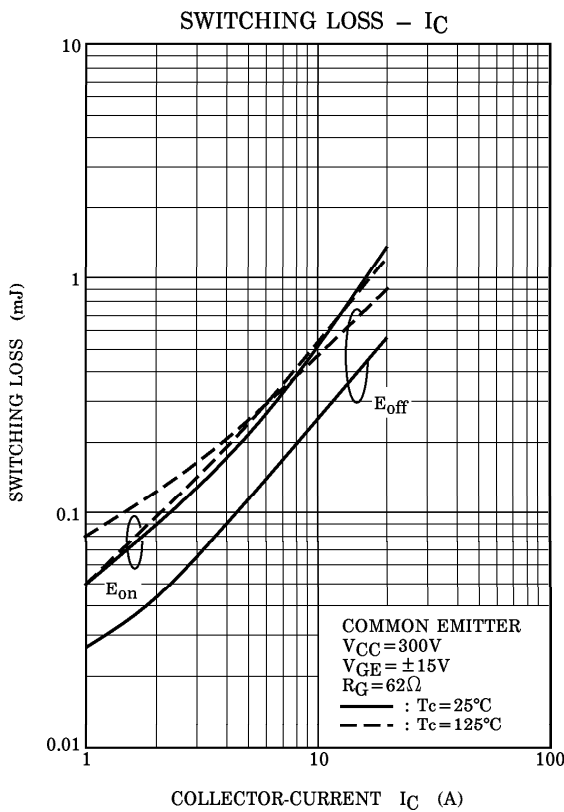
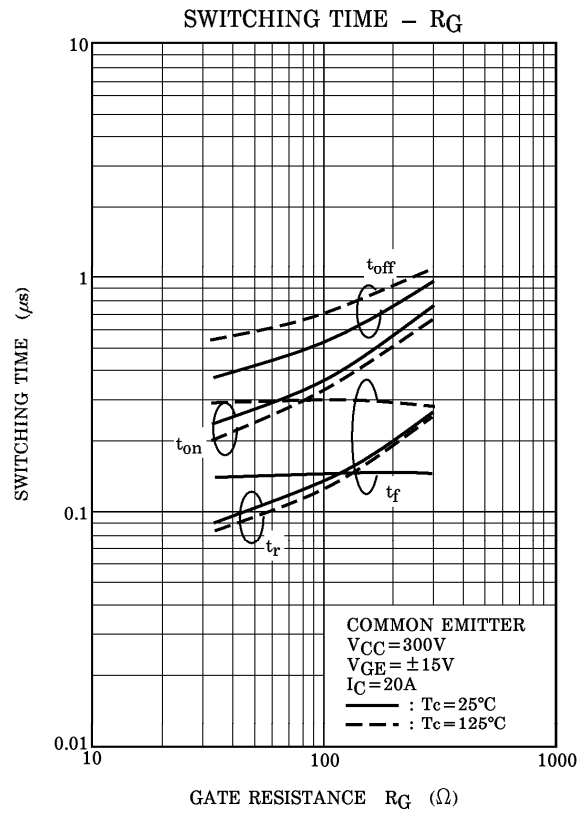
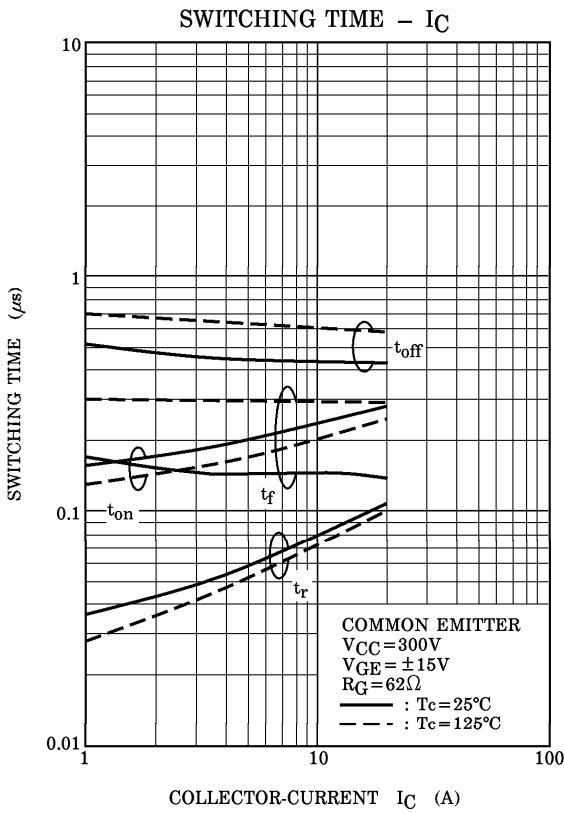

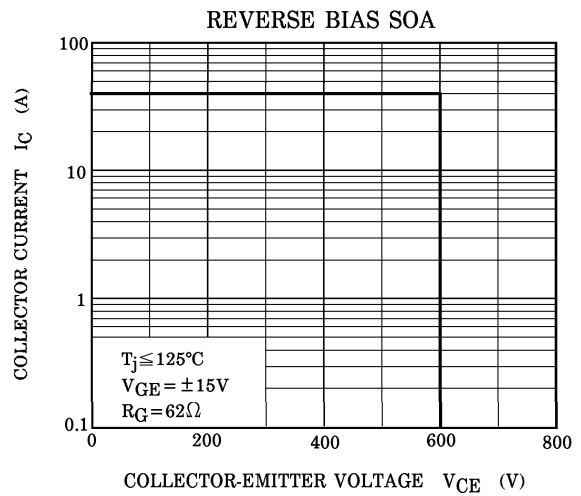
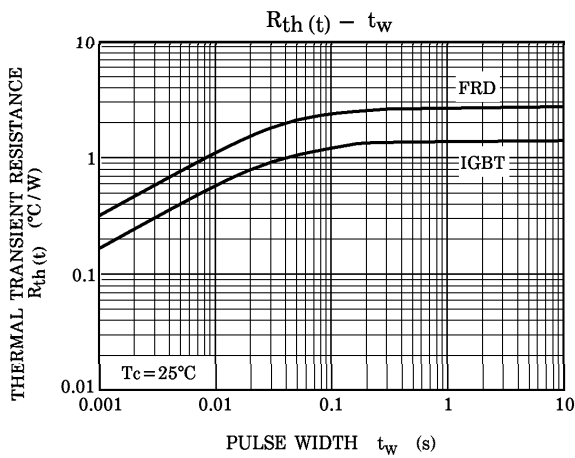
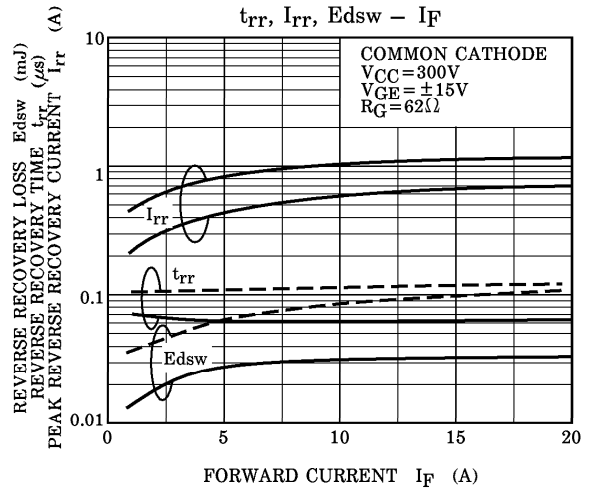
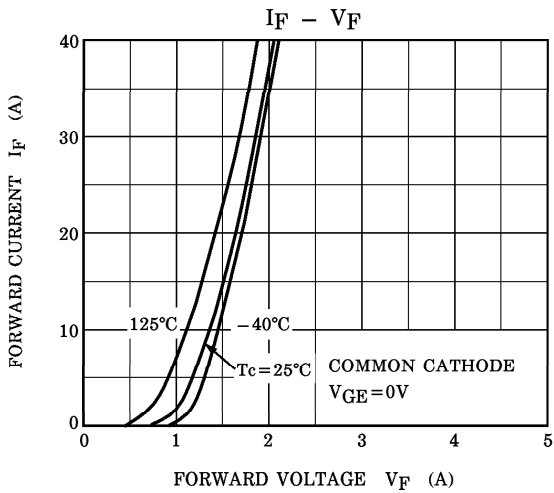
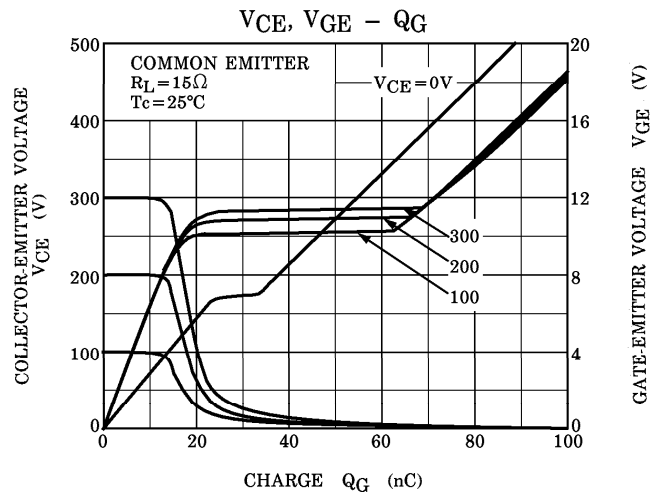
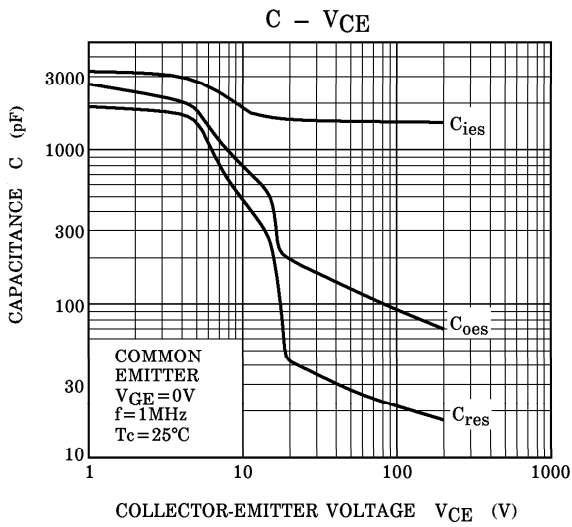

b. Converter stage

