

# High Power Diode Modules

$I_{FRSM} = 2x\ 350\ A$   
 $I_{FAVM} = 2x\ 224\ A$   
 $V_{RRM} = 1400-2200\ V$

$V_{RSM}$ V	$V_{RRM}$ V	Type
1500	1400	MDD 200-14N1
1700	1600	MDD 200-16N1
1900	1800	MDD 200-18N1
2300	2200	MDD 200-22N1

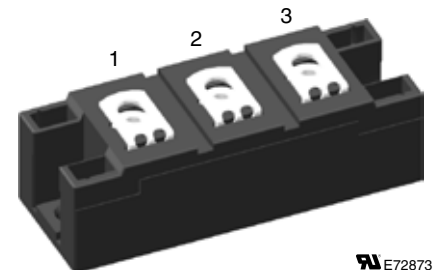
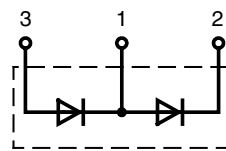

E72873

Symbol	Conditions	Maximum Ratings	
$I_{FRMS}$	$T_{VJ} = T_{VJM}$	350	A
$I_{FAVM}$	$T_C = 100^\circ C$ ; 180° sine	224	A
$I_{FSM}$	$T_{VJ} = 45^\circ C$ ; $t = 10\ ms$ (50 Hz)	10500	A
	$V_R = 0$ ; $t = 8.3\ ms$ (60 Hz)	11200	A
	$T_{VJ} = T_{VJM}$ ; $t = 10\ ms$ (50 Hz)	9100	A
	$V_R = 0$ ; $t = 8.3\ ms$ (60 Hz)	9700	A
$I^2t$	$T_{VJ} = 45^\circ C$ ; $t = 10\ ms$ (50 Hz)	551000	A <sup>2</sup> s
	$V_R = 0$ ; $t = 8.3\ ms$ (60 Hz)	527000	A <sup>2</sup> s
	$T_{VJ} = T_{VJM}$ ; $t = 10\ ms$ (50 Hz)	414000	A <sup>2</sup> s
	$V_R = 0$ ; $t = 8.3\ ms$ (60 Hz)	395000	A <sup>2</sup> s
$T_{VJ}$		-40...+150	°C
$T_{VJM}$		150	°C
$T_{stg}$		-40...+125	°C
$V_{ISOL}$	50/60 Hz, RMS $t = 1\ min$	3000	V~
	$I_{ISOL} \leq 1\ mA$ $t = 1\ s$	3600	V~
$M_d$	Mounting torque (M6)	2.25 - 2.75	Nm
	Terminal connection torque (M6)	4.5 - 5.5	Nm
Weight	Typical including screws	120	g

## Features

- International standard package
- Direct copper bonded  $Al_2O_3$  ceramic with copper base plate
- Planar passivated chips
- Isolation voltage 3600 V~

## Applications

- Supplies for DC power equipment
- DC supply for PWM inverter
- Field supply for DC motors
- Battery DC power supplies

## Advantages

- Space and weight savings
- Simple mounting
- Improved temperature and power cycling
- Reduced protection circuits

## Dimensions in mm (1 mm = 0.0394")

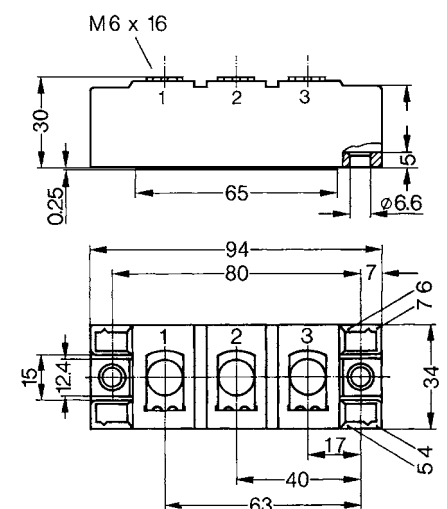

Symbol	Conditions	Characteristics Values	
$I_{RRM}$	$V_R = V_{RRM}$ ; $T_{VJ} = T_{VJM}$	20	mA
$V_F$	$I_F = 300\ A$ ; $T_{VJ} = 25^\circ C$	1.3	V
$V_{T0}$	For power-loss calculations only	0.8	V
$r_t$	$T_{VJ} = T_{VJM}$	0.6	mΩ
$R_{thJC}$	per diode; DC current	0.130	K/W
	per module	0.065	K/W
$R_{thJK}$	per diode; DC current	0.230	K/W
	per module	0.115	K/W
$Q_S$	$T_{VJ} = 125^\circ C$ ; $I_F = 300\ A$ ; $-di/dt = 50\ A/\mu s$	625	μC
$I_{RM}$		275	A
$d_s$	Creeping distance on surface	12.7	mm
$d_A$	Creepage distance in air	9.6	mm
$a$	Maximum allowable acceleration	50	m/s <sup>2</sup>

Data according to IEC 60747 and refer to a single diode unless otherwise stated.

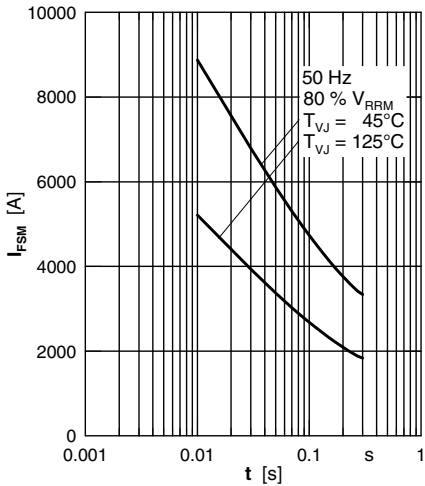

Fig. 1 Surge overload current  $I_{FSM}$ : Crest value, t: duration

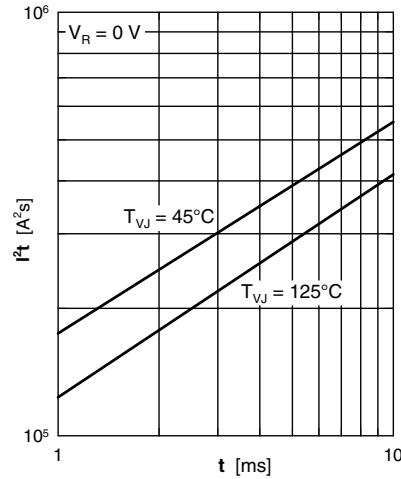

Fig. 2  $I^2t$  versus time (1-10 ms)

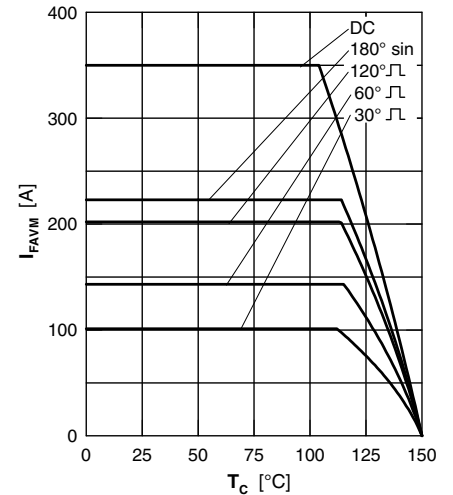

Fig. 3 Maximum forward current at case temperature

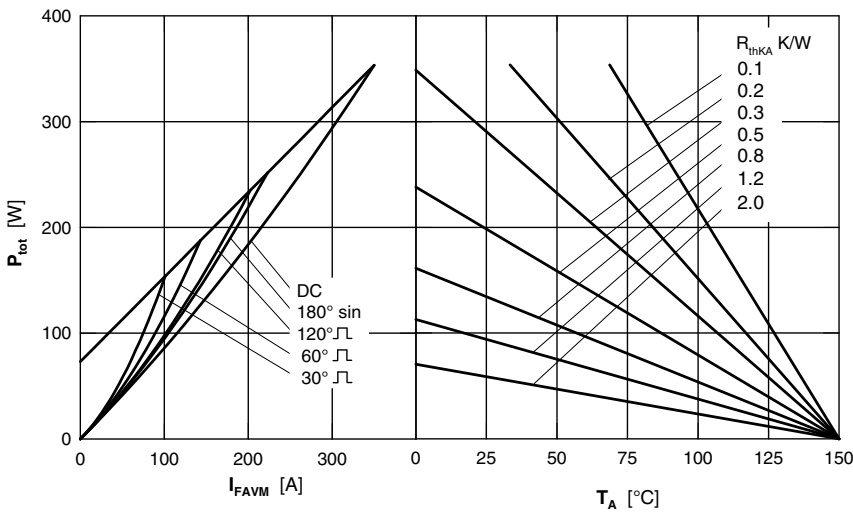

Fig. 4 Power dissipation versus forward current and ambient temperature (per diode)

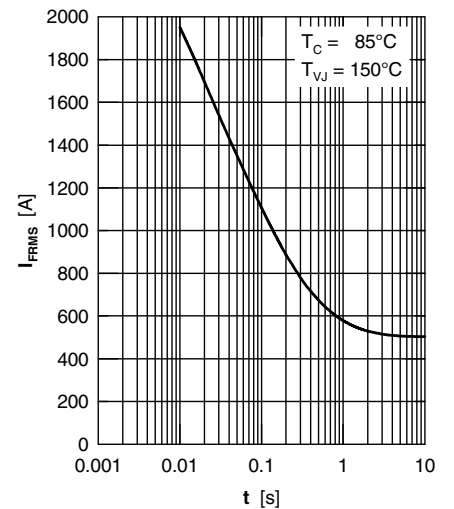

Fig. 5 Rated RMS current versus time (360° conduction)

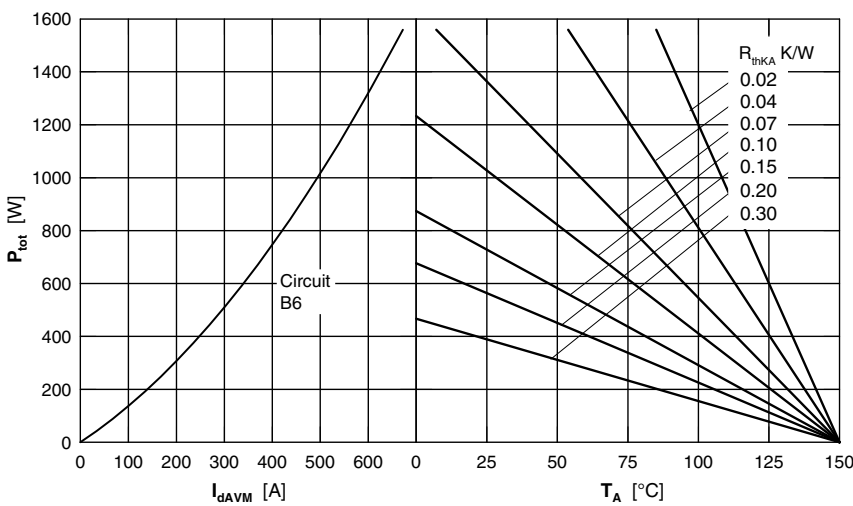

Fig. 6 Three phase rectifier bridge: Power dissipation versus direct output current and ambient temperature

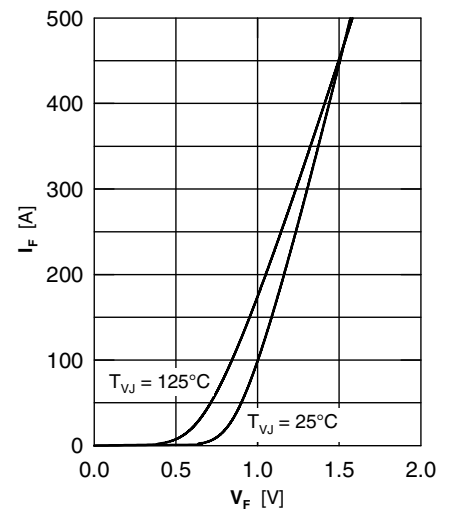

Fig. 7 Forward current versus voltage drop

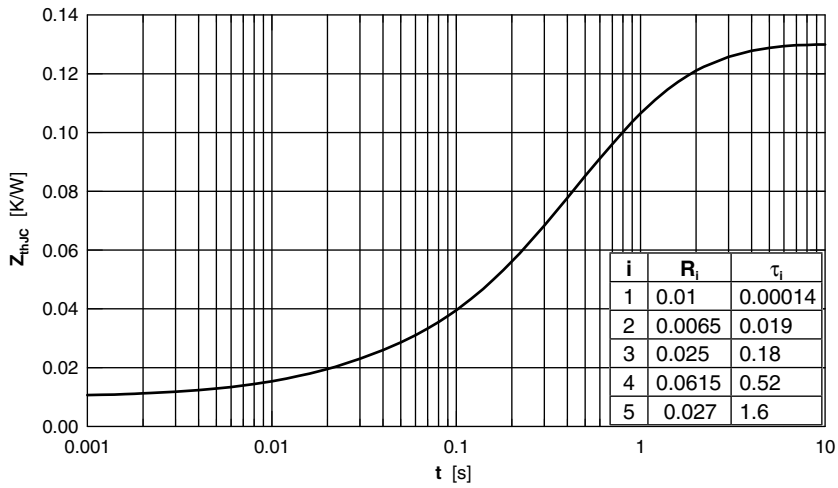

Fig. 8 Transient thermal impedance junction to case