

IGBT-Wechselrichter / IGBT-inverter

Höchstzulässige Werte / maximum rated values

Kollektor-Emitter-Sperrspannung collector-emitter voltage	$T_{vj} = 25^{\circ}\text{C}$	V_{CES}	1200	V
Kollektor-Dauergleichstrom DC-collector current	$T_C = 80^{\circ}\text{C}, T_{vj} = 150^{\circ}\text{C}$ $T_C = 25^{\circ}\text{C}, T_{vj} = 150^{\circ}\text{C}$	$I_{C\text{ nom}}$ I_C	200 295	A A
Periodischer Kollektor Spitzenstrom repetitive peak collector current	$t_p = 1\text{ ms}, T_C = 80^{\circ}\text{C}$	I_{CRM}	400	A
Gesamt-Verlustleistung total power dissipation	$T_C = 25^{\circ}\text{C}, T_{vj} = 150^{\circ}\text{C}$	P_{tot}	1050	W
Gate-Emitter-Spitzenspannung gate-emitter peak voltage		V_{GES}	+/-20	V

Charakteristische Werte / characteristic values

			min.	typ.	max.		
Kollektor-Emitter Sättigungsspannung collector-emitter saturation voltage	$I_C = 200\text{ A}, V_{GE} = 15\text{ V}$ $I_C = 200\text{ A}, V_{GE} = 15\text{ V}$	$T_{vj} = 25^{\circ}\text{C}$ $T_{vj} = 125^{\circ}\text{C}$	$V_{CE\text{ sat}}$	1,70 2,00	2,15	V V	
Gate-Schwellenspannung gate threshold voltage	$I_C = 8,00\text{ mA}, V_{CE} = V_{GE}, T_{vj} = 25^{\circ}\text{C}$		V_{GEth}	5,0	5,8	6,5	V
Gateladung gate charge	$V_{GE} = -15\text{ V} \dots +15\text{ V}$		Q_G	1,90			μC
Interner Gatewiderstand internal gate resistor	$T_{vj} = 25^{\circ}\text{C}$		R_{Gint}	3,8			Ω
Eingangskapazität input capacitance	$f = 1\text{ MHz}, T_{vj} = 25^{\circ}\text{C}, V_{CE} = 25\text{ V}, V_{GE} = 0\text{ V}$		C_{ies}	14,0			nF
Rückwirkungskapazität reverse transfer capacitance	$f = 1\text{ MHz}, T_{vj} = 25^{\circ}\text{C}, V_{CE} = 25\text{ V}, V_{GE} = 0\text{ V}$		C_{res}	0,50			nF
Kollektor-Emitter Reststrom collector-emitter cut-off current	$V_{CE} = 1200\text{ V}, V_{GE} = 0\text{ V}, T_{vj} = 25^{\circ}\text{C}$		I_{CES}		5,0		mA
Gate-Emitter Reststrom gate-emitter leakage current	$V_{CE} = 0\text{ V}, V_{GE} = 20\text{ V}, T_{vj} = 25^{\circ}\text{C}$		I_{GES}		400		nA
Einschaltverzögerungszeit (ind. Last) turn-on delay time (inductive load)	$I_C = 200\text{ A}, V_{CE} = 600\text{ V}$ $V_{GE} = \pm 15\text{ V}$ $R_{Gon} = 3,6\ \Omega$	$T_{vj} = 25^{\circ}\text{C}$ $T_{vj} = 125^{\circ}\text{C}$	$t_{d\text{ on}}$	0,25 0,30			μs μs
Anstiegszeit (induktive Last) rise time (inductive load)	$I_C = 200\text{ A}, V_{CE} = 600\text{ V}$ $V_{GE} = \pm 15\text{ V}$ $R_{Gon} = 3,6\ \Omega$	$T_{vj} = 25^{\circ}\text{C}$ $T_{vj} = 125^{\circ}\text{C}$	t_r	0,09 0,10			μs μs
Abschaltverzögerungszeit (ind. Last) turn-off delay time (inductive load)	$I_C = 200\text{ A}, V_{CE} = 600\text{ V}$ $V_{GE} = \pm 15\text{ V}$ $R_{Goff} = 3,6\ \Omega$	$T_{vj} = 25^{\circ}\text{C}$ $T_{vj} = 125^{\circ}\text{C}$	$t_{d\text{ off}}$	0,55 0,65			μs μs
Fallzeit (induktive Last) fall time (inductive load)	$I_C = 200\text{ A}, V_{CE} = 600\text{ V}$ $V_{GE} = \pm 15\text{ V}$ $R_{Goff} = 3,6\ \Omega$	$T_{vj} = 25^{\circ}\text{C}$ $T_{vj} = 125^{\circ}\text{C}$	t_f	0,13 0,18			μs μs
Einschaltverlustenergie pro Puls turn-on energy loss per pulse	$I_C = 200\text{ A}, V_{CE} = 600\text{ V}$ $V_{GE} = \pm 15\text{ V}, L_s = 80\text{ nH}$ $R_{Gon} = 3,6\ \Omega$	$T_{vj} = 25^{\circ}\text{C}$ $T_{vj} = 125^{\circ}\text{C}$	E_{on}	15,0			mJ mJ
Abschaltverlustenergie pro Puls turn-off energy loss per pulse	$I_C = 200\text{ A}, V_{CE} = 600\text{ V}$ $V_{GE} = \pm 15\text{ V}, L_s = 80\text{ nH}$ $R_{Goff} = 3,6\ \Omega$	$T_{vj} = 25^{\circ}\text{C}$ $T_{vj} = 125^{\circ}\text{C}$	E_{off}	35,0			mJ mJ
Kurzschlußverhalten SC data	$t_p \leq 10\ \mu\text{s}, V_{GE} \leq 15\text{ V}$ $T_{vj} = 125^{\circ}\text{C}, V_{CC} = 900\text{ V}, V_{CEmax} = V_{CES} - L_s \cdot di/dt$		I_{SC}	800			A
Innerer Wärmewiderstand thermal resistance, junction to case	pro IGBT per IGBT		R_{thJC}		0,12		K/W

prepared by: Mark Münzer	date of publication: 2004-4-8
approved by: Wilhelm Rusche	revision: 3.1

Diode-Wechselrichter / diode-inverter
Höchstzulässige Werte / maximum rated values

Periodische Spitzensperrspannung repetitive peak reverse voltage	$T_{vj} = 25^{\circ}\text{C}$	V_{RRM}	1200	V
Dauergleichstrom DC forward current		I_F	200	A
Periodischer Spitzenstrom repetitive peak forward current	$t_p = 1 \text{ ms}$	I_{FRM}	400	A
Grenzlastintegral I^2t - value	$V_R = 0 \text{ V}, t_p = 10 \text{ ms}, T_{vj} = 125^{\circ}\text{C}$	I^2t	7800	A^2s

Charakteristische Werte / characteristic values

			min.	typ.	max.	
Durchlassspannung forward voltage	$I_F = 200 \text{ A}, V_{GE} = 0 \text{ V}$ $I_F = 200 \text{ A}, V_{GE} = 0 \text{ V}$	$T_{vj} = 25^{\circ}\text{C}$ $T_{vj} = 125^{\circ}\text{C}$	V_F	1,65 1,65	2,15	V V
Rückstromspitze peak reverse recovery current	$I_F = 200 \text{ A}, -di_F/dt = 2000 \text{ A}/\mu\text{s}$ $V_R = 600 \text{ V}$ $V_{GE} = -15 \text{ V}$	$T_{vj} = 25^{\circ}\text{C}$ $T_{vj} = 125^{\circ}\text{C}$	I_{RM}	150 190		A A
Sperrverzögerungsladung recovered charge	$I_F = 200 \text{ A}, -di_F/dt = 2000 \text{ A}/\mu\text{s}$ $V_R = 600 \text{ V}$ $V_{GE} = -15 \text{ V}$	$T_{vj} = 25^{\circ}\text{C}$ $T_{vj} = 125^{\circ}\text{C}$	Q_r	20,0 36,0		μC μC
Abschaltenergie pro Puls reverse recovery energy	$I_F = 200 \text{ A}, -di_F/dt = 2000 \text{ A}/\mu\text{s}$ $V_R = 600 \text{ V}$ $V_{GE} = -15 \text{ V}$	$T_{vj} = 25^{\circ}\text{C}$ $T_{vj} = 125^{\circ}\text{C}$	E_{rec}	9,00 17,0		mJ mJ
Innerer Wärmewiderstand thermal resistance, junction to case	pro Diode per diode		R_{thJC}		0,20	KW

prepared by: Mark Münzer	date of publication: 2004-4-8
approved by: Wilhelm Rusche	revision: 3.1

Modul / module

Isolations-Prüfspannung insulation test voltage	RMS, f = 50 Hz, t = 1 min.	V _{ISO}	2,5		kV
Material Modulgrundplatte material of module baseplate			Cu		
Material für innere Isolation material for internal insulation			Al ₂ O ₃		
Kriechstrecke creepage distance	Kontakt - Kühlkörper / terminal to heatsink Kontakt - Kontakt / terminal to terminal		20,0		mm
Luftstrecke clearance distance	Kontakt - Kühlkörper / terminal to heatsink Kontakt - Kontakt / terminal to terminal		11,0		mm
Vergleichszahl der Kriechwegbildung comparative tracking index		CTI	> 425		
			min.	typ.	max.
Übergangs-Wärmewiderstand thermal resistance, case to heatsink	pro Modul / per module $\lambda_{\text{Paste}} = 1 \text{ W}/(\text{m}\cdot\text{K}) / \lambda_{\text{grease}} = 1 \text{ W}/(\text{m}\cdot\text{K})$	R _{thCH}		0,01	K/W
Modulinduktivität stray inductance module		L _{sCE}		20	nH
Moduleitungswiderstand, Anschlüsse - Chip module lead resistance, terminals - chip	T _C = 25°C, pro Schalter / per switch	R _{CC'+EE'}		0,70	mΩ
Höchstzulässige Sperrschichttemperatur maximum junction temperature	Wechselrichter / inverter	T _{vj max}			150 °C
Temperatur im Schaltbetrieb temperature under switching conditions	Wechselrichter / inverter	T _{vj op}	-40		125 °C
Lagertemperatur storage temperature		T _{stg}	-40		125 °C
Anzugsdrehmoment f. mech. Befestigung mounting torque	Schraube / screw M6	M	3,00	-	6,00 Nm
Anzugsdrehmoment f. elektr. Anschlüsse terminal connection torque	Schraube / screw M6	M	2,5	-	5,0 Nm
Gewicht weight		G		340	g

Mit dieser technischen Information werden Halbleiterbauelemente spezifiziert, jedoch keine Eigenschaften zugesichert. Sie gilt in Verbindung mit den zugehörigen technischen Erläuterungen.

This technical information specifies semiconductor devices but guarantees no characteristics. It is valid with the appropriate technical explanations.

prepared by: Mark Münzer	date of publication: 2004-4-8
approved by: Wilhelm Rusche	revision: 3.1

Ausgangskennlinie IGBT-Wechselr. (typisch)
output characteristic IGBT-inverter (typical)
 $I_c = f(V_{CE})$
 $V_{GE} = 15\text{ V}$

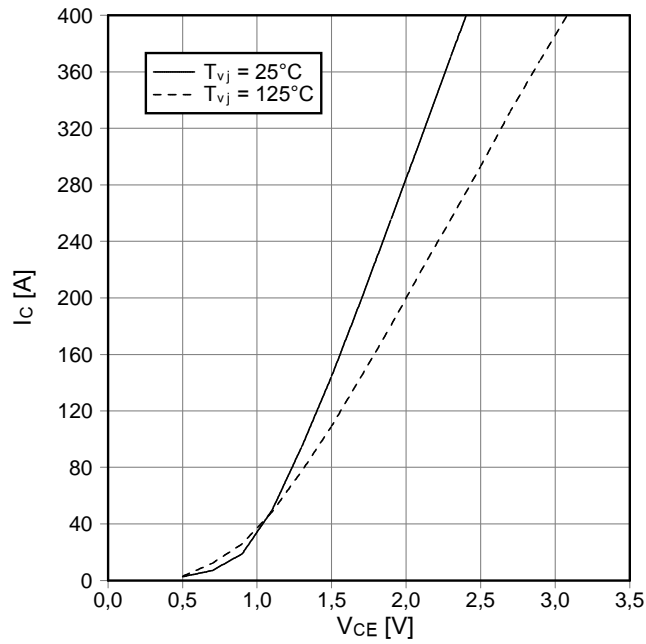

Ausgangskennlinienfeld IGBT-Wechselr. (typisch)
output characteristic IGBT-inverter (typical)
 $I_c = f(V_{CE})$
 $T_{vj} = 125^\circ\text{C}$

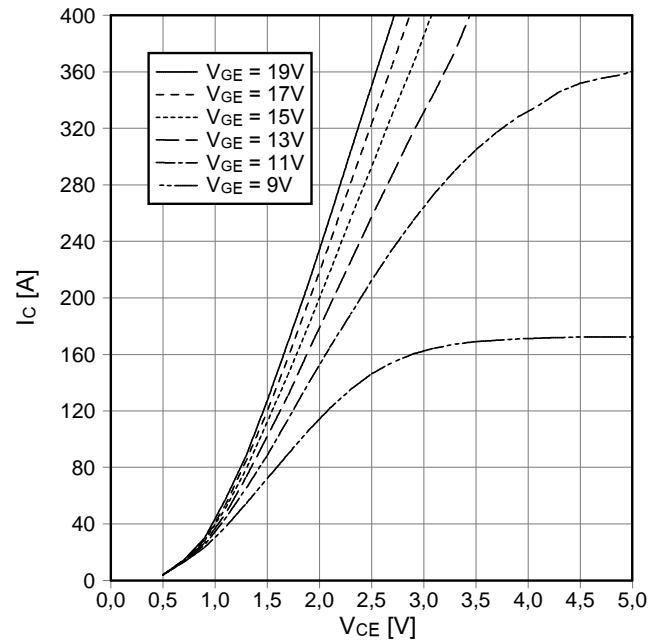

Übertragungscharakteristik IGBT-Wechselr. (typisch)
transfer characteristic IGBT-inverter (typical)
 $I_c = f(V_{GE})$
 $V_{CE} = 20\text{ V}$

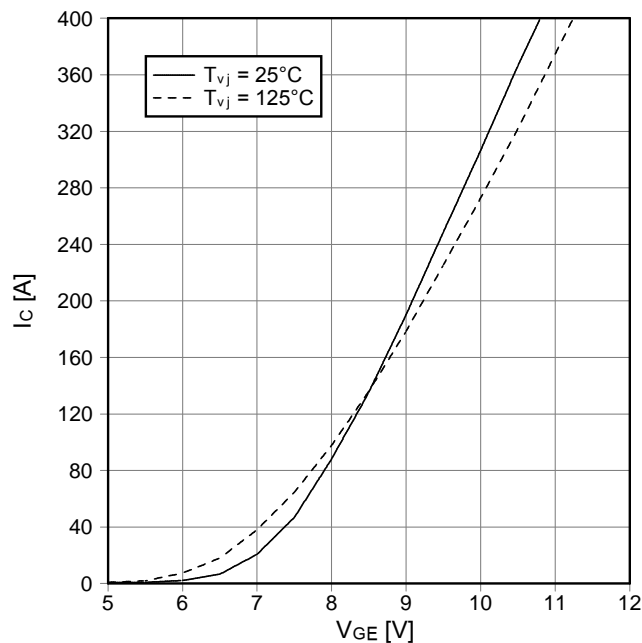

Schaltverluste IGBT-Wechselr. (typisch)
switching losses IGBT-inverter (typical)
 $E_{on} = f(I_c), E_{off} = f(I_c)$
 $V_{GE} = \pm 15\text{ V}, R_{Gon} = 3,6\ \Omega, R_{Goff} = 3,6\ \Omega, V_{CE} = 600\text{ V}$

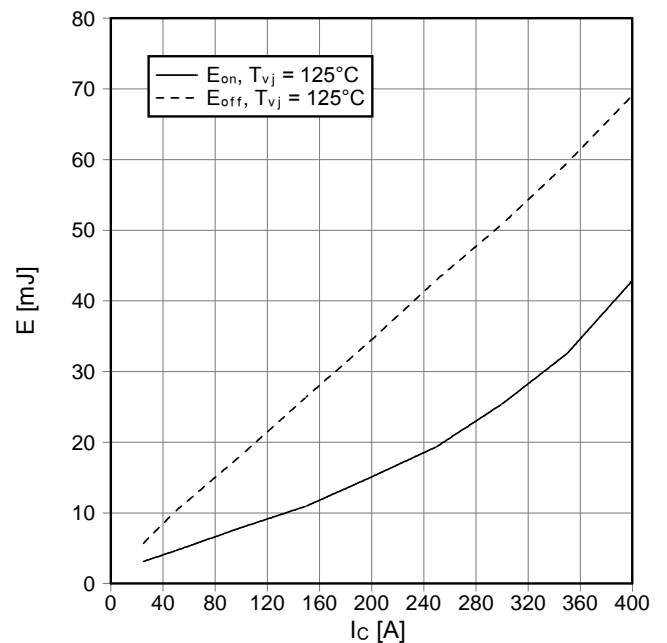

prepared by: Mark Münzer	date of publication: 2004-4-8
approved by: Wilhelm Rusche	revision: 3.1

Schaltverluste IGBT-Wechsel. (typisch)
switching losses IGBT-inverter (typical)
 $E_{on} = f(R_G)$, $E_{off} = f(R_G)$
 $V_{GE} = \pm 15\text{ V}$, $I_C = 200\text{ A}$, $V_{CE} = 600\text{ V}$

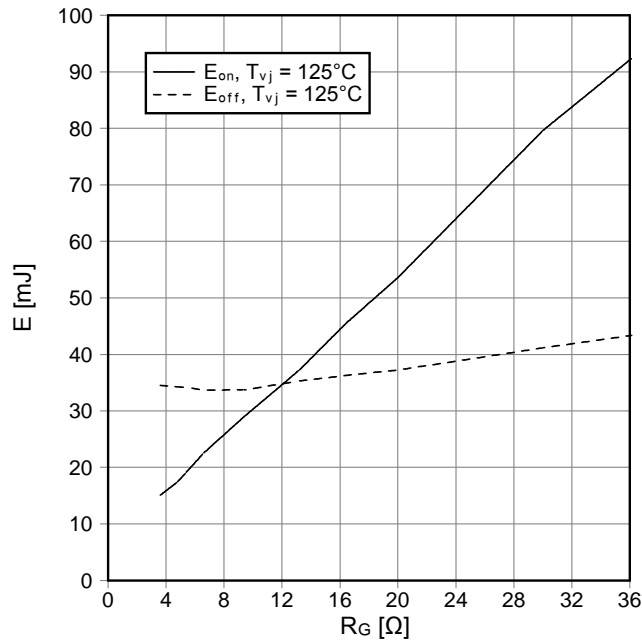

Transienter Wärmewiderstand IGBT-Wechsel.
transient thermal impedance IGBT-inverter
 $Z_{thJC} = f(t)$

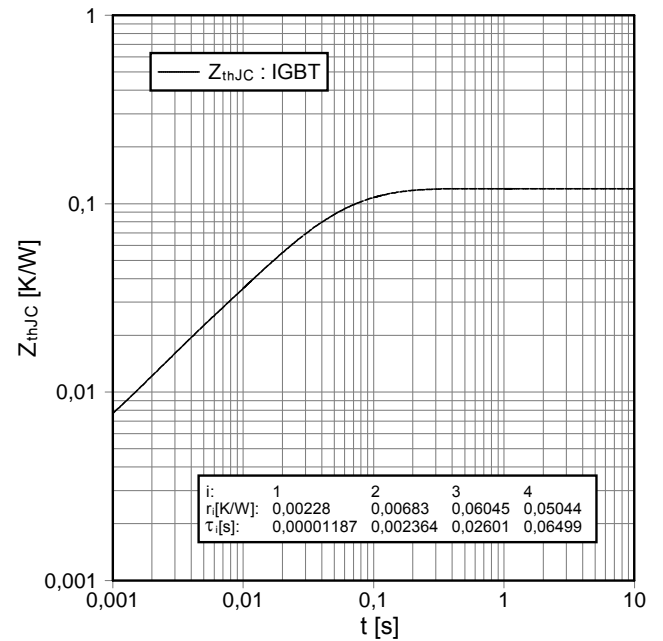

Sicherer Rückwärts-Arbeitsbereich IGBT-Wr. (RBSOA)
reverse bias safe operating area IGBT-inv. (RBSOA)
 $I_C = f(V_{CE})$
 $V_{GE} = \pm 15\text{ V}$, $R_{Goff} = 3,6\ \Omega$, $T_{vj} = 125^\circ\text{C}$

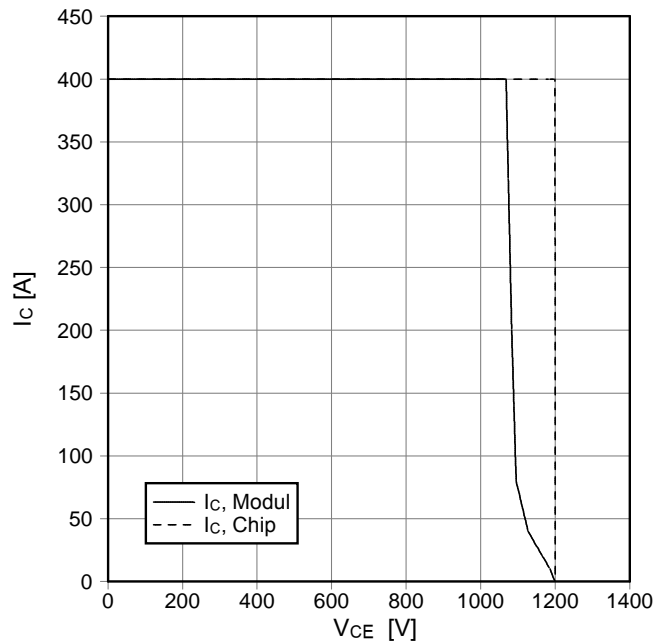

Durchlaßkennlinie der Diode-Wechsel. (typisch)
forward characteristic of diode-inverter (typical)
 $I_F = f(V_F)$

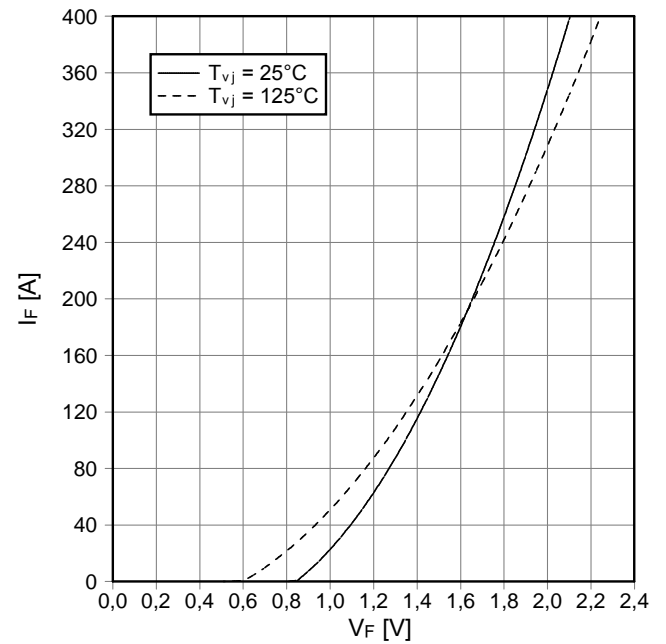

prepared by: Mark Münzer	date of publication: 2004-4-8
approved by: Wilhelm Rusche	revision: 3.1

Schaltverluste Diode-Wechselr. (typisch)
switching losses diode-inverter (typical)

$E_{rec} = f(I_F)$
 $R_{Gon} = 3,6 \Omega, V_{CE} = 600 V$

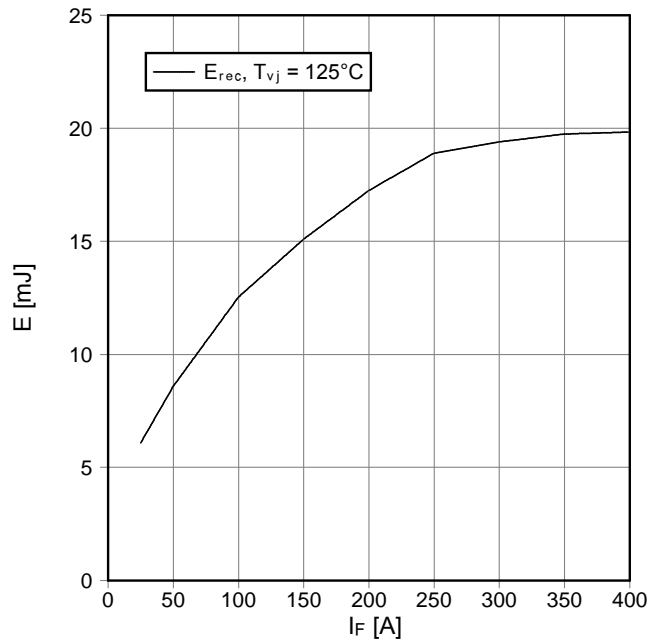

Schaltverluste Diode-Wechselr. (typisch)
switching losses diode-inverter (typical)

$E_{rec} = f(R_G)$
 $I_F = 200 A, V_{CE} = 600 V$

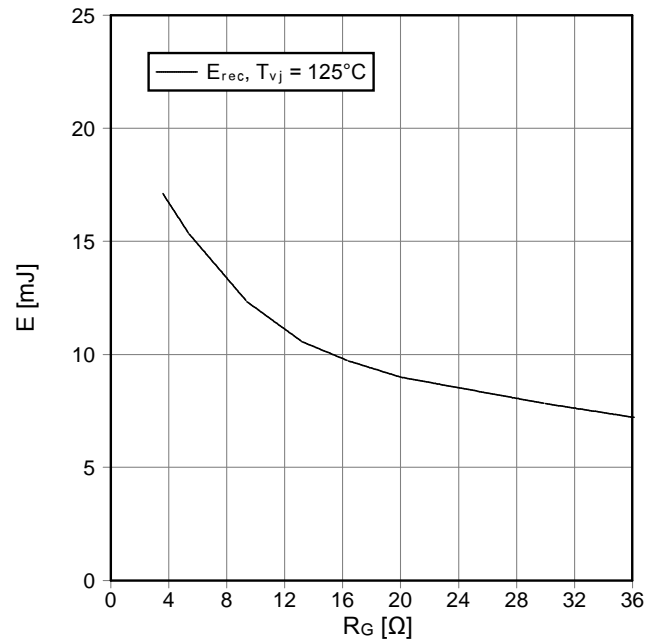

Transienter Wärmewiderstand Diode-Wechselr.
transient thermal impedance diode-inverter

$Z_{thJC} = f(t)$

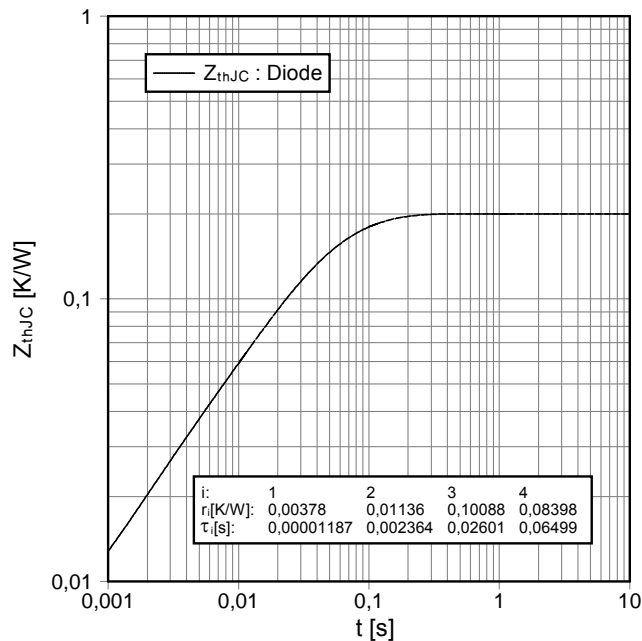

i:	1	2	3	4
r_i [K/W]:	0,00378	0,01136	0,10088	0,08398
τ_i [s]:	0,00001187	0,002364	0,02601	0,06499

prepared by: Mark Münzer	date of publication: 2004-4-8
approved by: Wilhelm Rusche	revision: 3.1

Schaltplan / circuit diagram

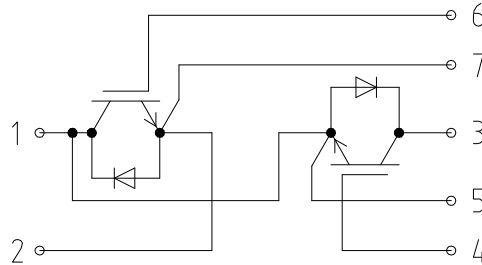

Gehäuseabmessungen / package outlines

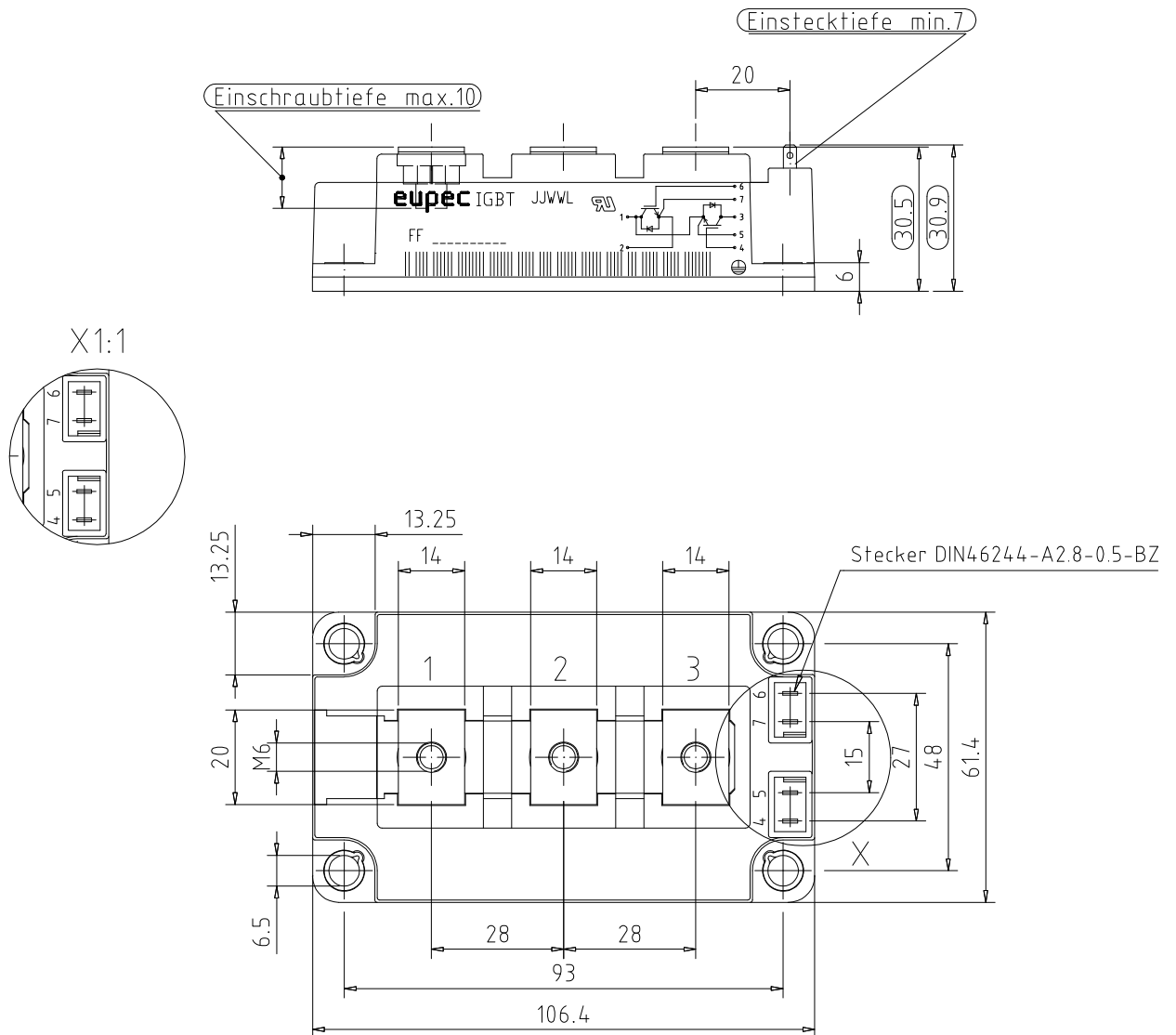

prepared by: Mark Münzer	date of publication: 2004-4-8
approved by: Wilhelm Rusche	revision: 3.1