

# THREE PHASE DIODE+THYRISTOR

# DFA100BA80/160

**SanRex** Power Module, DFA100BA, is complex isolated module which is designed for rash current circuit.

It contains six diodes connected in a three phase bridge configuration, and a thyristor connected to a direct current line.

- This Module is designed very compactly. Because diode module and thyristor put together.
- This Module is also isolated type between electorode terminal and mounting base. So you can put this Module and other one together in a same fin.

**(Application)**

- Inverter for AC or DC motor control, Current stabilized power supply, Switching power supply.

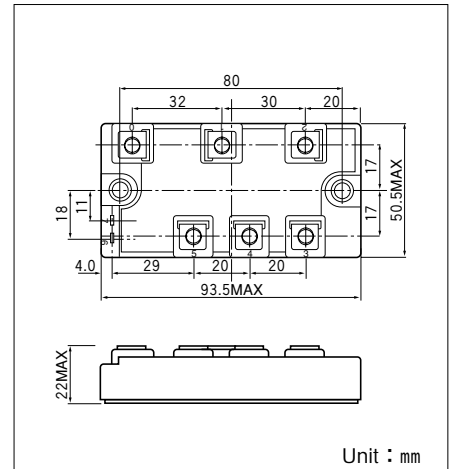
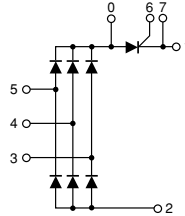

**● DIODE**

**■ Maximum Ratings**

(T<sub>j</sub>=25°C unless otherwise specified)

Symbol	Item	Ratings		Unit
		DFA100BA80	DFA100BA160	
V <sub>RRM</sub>	Repetitive Peak Reverse Voltage	800	1600	V
V <sub>RSM</sub>	Non-Repetitive Peak Reverse Voltage	960	1700	V

Symbol	Item	Conditions	Ratings	Unit	
I <sub>D</sub>	Output Current (D.C.)	Three phase full wave, T <sub>c</sub> =98°C	100	A	
I <sub>FSM</sub>	Surge forward current	1 cycle, 50/60Hz, peak value, non-repetitive	1186/1300	A	
T <sub>j</sub>	Operating Junction Temperature		-40 to +150	°C	
T <sub>stg</sub>	Storage Temperature		-40 to +125	°C	
V <sub>ISO</sub>	Isolation Breakdown Voltage (R.M.S.)	A.C. 1minute	2500	V	
	Mounting Torque	Mounting (M5)	Recommended Value 1.5-2.5 (15-25)	2.7 (28)	N·m (kgf·cm)
		Terminal (M5)	Recommended Value 1.5-2.5 (15-25)	2.7 (28)	
	Mass	Typical Value	150	g	

**■ Electrical Characteristics**

Symbol	Item	Conditions	Ratings	Unit
I <sub>RRM</sub>	Repetitive Peak Reverse Current,max.	T <sub>j</sub> =150°C, V <sub>R</sub> =V <sub>RRM</sub>	12	mA
V <sub>FM</sub>	Forward Voltage Drop,max.	T <sub>j</sub> =25°C, I <sub>F</sub> =100A, Inst. measurement	1.30	V
R <sub>th(j-c)</sub>	Thermal Impedance, max.	Junction to Case (TOTAL)	0.20	°C/W
R <sub>th(c-f)</sub>	Thermal Impedance, max.	Case to Fin	0.10	°C/W

# DFA100BA80/160

## ● THYRISTOR

### ■ Maximum Ratings

(T<sub>j</sub>=25°C unless otherwise specified)

Symbol	Item	Ratings		Unit
		DFA100BA80	DFA100BA160	
V <sub>RRM</sub>	Repetitive Peak Reverse Voltage	800	1600	V
V <sub>RSM</sub>	Non-Repetitive Peak Reverse Voltage	960	1700	V
V <sub>DRM</sub>	Repetitive Peak off-State Voltage	800	1600	V

Symbol	Item	Conditions	Ratings	Unit	
I <sub>T(AV)</sub>	Average On-State Current	Singl phase half wave. 180° conduction, T <sub>c</sub> =92°C	100	A	
I <sub>TSM</sub>	Surge On-State Current	1 cycle, 50/60Hz, peak value, non-repetitive	1186/1300	A	
I <sup>2</sup> t	I <sup>2</sup> t		7030	A <sup>2</sup> S	
di/dt	Critical Rate of Rise of On-State Current	I <sub>G</sub> =100mA, V <sub>D</sub> =1/2V <sub>DRM</sub> , di <sub>G</sub> /dt=0.1A/μs	150	A/μs	
V <sub>ISO</sub>	Isolation Breakdown Voltage (R.M.S.)	A.C. 1minute	2500	V	
T <sub>j</sub>	Operating Junction Temperature		-40 to +135	°C	
T <sub>stg</sub>	Storage Temperature		-40 to +125	°C	
	Mounting Torque	Mounting (M5)	Recommended Value 1.5-2.5 (15-25)	2.7 (28)	N·m (kgf·cm)
		Terminals (M5)	Recommended Value 1.5-2.5 (15-25)	2.7 (28)	
	Mass	Typical Value	150	g	

### ■ Electrical Characteristics

Symbol	Item	Conditions	Ratings	Unit
I <sub>DRM</sub>	Repetitive Peak Off-State Current,max.	T <sub>j</sub> =135°C, V <sub>D</sub> =V <sub>DRM</sub>	70	mA
I <sub>RRM</sub>	Repetitive Peak Reverse Current,max.	T <sub>j</sub> =135°C, V <sub>D</sub> =V <sub>RRM</sub>	70	mA
V <sub>TM</sub>	Peak On-State Voltage,max.	T <sub>j</sub> =25°C, I <sub>TM</sub> =100A, Inst. measurement	1.20	V
I <sub>GT</sub>	Gate Trigger Current,max.	V <sub>D</sub> =6V, I <sub>T</sub> =1A	70	mA
V <sub>GT</sub>	Gate Trigger Voltage,max.	V <sub>D</sub> =6V, I <sub>T</sub> =1A	3	V
dv/dt	Critical Rate of Rise of Off-State Voltage,min.	T <sub>j</sub> =125°C, V <sub>D</sub> =2/3V <sub>DRM</sub>	500	V/μs
R <sub>th(j-c)</sub>	Thermal Impedance, max.	Junction to Case	0.36	°C/W
R <sub>th(c-f)</sub>	Thermal Impedance, max.	Case to Fin	0.10	°C/W

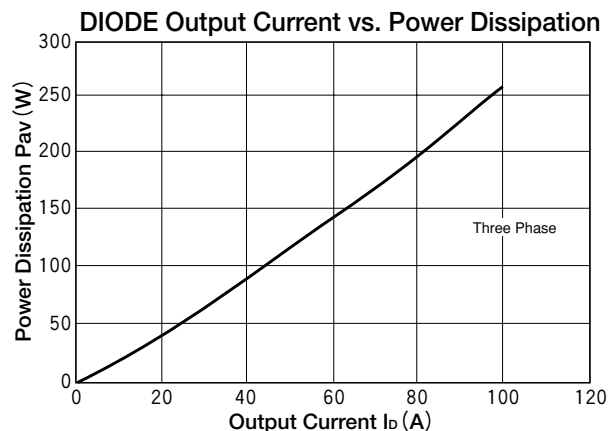
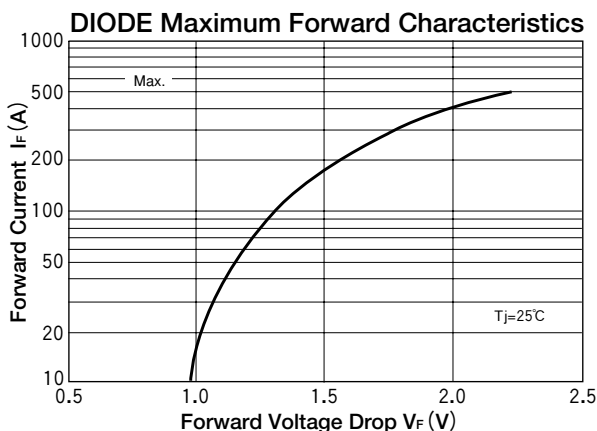

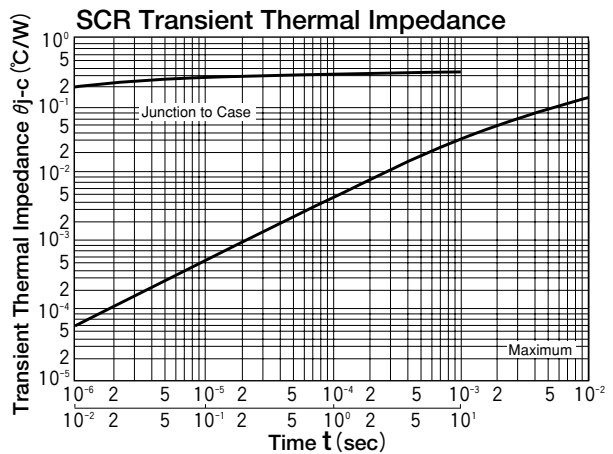
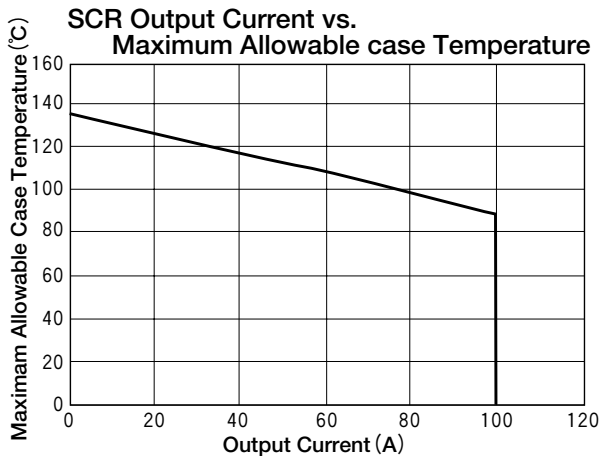
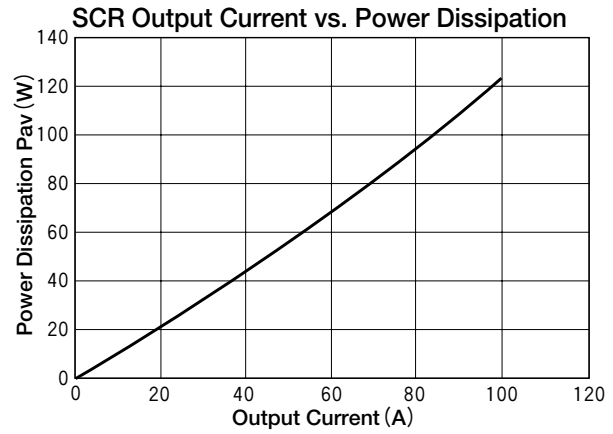
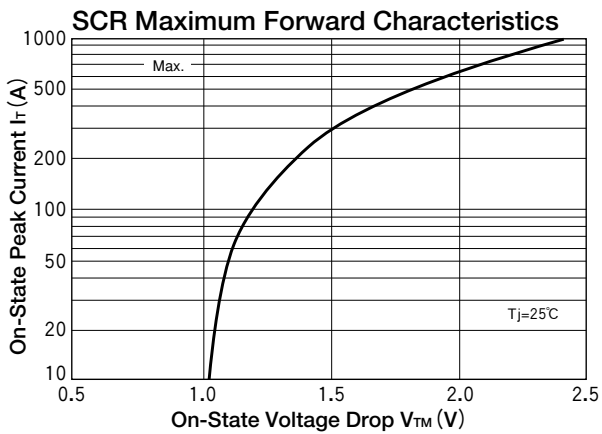
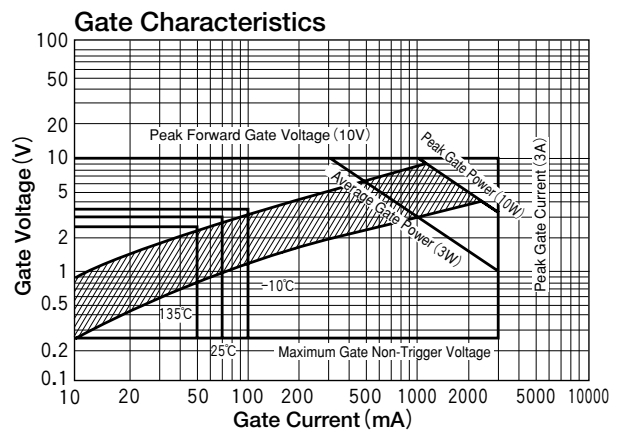
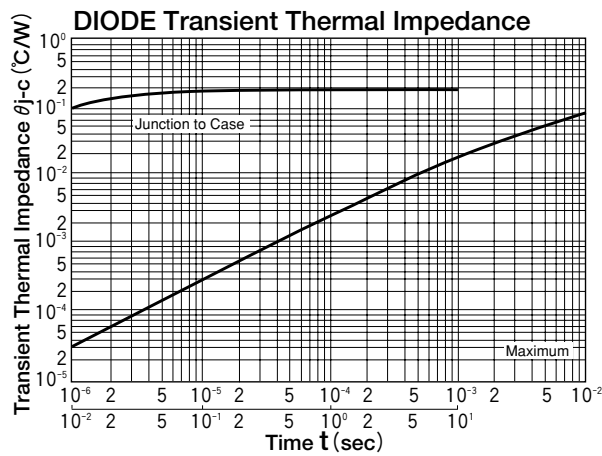
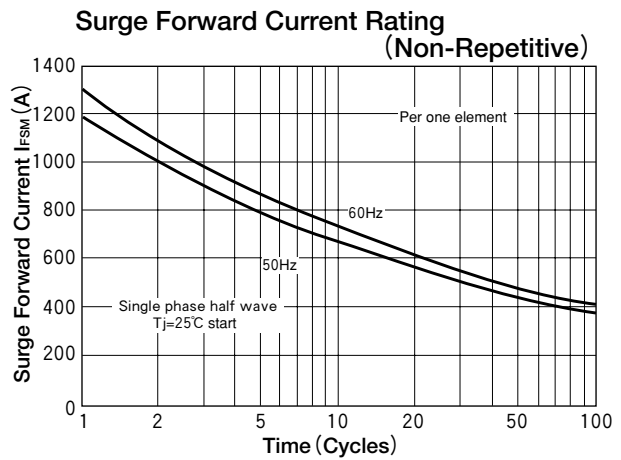
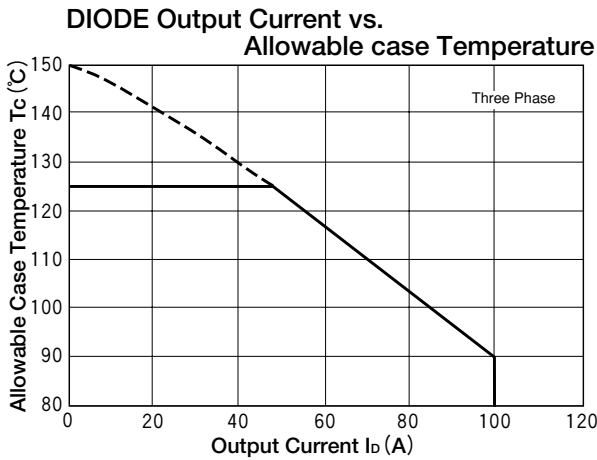

This datasheet has been download from:

[www.datasheetcatalog.com](http://www.datasheetcatalog.com)

Datasheets for electronics components.