



**CM300DY-12E**

Powerex, Inc., 200 Hillis Street, Youngwood, Pennsylvania 15697-1800 (412) 925-7272  
 Powerex, Europe, S.A. 428 Avenue G. Durand, BP107, 72003 Le Mans, France (43) 41.14.14

**Dual IGBTMOD™  
 E-Series Module  
 300 Amperes/600 Volts**

POWEREX INC

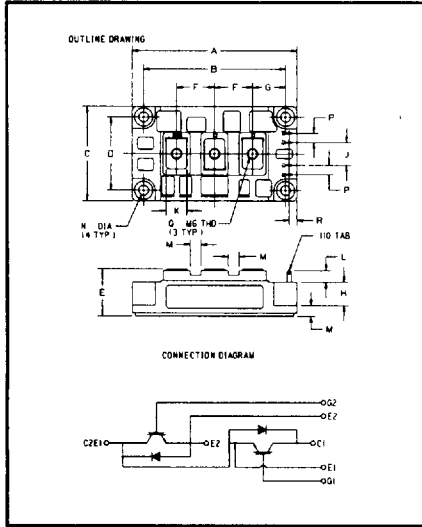

**CM300DY-12.E**  
 Outline Drawing

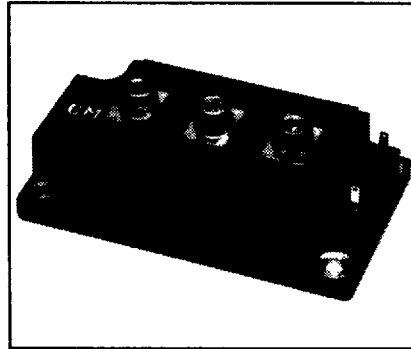

**CM300DY-12E**  
 Dual IGBTMOD™ E-Series Module  
 300 Amperes/600 Volts

Dimensions	Inches	Millimeters
A	4.25	108.0
B	3.661±0.01	93.0±0.25
C	2.44	62.0
D	1.89±0.01	48.0±0.25
E	1.22 Max.	31.0 Max.
F	0.20	5.0
G	0.98	25.0
H	0.85	21.5
J	0.59	15.2
K	0.71	18.0
L	0.59	15.0
M	0.55	14.0
N	0.28	7.0
P	0.26 Dia.	Dia. 6.5
Q	0.26	6.5
R	0.24	6.0
S	M6 Metric	M6

**Description:**

Powerex IGBTMOD™ Modules are designed for use in switching applications. Each module consists of two IGBT Transistors in a half-bridge configuration with each transistor having a reverse-connected super-fast recovery free-wheel diode. All components and interconnects are isolated from the heat sinking baseplate, offering simplified system assembly and thermal management.

**Features:**

- Low Drive Power
- Low  $V_{CE(sat)}$
- Discrete Super-Fast Recovery (150ns) Free-Wheel Diode
- High Frequency Operation (15-20kHz)
- Isolated Baseplate for Easy Heat Sinking

**Applications:**

- AC Motor Control
- Motion/Servo Control
- UPS
- Welding Power Supplies
- Laser Power Supplies

**Ordering Information:**

Example: Select the complete part module number you desire from the table below  
 -i.e. CM300DY-12E is a 600V ( $V_{CES}$ ), 300 Ampere Dual IGBTMOD™ Power Module.

Type	Current Rating Amperes	$V_{CES}$ Volts (x 50)
CM	300	12



POWEREX INC

Powerex, Inc., 200 Hillis Street, Youngwood, Pennsylvania 15697-1800 (412) 925-7272  
 Powerex, Europe, S.A. 428 Avenue G. Durand, BP107, 72003 Le Mans, France (43) 41.14.14

**CM300DY-12E**  
**Dual IGBTMOD™ E-Series Module**  
 300 Amperes/600 Volts

### Absolute Maximum Ratings, $T_j = 25\text{ }^\circ\text{C}$ unless otherwise specified

Ratings	Symbol	CM300DY-12E	Units
Junction Temperature	$T_j$	-40 to 150	$^\circ\text{C}$
Storage Temperature	$T_{stg}$	-40 to 125	$^\circ\text{C}$
Collector-Emitter Voltage (G-E SHORT)	$V_{CES}$	600	Volts
Gate-Emitter Voltage	$V_{GES}$	$\pm 20$	Volts
Collector Current	$I_C$	300	Amperes
Peak Collector Current	$I_{CM}$	600*	Amperes
Diode Forward Current	$I_{FM}$	300	Amperes
Diode Forward Surge Current	$I_{FM}$	600*	Amperes
Power Dissipation	$P_d$	1100	Watts
Max. Mounting Torque M6 Terminal Screws	-	26	in-lb
Max. Mounting Torque M6 Mounting Screws	-	26	in-lb
Module Weight (Typical)	-	400	Grams
V Isolation	$V_{RMS}$	2500	Volts

\* Pulse width and repetition rate should be such that device junction temperature does not exceed the device rating

### Static Electrical Characteristics, $T_j = 25\text{ }^\circ\text{C}$ unless otherwise specified

Characteristics	Symbol	Test Conditions	Min.	Typ.	Max.	Units
Collector-Cutoff Current	$I_{CES}$	$V_{CE} = V_{CES}, V_{GE} = 0V$	-	-	1.0	mA
Gate Leakage Current	$I_{GES}$	$V_{GE} = V_{GES}, V_{CE} = 0V$	-	-	0.5	$\mu\text{A}$
Gate-Emitter Threshold Voltage	$V_{GE(th)}$	$I_C = 30\text{mA}, V_{CE} = 10V$	3.5	5.0	6.5	Volts
Collector-Emitter Saturation Voltage	$V_{CE(sat)}$	$I_C = 300A, V_{GE} = 15V$	-	2.7	3.5**	Volts
		$I_C = 300A, V_{GE} = 15V, T_j = 150^\circ\text{C}$	-	2.7	-	Volts
Total Gate Charge	$Q_G$	$V_{CC} = 300V, I_C = 300A, V_{GS} = 15V$	-	1500	-	nC
Diode Forward Voltage	$V_{FM}$	$I_E = 300A, V_{GS} = 0V$	-	-	2.5	Volts

\*\* Pulse width and repetition rate should be such that device junction temperature rise is negligible

### Dynamic Electrical Characteristics, $T_j = 25\text{ }^\circ\text{C}$ unless otherwise specified

Characteristics	Symbol	Test Conditions	Min.	Typ.	Max.	Units
Input Capacitance	$C_{ies}$		-	-	60	nF
Output Capacitance	$C_{oes}$	$V_{GE} = 0V, V_{CE} = 10V, f = 1\text{MHz}$	-	-	18	nF
Reverse Transfer Capacitance	$C_{res}$		-	-	12	nF
Resistive	Turn-on Delay Time	$V_{CC} = 300V, I_C = 300A,$ $V_{GE1} = V_{GE2} = 15V, R_G = 2.1\Omega$	-	-	400	ns
	Load					
Switch Times	Turn-off Delay Time	$V_{CC} = 300V, I_C = 300A,$ $V_{GE1} = V_{GE2} = 15V, R_G = 2.1\Omega$	-	-	800	ns
Diode Reverse Recovery Time	$t_{rr}$	$I_E = 300A, di_E/dt = -600A/\mu\text{s}$	-	-	200	ns
Diode Reverse Recovery Charge	$Q_{rr}$	$I_E = 300A, di_E/dt = -600A/\mu\text{s}$	-	4.0	-	$\mu\text{C}$

### Thermal and Mechanical Characteristics, $T_j = 25\text{ }^\circ\text{C}$ unless otherwise specified

Characteristics	Symbol	Test Conditions	Min.	Typ.	Max.	Units
Thermal Resistance, Junction to Case	$R_{th(j-c)}$	Per IGBT	-	-	0.11	$^\circ\text{C/W}$
Thermal Resistance, Junction to Case	$R_{th(j-c)}$	Per Free Wheel Diode	-	-	0.24	$^\circ\text{C/W}$
Contact Thermal Resistance	$R_{th(c-f)}$	Per Half Module	-	-	0.09	$^\circ\text{C/W}$

Powerex, Inc., 200 Hillis Street, Youngwood, Pennsylvania 15697-1800 (412) 925-7272  
 Powerex, Europe, S.A. 428 Avenue G. Durand, BP107, 72003 Le Mans, France (43) 41.14.14

**CM300DY-12E**  
**Dual IGBTMOD™ E-Series Module**  
 300 Amperes/600 Volts

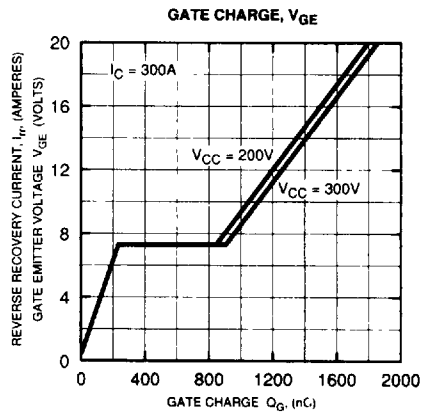
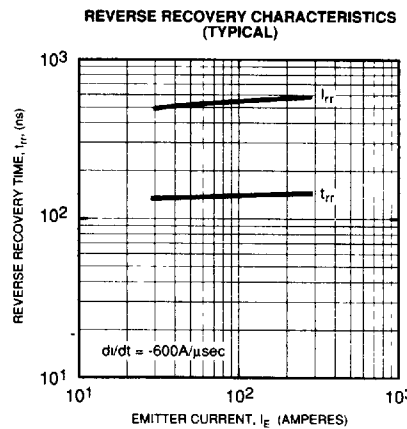
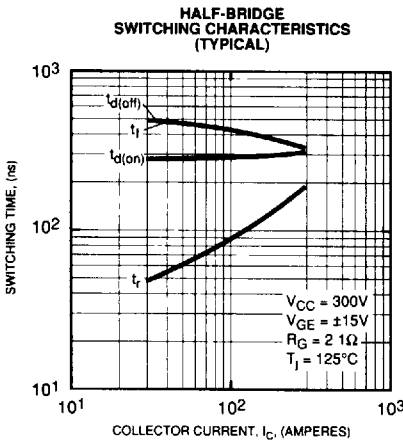
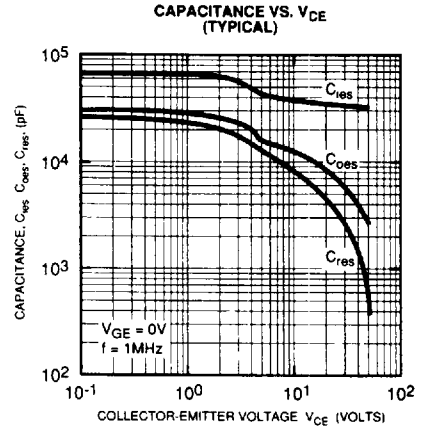
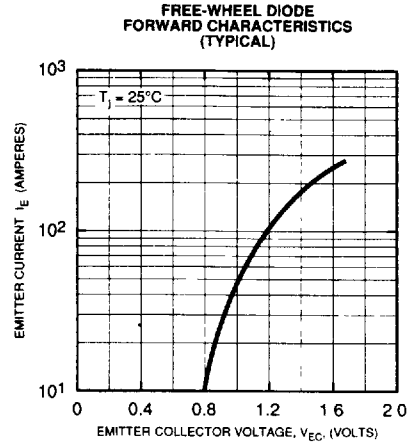
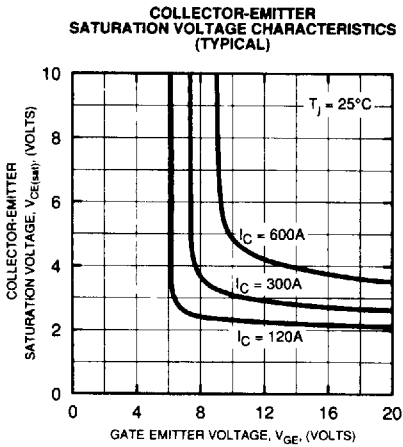
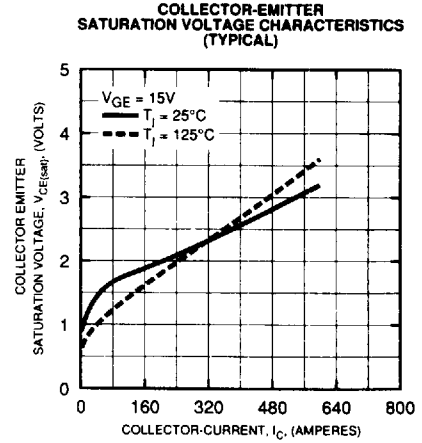
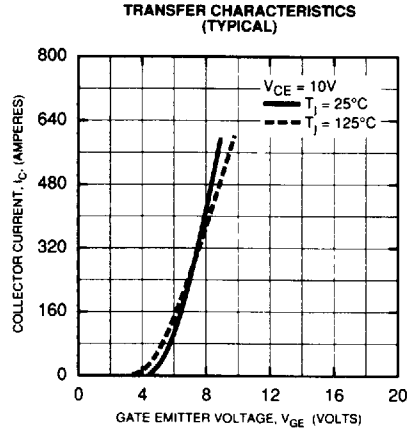
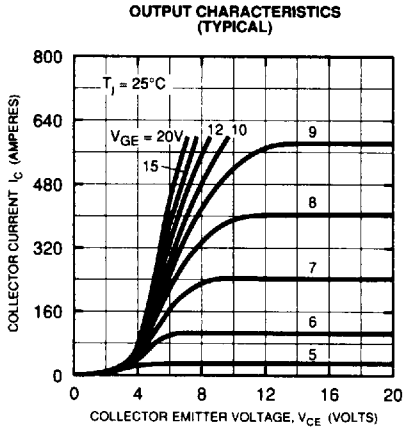

Powerex, Inc., 200 Hillis Street, Youngwood, Pennsylvania 15697-1800 (412) 925-7272  
 Powerex, Europe, S.A. 428 Avenue G. Durand, BP107, 72003 Le Mans, France (43) 41.14.14

**CM300DY-12E**  
**Dual IGBTMOD™ E-Series Module**  
 300 Amperes/600 Volts

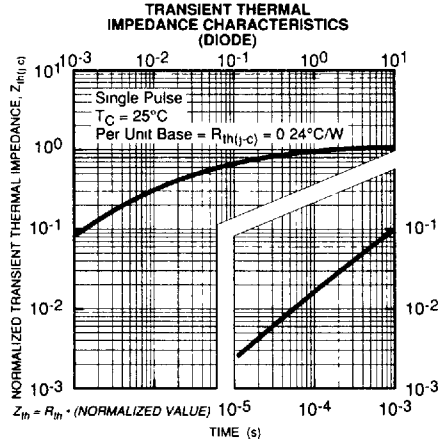
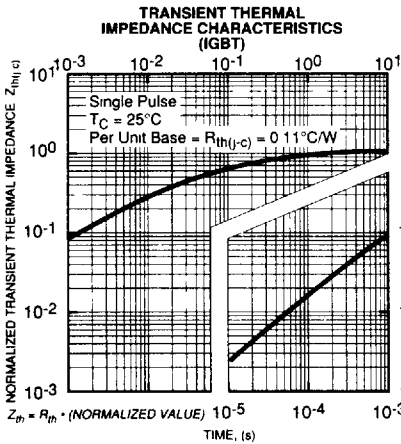

## SWITCHING TIME TEST CIRCUITS & WAVEFORMS

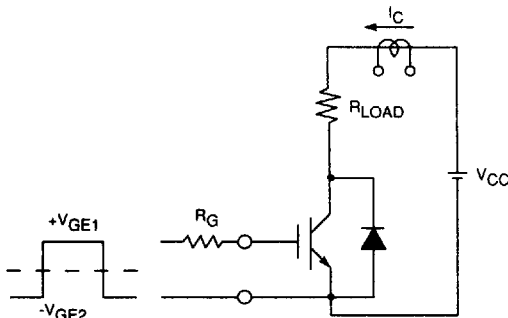

RESISTANCE LOAD SWITCHING TEST CIRCUIT

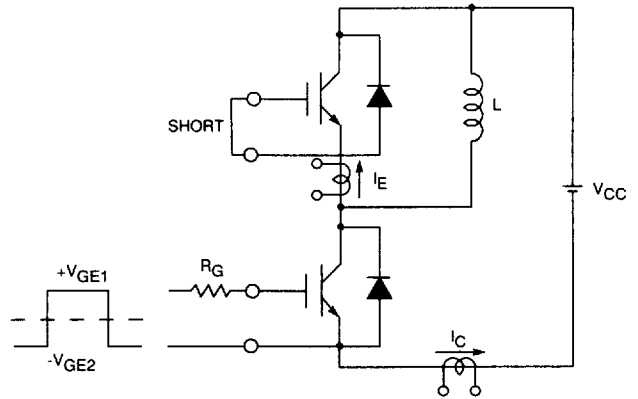

HALF-BRIDGE SWITCHING TEST CIRCUIT

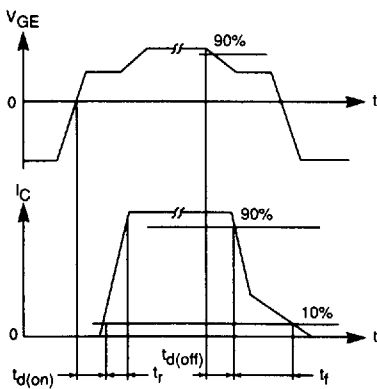

SWITCHING TIME TEST WAVEFORMS

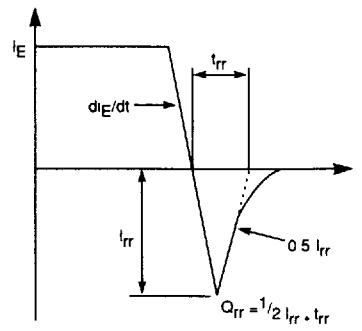

$t_{rr}, Q_{rr}$  WAVEFORMS