

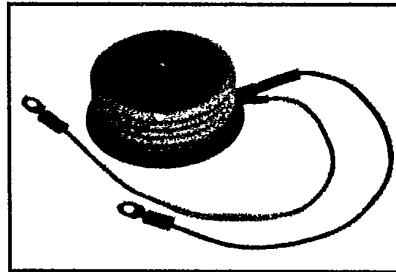

**C450**

Powerex, Inc. Hillis Street, Youngwood, Pennsylvania 15697 (412) 925-7272  
 Powerex Europe, S.A., 428 Ave. G. Durand, BP107, 72003 LeMans, France (43) 72.75.15

**Phase Control SCR**  
**1460-1640 Amperes Avg**  
**500-1400 Volts**

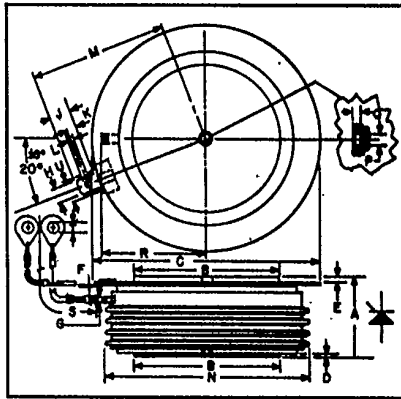

**C450**  
**Phase Control SCR**  
 1460-1640 Amperes/500-1400 Volts

**C450**  
**Outline Drawing**

Dimensions	Inches		Millimeters	
	Min.	Max.	Min.	Max.
A	1.020	1.065	25.90	27.05
B	1.845	1.855	46.86	47.12
C	—	2.940	—	74.68
D	.030	—	.76	—
E	.050	—	1.27	—
F	.017	.023	.43	.58
G	.057	.059	1.44	1.50
H	.186	.191	4.72	4.85
J	.245	.255	6.22	6.48
K	.115	.130	2.92	3.30
L	.064	.070	1.62	1.78
M	—	1.800	—	45.72
N	—	2.650	—	67.31
P	.135	.145	3.42	3.68
Q	.070	.100	1.77	2.54
R	—	1.355	—	34.42
S	12.219	12.343	310.36	313.51
T	.137	.153	3.47	3.89

**Description**

Powerex Silicon Controlled Rectifiers (SCR) are designed for phase control applications. These are all-diffused, Press-Pak (Pow-R-Disc) devices employing the field-proven amplifying (di/namic) gate.

**Features:**

- Low On-State Voltage
- High di/dt
- High dv/dt
- Hermetic Packaging
- Excellent Surge and I<sup>2</sup>t Ratings

**Applications:**

- Power Supplies
- Battery Chargers
- Motor Control
- Light Dimmers
- VAR Generators

**Ordering Information**

Example: Select the complete six or seven digit part number you desire from the table - i.e. C450P1 is a 1000 Volt, 1640 Ampere Phase Control SCR.

Type	Voltage		Current	
	V <sub>ORM</sub>	V <sub>RRM</sub>	I <sub>T</sub> (avg)	Code
C450	500	E	1460	2
	600	M		
	700	S	1640	1
	800	N		
	900	T		
	1000	P		
	1100	PA		
	1200	PB		
	1300	PC		
	1400	PD		



Powerex, Inc., Hillis Street, Youngwood, Pennsylvania 15697 (412) 925-7272

Powerex Europe, S.A., 428 Ave. G. Durand, BP107, 72003 LeMans, France (43) 72.75.15

### C450

Phase Control SCR

1460-1640 Amperes Avg/500-1400 Volts

### Absolute Maximum Ratings

	Symbol	C450-1	C450-2	Units
RMS On-State Current	$I_{T(RMS)}$	2575	2300	Amperes
Average On-State Current	$I_{T(av)}$	1640	1460	Amperes
Peak One-Cycle Surge (Non Repetitive) On-State Current (60Hz)	$I_{TSM}$	28500	25,000	Amperes
Peak One-Cycle Surge (Non-Repetitive) On-State Current (50Hz)	$I_{TSM}$	26,000	22,800	Amperes
Critical Rate-of-Rise of On-State Current (Non-Repetitive)	$di/dt$	800	800	Amperes/ $\mu$ s
Critical Rate-of-Rise of On-State Current (Repetitive)	$di/dt$	400	400	Amperes/ $\mu$ s
$I^2t$ (for Fusing), One Cycle at 60Hz	$I^2t$	$3.4 \times 10^6$	$2.6 \times 10^6$	A <sup>2</sup> sec
Peak Gate Power Dissipation	$P_{GM}$	200	200	Watts
Average Gate Power Dissipation	$P_{G(av)}$	5	5	Watts
Storage Temperature	$T_{STG}$	-40 to 150	-40 to 150	°C
Operating Temperature	$T_J$	-40 to 125	-40 to 125	°C
Mounting Force <sup>Ⓞ</sup>		5500 to 6000	5500 to 6000	lb.
Mounting Force <sup>Ⓞ</sup>		24.5 to 26.7	24.5 to 26.7	kN

### Electrical and Thermal Characteristics

Characteristics	Symbol	Test Conditions	C450-1	C450-2	Units
<b>Current—Conducting State Maximums</b>					
Peak On-State Voltage	$V_{TM}$	$I_{TM} = 3000A$ Peak, $T_J = 25^\circ C$	1.4	1.65	Volts
C450					
<b>Voltage—Blocking State Maximums</b>					
Forward Leakage, Peak	$I_{DRM}$	$T_J = 125^\circ C, V = V_{DRM}$	45		mA
Reverse Leakage, Peak	$I_{RRM}$	$T_J = 125^\circ C, V = V_{RRM}$	45		mA
<b>Switching</b>					
Typical Turn-Off Time	$t_q$	$T_J = 125^\circ C, I_T = 2000A, \text{Pulse Width} = 1000 \mu\text{sec}; V_R = 50V; dv/dt = 200V/\mu\text{sec}; \text{Linear to } V_{DRM}; di_R/dt = 25A/\mu\text{sec}; VG = 0, R_L = 100\Omega$	150		$\mu\text{sec}$
Typical Delay Time	$t_d$	$T_J = 25^\circ C; I_T = 50A; \text{Gate supply } 20V; R_L = 20\Omega; 0.1 \mu\text{sec Rise Time}$		.7	$\mu\text{sec}$
Min. Critical $dv/dt$ exponential to $V_{DRM}$	$dv/dt$	$T_J = 125^\circ C$	400		V/ $\mu\text{sec}$
<b>Thermal</b>					
Maximum Thermal Resistance, <sup>Ⓞ</sup> double sided cooling Junction to Case	$R_{\theta JC}$			.025	°C/Watt
Case to Sink, Lubricated	$R_{\theta CS}$			.0075	°C/Watt
<b>Gate—Maximum Parameters</b>					
Gate Current to Trigger	$I_{GT}$	$T_J = 25^\circ C, V_D = 20V, R_L = 3 \Omega$	200		mA
Gate Voltage to Trigger	$V_{GT}$	$T_J = -40^\circ \text{ to } 125^\circ C, V_D = 20V, R_L = 3 \Omega$	5		Volts
Non-Triggerring Gate Voltage	$V_{GDM}$	$T_J = 125^\circ C, V_D = \text{rated } V_{DRM}, R_L = 1000 \Omega$	.15		Volts
Peak Forward Gate Current	$I_{GTM}$		10		Amperes
Peak Reverse Gate Voltage	$V_{GRM}$		5		Volts

<sup>Ⓞ</sup> Consult recommended mounting procedures.



Powerex, Inc., Hillis Street, Youngwood, Pennsylvania 15697 (412) 925-7272  
 Powerex Europe, S.A., 428 Ave. G. Durand, BP107, 72003 LeMans, France (43) 72.75.15

**C450**  
 Phase Control SCR  
 1460-1640 Amperes Avg/500-1400 Volts

MAXIMUM ON-STATE CHARACTERISTICS

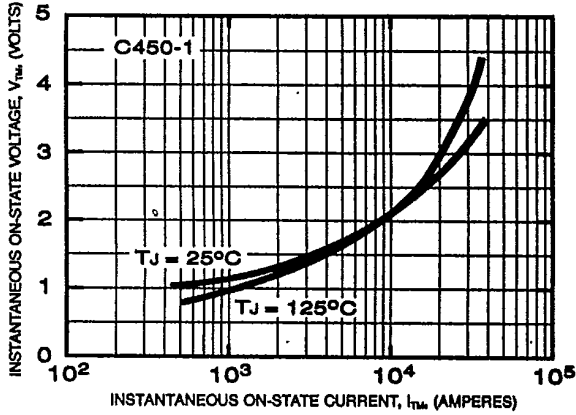

TRANSIENT THERMAL IMPEDANCE CHARACTERISTICS (JUNCTION TO CASE)

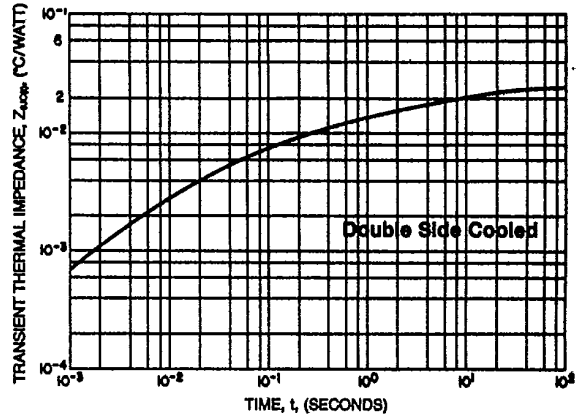

MAXIMUM ALLOWABLE CASE TEMPERATURE (SINUSOIDAL WAVEFORM)

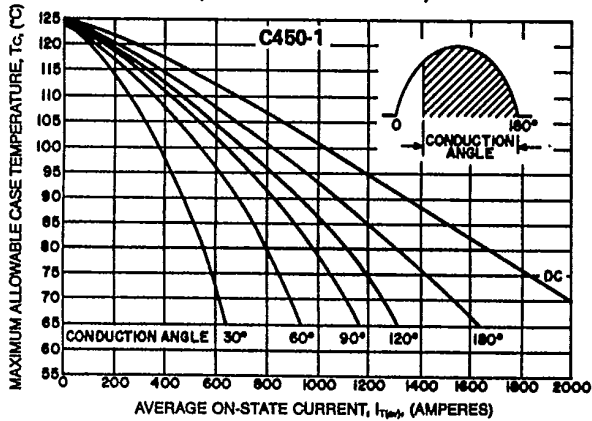

MAXIMUM ON-STATE POWER DISSIPATION (SINUSOIDAL WAVEFORM)

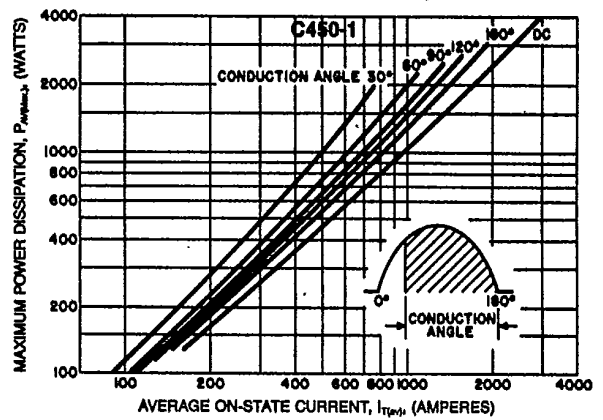

MAXIMUM ALLOWABLE CASE TEMPERATURE (RECTANGULAR WAVEFORM)

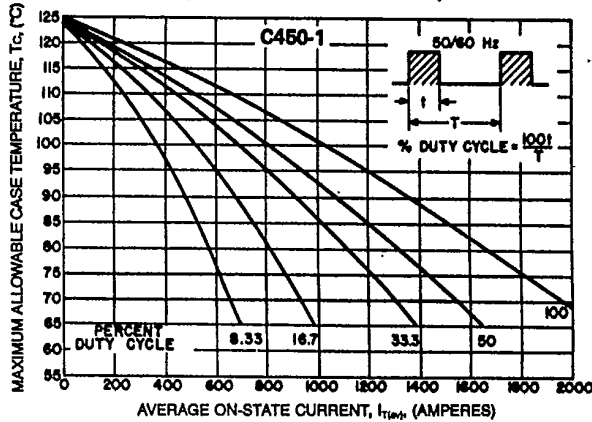

MAXIMUM ON-STATE POWER DISSIPATION (RECTANGULAR WAVEFORM)

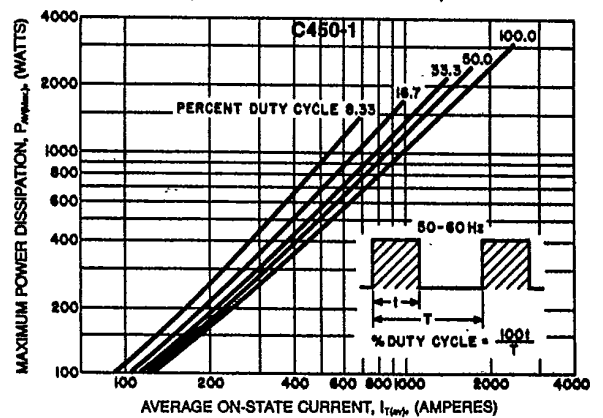



Powerex, Inc., Hillis Street, Youngwood, Pennsylvania 15697 (412) 925-7272  
 Powerex Europe, S.A., 428 Ave. G. Durand, BP107, 72003 LeMans, France (43) 72.75.15

**C450**  
 Phase Control SCR  
 1460-1640 Amperes Avg/500-1400 Volts

MAXIMUM ON-STATE CHARACTERISTICS

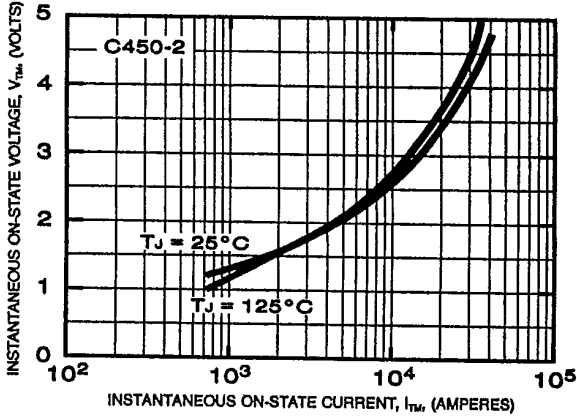

SUB-CYCLE SURGE AND  $I^2t$  RATINGS (RATED LOAD CONDITIONS)

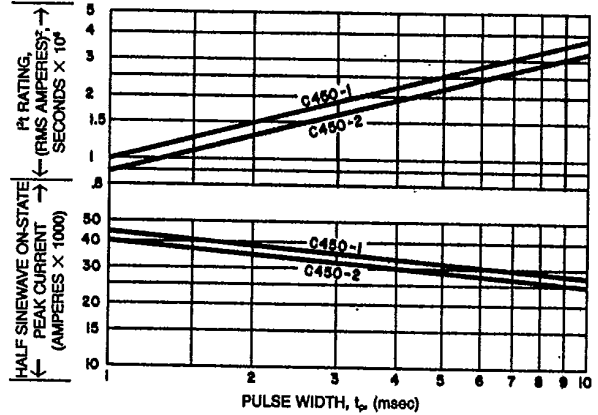

MAXIMUM ALLOWABLE CASE TEMPERATURE (SINUSOIDAL WAVEFORM)

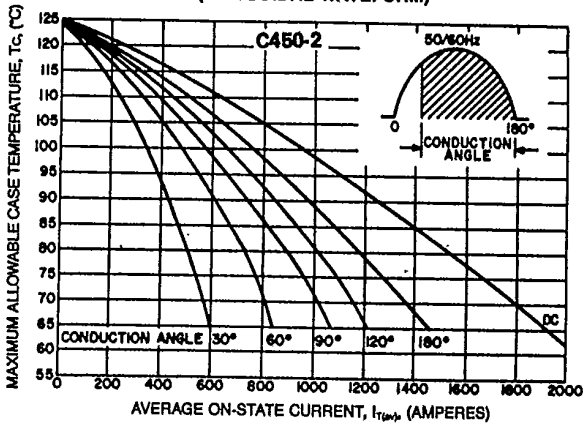

MAXIMUM ON-STATE POWER DISSIPATION (SINUSOIDAL WAVEFORM)

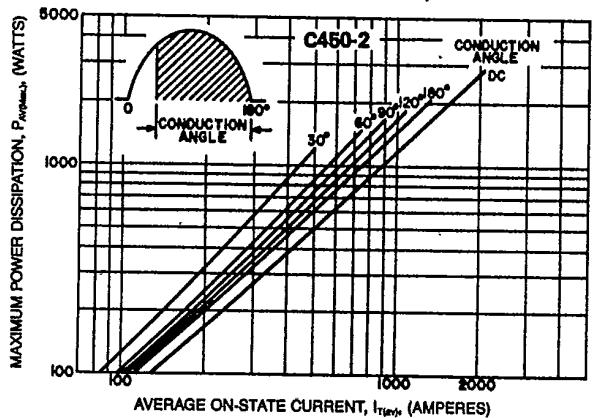

MAXIMUM ALLOWABLE CASE TEMPERATURE (RECTANGULAR WAVEFORM)

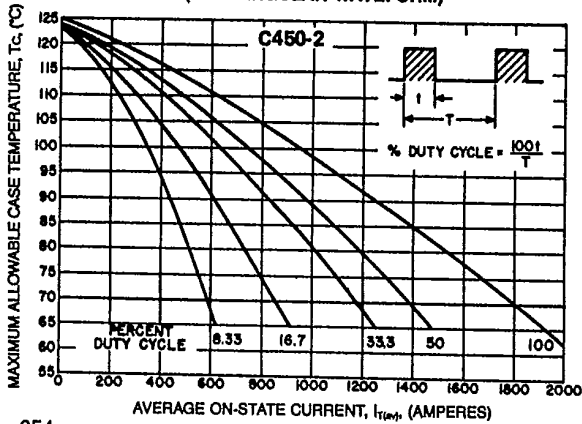

MAXIMUM ON-STATE POWER DISSIPATION (RECTANGULAR WAVEFORM)

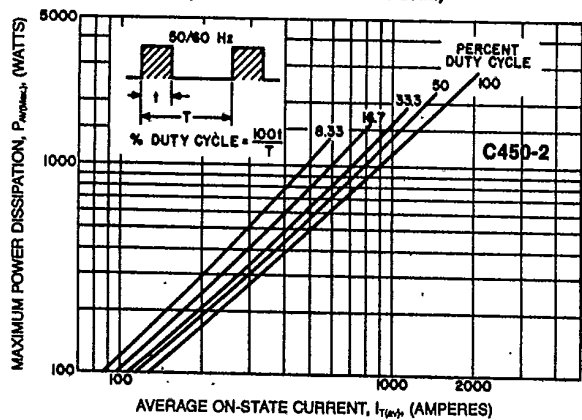



Powerex, Inc., Hillis Street, Youngwood, Pennsylvania 15697 (412) 925-7272  
 Powerex Europe, S.A., 428 Ave. G. Durand, BP107, 72003 LeMans, France (43) 72.75.15

**C450**  
 Phase Control SCR  
 1460-1640 Amperes Avg/500-1400 Volts

TYPICAL RECOVERED CHARGE

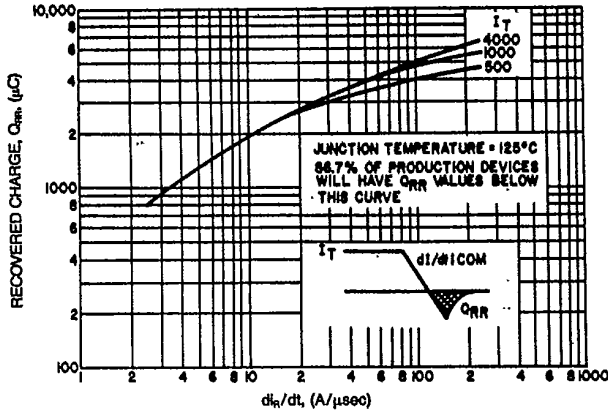

$I_{T(av)}$  vs.  $T_A$  (VARIOUS HEAT EXCHANGERS)

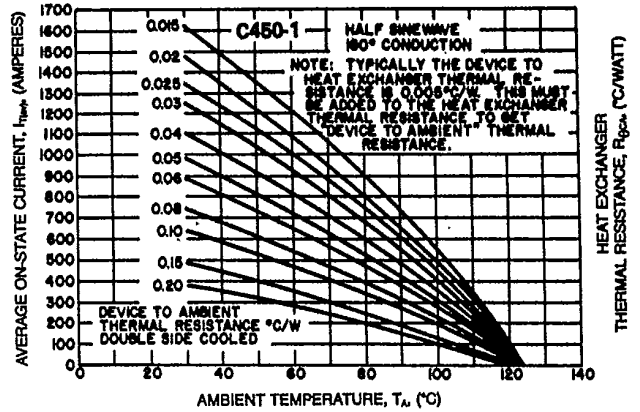

$I_{T(av)}$  vs.  $T_A$  (VARIOUS HEAT EXCHANGERS)

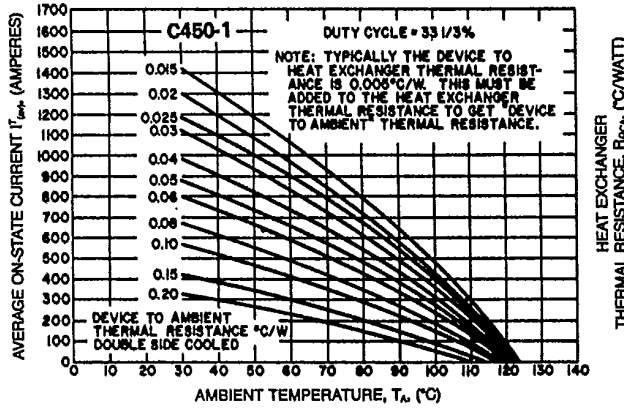

$I_{T(av)}$  vs.  $T_A$  (VARIOUS HEAT EXCHANGERS)

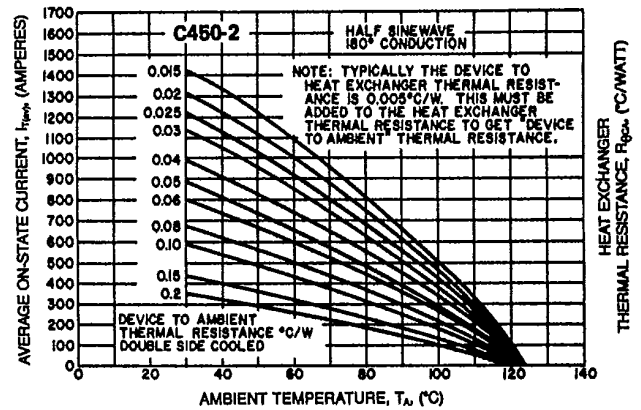

$I_{T(av)}$  vs.  $T_A$  (VARIOUS HEAT EXCHANGERS)

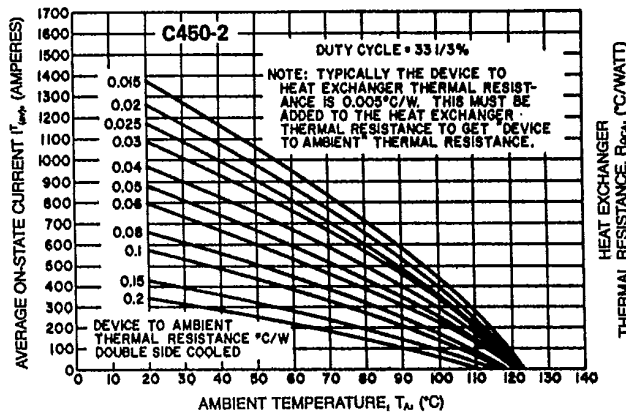

SURGE SUPPRESSION RATING

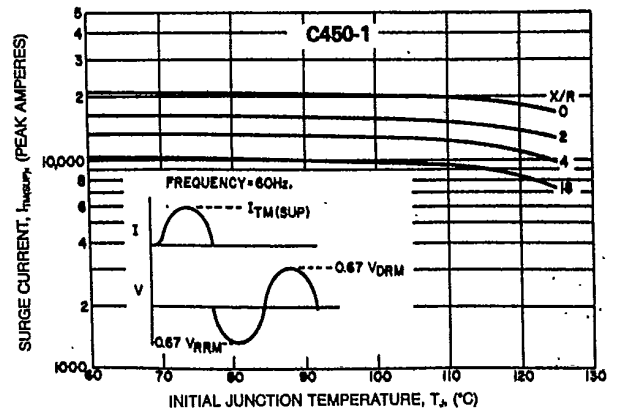



Powerex, Inc., Hillis Street, Youngwood, Pennsylvania 15697 (412) 925-7272

Powerex Europe, S.A., 428 Ave. G. Durand, BP107, 72003 LeMans, France (43) 72.75.15

C450

Phase Control SCR

1460-1840 Amperes Avg/500-1400 Volts

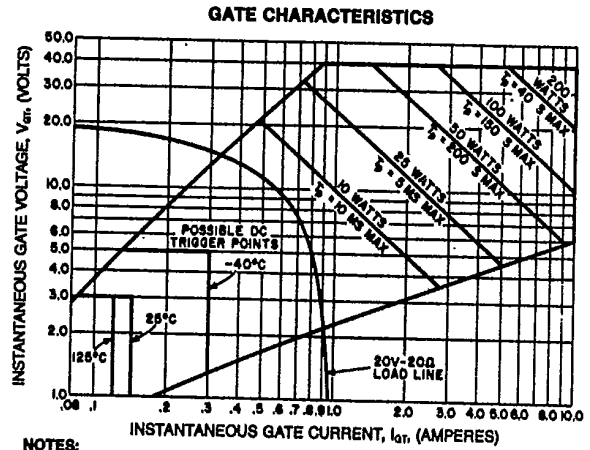
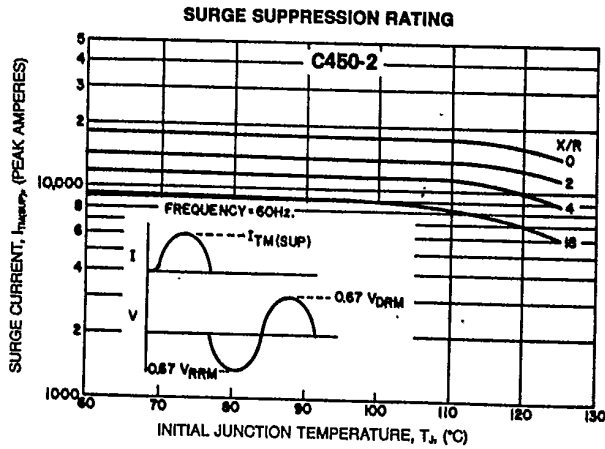

**NOTES:**

1. Maximum allowable average gate dissipation = 5 watts.
2. The locus of possible DC trigger points lies outside the boundaries shown at various case temperatures.
3.  $T_p$  = rectangular gate current pulse width (6 $\mu$ s min. duration, 1.0 $\mu$ s max. rise time).
4. Maximum long-term, repetitive anode  $di/dt$  = 400 Amps/ $\mu$ s with 20V - 20 $\Omega$  gate source.