

# DATA SHEET

## **BLF175** HF/VHF power MOS transistor

Product specification

September 1992

# HF/VHF power MOS transistor

# BLF175

## FEATURES

- High power gain
- Low intermodulation distortion
- Easy power control
- Good thermal stability
- Withstands full load mismatch
- Gold metallization ensures excellent reliability.

## DESCRIPTION

Silicon N-channel enhancement mode vertical D-MOS transistor designed for large signal amplifier applications in the HF/VHF frequency range.

The transistor has a 4-lead, SOT123 flange envelope, with a ceramic cap. All leads are isolated from the flange.

A marking code, showing gate-source voltage ( $V_{GS}$ ) information is provided for matched pair applications. Refer to the 'General' section for further information.

## PIN CONFIGURATION

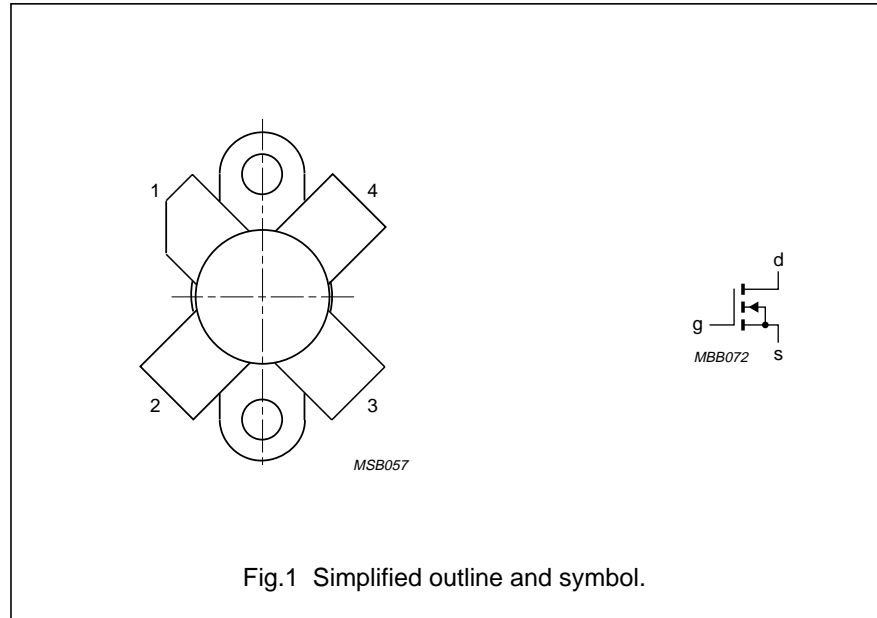

Fig.1 Simplified outline and symbol.

## CAUTION

The device is supplied in an antistatic package. The gate-source input must be protected against static charge during transport and handling.

## WARNING

**Product and environmental safety - toxic materials**

This product contains beryllium oxide. The product is entirely safe provided that the BeO disc is not damaged. All persons who handle, use or dispose of this product should be aware of its nature and of the necessary safety precautions. After use, dispose of as chemical or special waste according to the regulations applying at the location of the user. It must never be thrown out with the general or domestic waste.

## PINNING - SOT123

PIN	DESCRIPTION
1	drain
2	source
3	gate
4	source

## QUICK REFERENCE DATA

RF performance at  $T_h = 25\text{ }^\circ\text{C}$  in a common source test circuit.

MODE OF OPERATION	f (MHz)	$V_{DS}$ (V)	$I_{DQ}$ (mA)	$P_L$ (W)	$G_p$ (dB)	$\eta_D$ (%)	$d_3$ (dB)
class-A	28	50	800	8 (PEP)	> 24	–	< –40
class-AB	28	50	150	30 (PEP)	typ. 24	typ. 40 (note 1)	typ. –35
CW, class-B	108	50	30	30	typ. 20	typ. 65	–

## Note

1. 2-tone efficiency.

# HF/VHF power MOS transistor

BLF175

## LIMITING VALUES

In accordance with the Absolute Maximum System (IEC 134).

SYMBOL	PARAMETER	CONDITIONS	MIN.	MAX.	UNIT
$V_{DS}$	drain-source voltage		–	110	V
$\pm V_{GS}$	gate-source voltage		–	20	V
$I_D$	DC drain current		–	4	A
$P_{tot}$	total power dissipation	up to $T_{mb} = 25\text{ }^\circ\text{C}$	–	68	W
$T_{stg}$	storage temperature		–65	150	$^\circ\text{C}$
$T_j$	junction temperature		–	200	$^\circ\text{C}$

## THERMAL RESISTANCE

SYMBOL	PARAMETER	CONDITIONS	THERMAL RESISTANCE
$R_{th\ j-mb}$	thermal resistance from junction to mounting base	$T_{mb} = 25\text{ }^\circ\text{C}; P_{tot} = 68\text{ W}$	2.6 K/W
$R_{th\ mb-h}$	thermal resistance from mounting base to heatsink	$T_{mb} = 25\text{ }^\circ\text{C}; P_{tot} = 68\text{ W}$	0.3 K/W

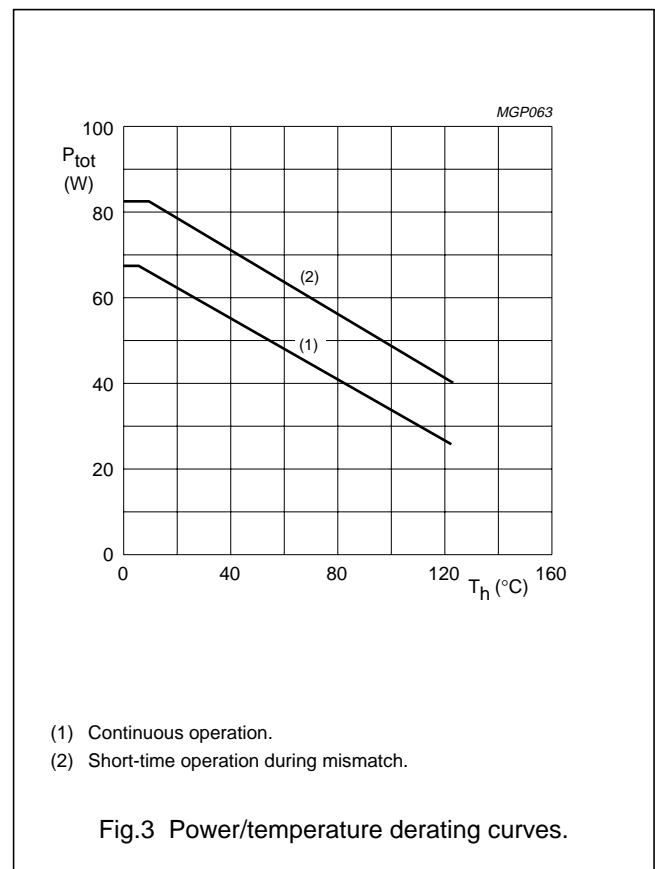
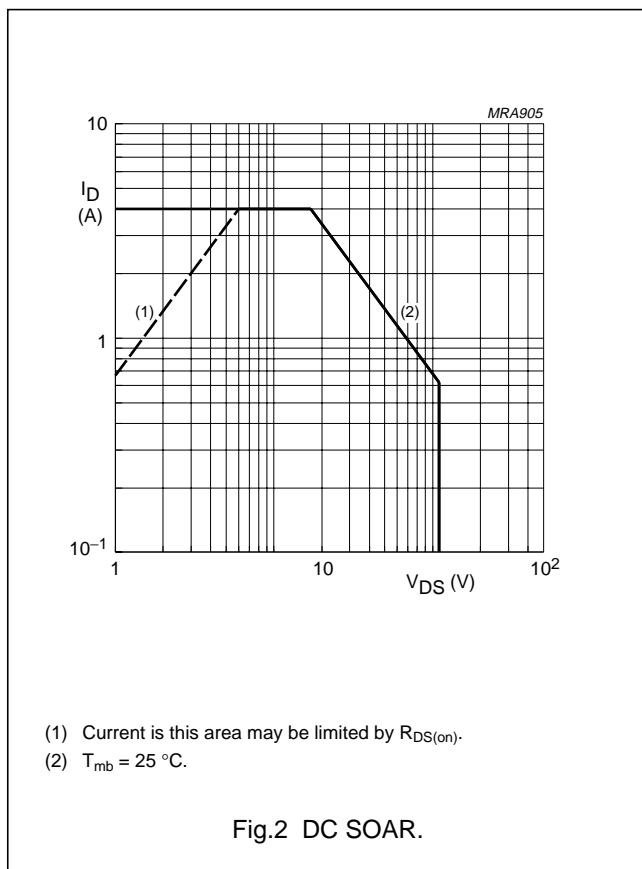

HF/VHF power MOS transistor

BLF175

**CHARACTERISTICS**

$T_j = 25\text{ }^\circ\text{C}$  unless otherwise specified.

SYMBOL	PARAMETER	CONDITIONS	MIN.	TYP.	MAX.	UNIT
$V_{(BR)DSS}$	drain-source breakdown voltage	$I_D = 10\text{ mA}; V_{GS} = 0$	110	–	–	V
$I_{DSS}$	drain-source leakage current	$V_{GS} = 0; V_{DS} = 50\text{ V}$	–	–	100	$\mu\text{A}$
$I_{GSS}$	gate-source leakage current	$\pm V_{GS} = 20\text{ V}; V_{DS} = 0$	–	–	1	$\mu\text{A}$
$V_{GS(th)}$	gate-source threshold voltage	$I_D = 10\text{ mA}; V_{DS} = 10\text{ V}$	2	–	4.5	V
$\Delta V_{GS}$	gate-source voltage difference of matched pairs	$I_D = 10\text{ mA}; V_{DS} = 10\text{ V}$	–	–	100	mV
$g_{fs}$	forward transconductance	$I_D = 1\text{ A}; V_{DS} = 10\text{ V}$	1.1	1.6	–	S
$R_{DS(on)}$	drain-source on-state resistance	$I_D = 1\text{ A}; V_{GS} = 10\text{ V}$	–	0.75	1.5	$\Omega$
$I_{DSX}$	on-state drain current	$V_{GS} = 10\text{ V}; V_{DS} = 10\text{ V}$	–	5.5	–	A
$C_{is}$	input capacitance	$V_{GS} = 0; V_{DS} = 50\text{ V}; f = 1\text{ MHz}$	–	130	–	pF
$C_{os}$	output capacitance	$V_{GS} = 0; V_{DS} = 50\text{ V}; f = 1\text{ MHz}$	–	36	–	pF
$C_{rs}$	feedback capacitance	$V_{GS} = 0; V_{DS} = 50\text{ V}; f = 1\text{ MHz}$	–	3.7	–	pF

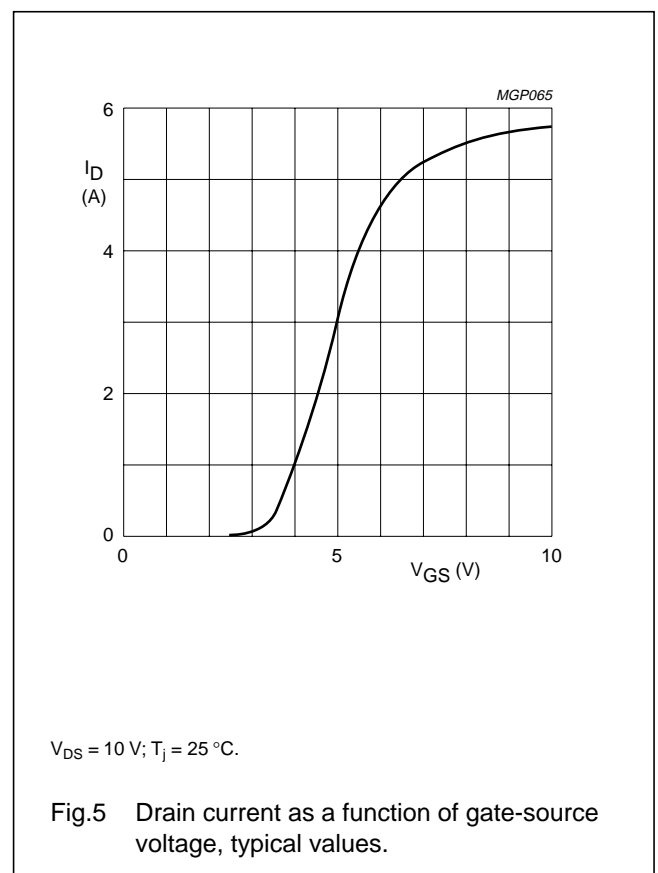
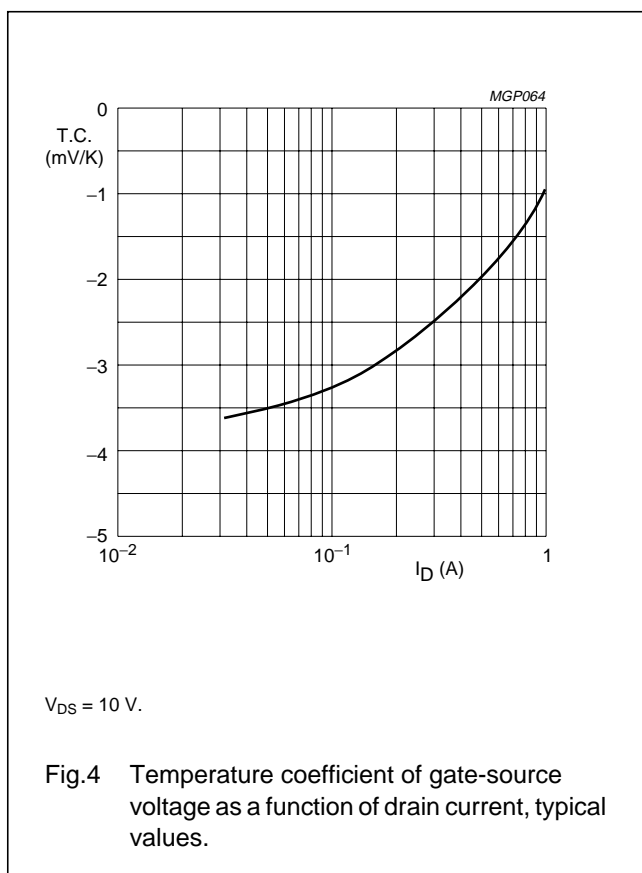

HF/VHF power MOS transistor

BLF175

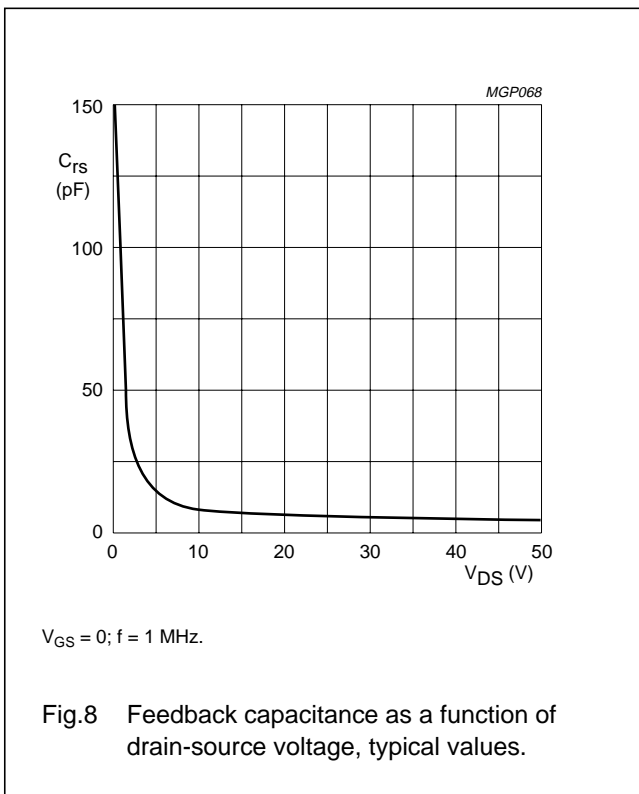
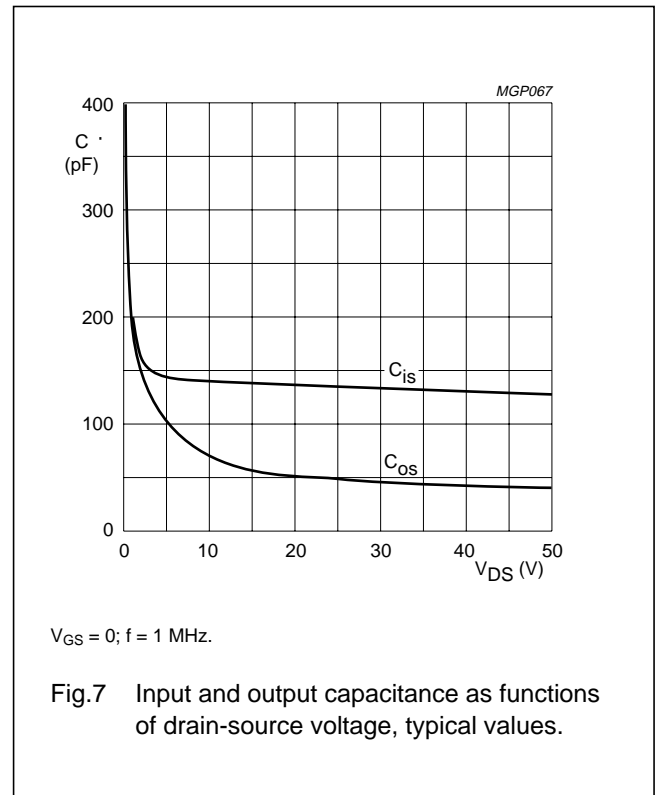
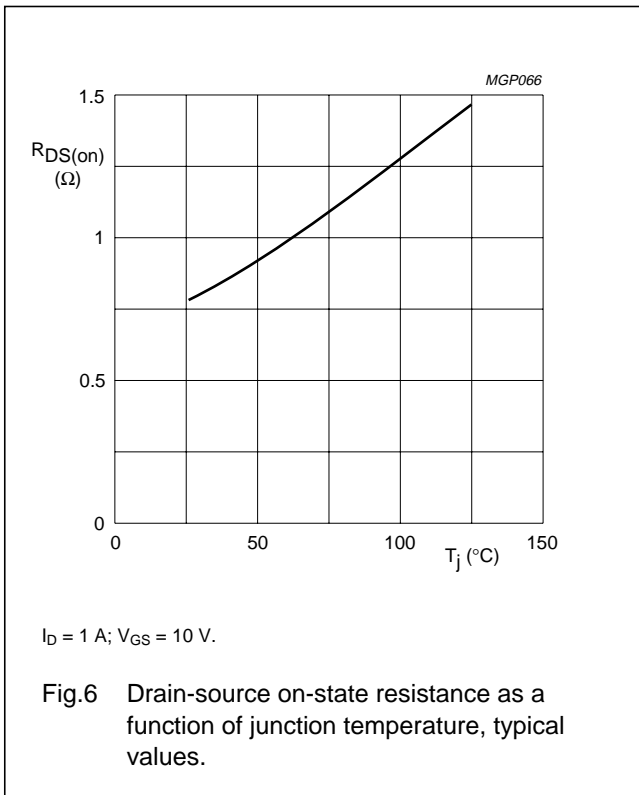

HF/VHF power MOS transistor

BLF175

APPLICATION INFORMATION FOR CLASS-A OPERATION

$T_h = 25\text{ }^\circ\text{C}$ ;  $R_{th\text{ mb-h}} = 0.3\text{ K/W}$ ; unless otherwise specified.

RF performance in SSB operation in a common source circuit.

$f_1 = 28.000\text{ MHz}$ ;  $f_2 = 28.001\text{ MHz}$ .

$P_L$ (W)	f (MHz)	$V_{DS}$ (V)	$I_{DQ}$ (mA)	$G_P$ (dB)	$d_3$ (dB) (note 1)	$d_5$ (dB) (note 1)	$R_{GS}$ ( $\Omega$ )
0 to 8 (PEP)	28	50	800	> 24 typ. 28	> -40 typ. -44	< -40 typ. -64	24 24

Note

1. Stated figures are maximum values encountered at any driving level between the specified value of PEP and are referred to the according level of either the equal amplified tones. Related to the according peak envelope power these figures should be decreased by 6 dB.

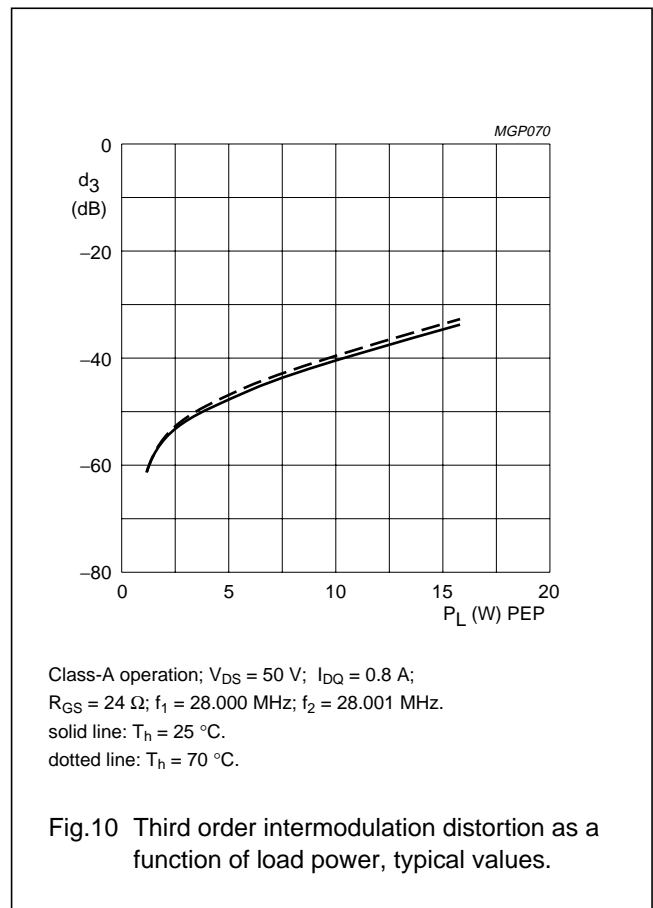
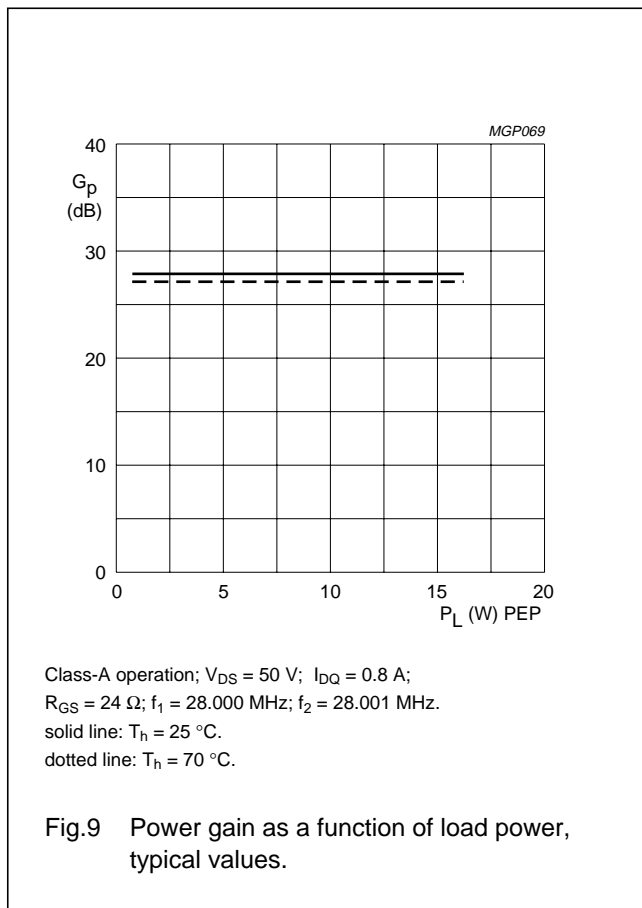

HF/VHF power MOS transistor

BLF175

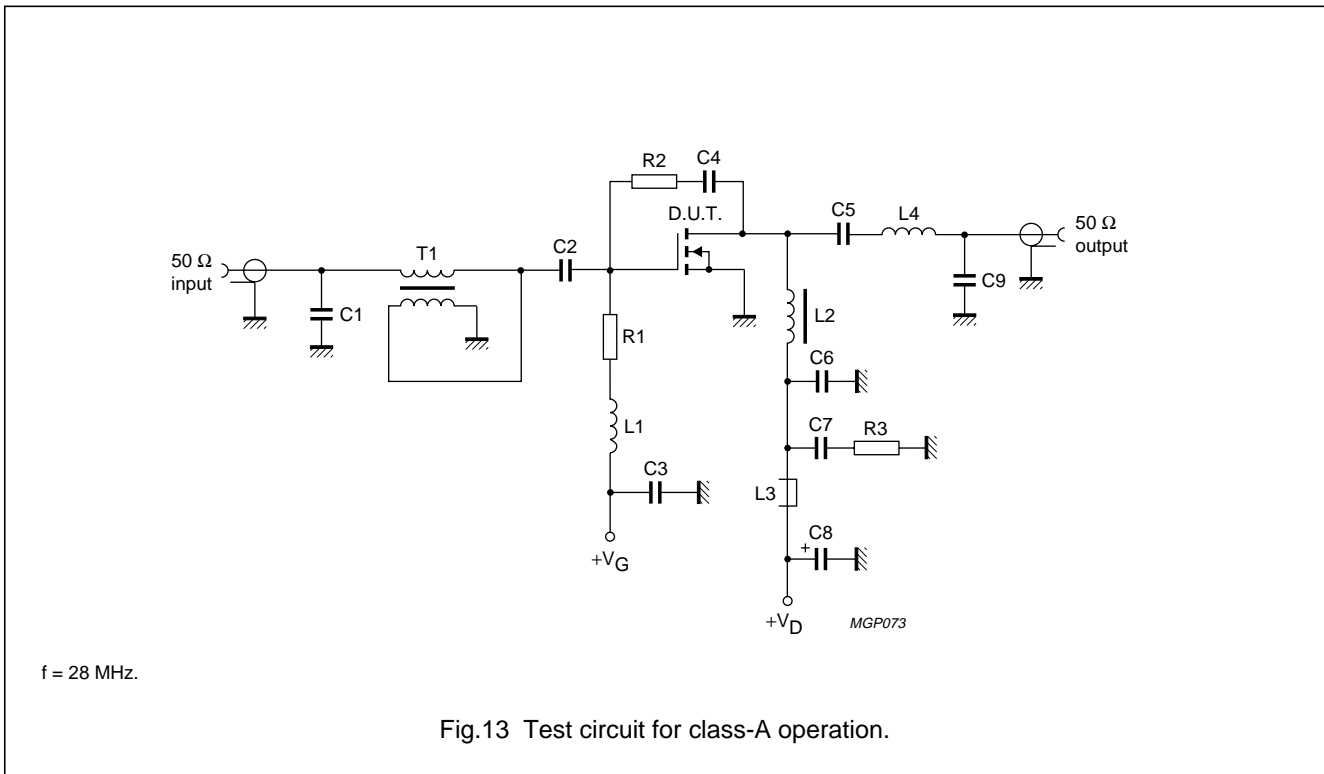
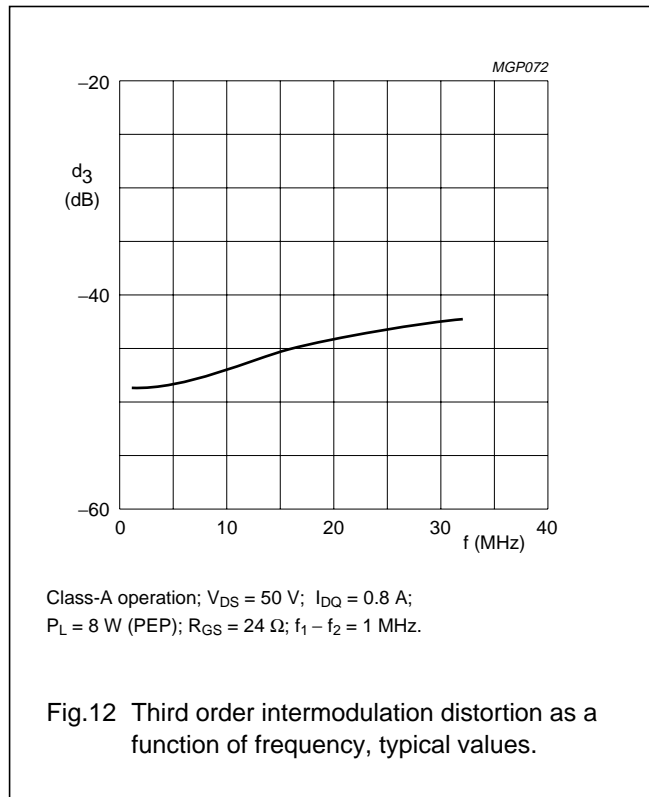
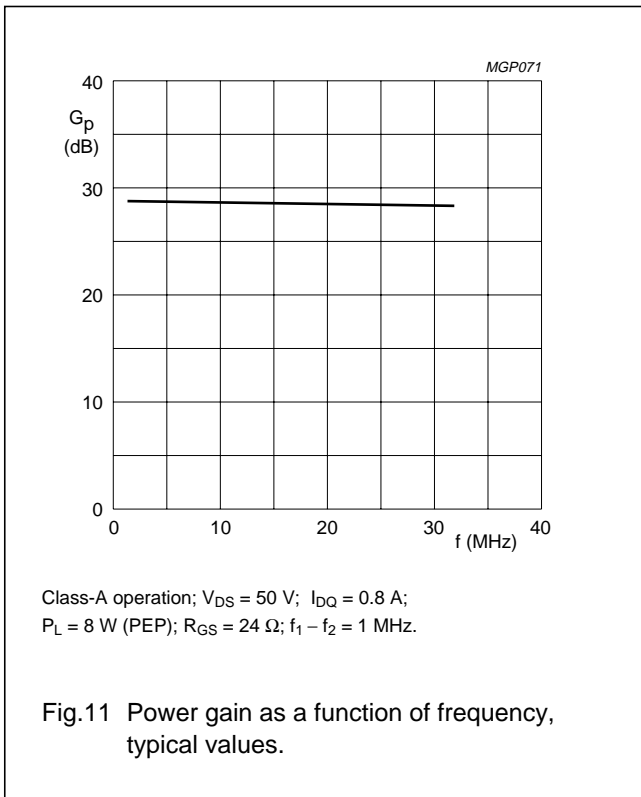

## HF/VHF power MOS transistor

BLF175

## List of components (class-A test circuit)

COMPONENT	DESCRIPTION	VALUE	DIMENSIONS	CATALOGUE NO.
C1	multilayer ceramic chip capacitor (note 1)	39 pF		
C2	multilayer ceramic chip capacitor	$3 \times 10$ nF		2222 852 47103
C3, C4, C6	multilayer ceramic chip capacitor	100 nF		2222 852 47104
C5	multilayer ceramic chip capacitor	10 nF		2222 852 47103
C7	multilayer ceramic chip capacitor	$3 \times 100$ nF		2222 852 47104
C8	aluminium electrolytic capacitor	10 $\mu$ F, 63 V		2222 030 28109
C9	multilayer ceramic chip capacitor (note 1)	24 pF		
L1	4 turns enamelled 0.6 mm copper wire	86 nH	length 3.3 mm; int. dia. 5 mm; leads 2 x 2 mm	
L2	36 turns enamelled 0.7 mm copper wire wound on a rod grade 4B1 Ferroxcube drain choke	20 $\mu$ H	length 30 mm; int. dia. 5 mm	4330 030 30031
L3	grade 3B Ferroxcube wideband RF choke			4312 020 36640
L4	8 turns enamelled 1 mm copper wire	189 nH	length 9.5 mm; int. dia. 5 mm; leads 2 x 3 mm	
R1	0.4 W metal film resistor	24 $\Omega$		
R2	0.4 W metal film resistor	1500 $\Omega$		
R3	0.4 W metal film resistor	10 $\Omega$		
T1	4 : 1 transformer; 18 turns twisted pair of 0.25 mm copper wire with 10 twists per cm, wound on a grade 4C6 toroidal core		dimensions 9 x 6 x 3 mm	4322 020 97171

## Note

1. American Technical Ceramics (ATC) capacitor, type 100B or other capacitor of the same quality.



HF/VHF power MOS transistor

BLF175

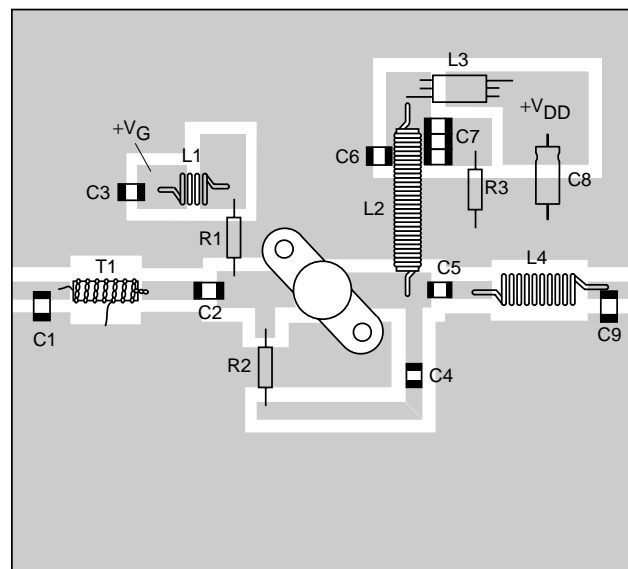
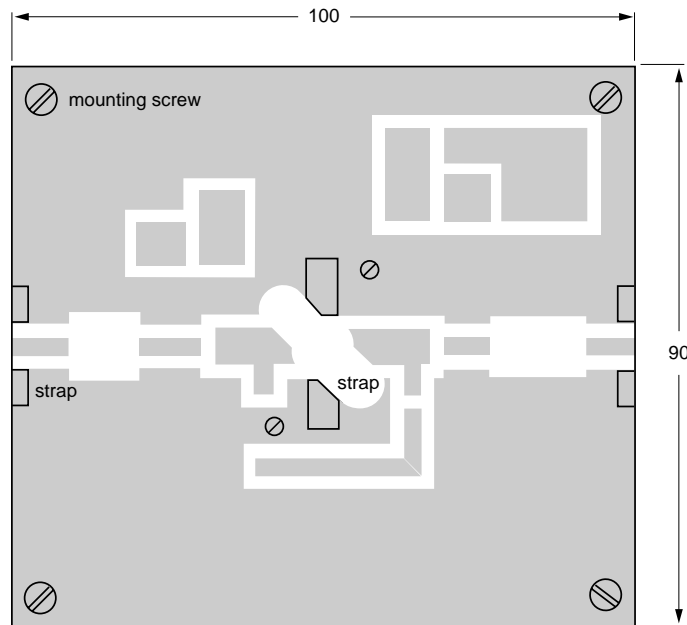

MGP074

Note: The circuit and components are situated on one side of the epoxy fibre-glass board, the other side being fully metallized to serve as earth. Earth connections are made by means of hollow rivets and straps at the two edges and under the source contacts.

Fig.14 Component layout for 28 MHz class-A test circuit.

HF/VHF power MOS transistor

BLF175

**APPLICATION INFORMATION FOR CLASS-AB OPERATION**

$T_h = 25\text{ }^\circ\text{C}$ ;  $R_{th\text{ mb-h}} = 0.3\text{ K/W}$ ; unless otherwise specified.

RF performance in SSB operation in a common source circuit.

$f_1 = 28.000\text{ MHz}$ ;  $f_2 = 28.001\text{ MHz}$ .

$P_L$ (W)	f (MHz)	$V_{DS}$ (V)	$I_{DQ}$ (mA)	$G_P$ (dB)	$\eta_D$ (%)	$d_3$ (dB) (note 1)	$d_5$ (dB) (note 1)	$R_{GS}$ ( $\Omega$ )
30 (PEP)	28	50	150	typ. 24	typ. 40 (note 2)	typ. -35	typ. -40	22

**Notes**

1. Stated figures are maximum values encountered at any driving level between the specified value of PEP and are referred to the according level of either the equal amplified tones. Related to the according peak envelope power these figures should be decreased by 6 dB.
2. 2-tone efficiency.

**Ruggedness in class-AB operation**

The BLF175 is capable of withstanding a load mismatch corresponding to  $V_{SWR} = 50$  through all phases at  $P_L = 30\text{ W}$  single tone under the following conditions:

$V_{DS} = 50\text{ V}$ ;  $f = 28\text{ MHz}$ .

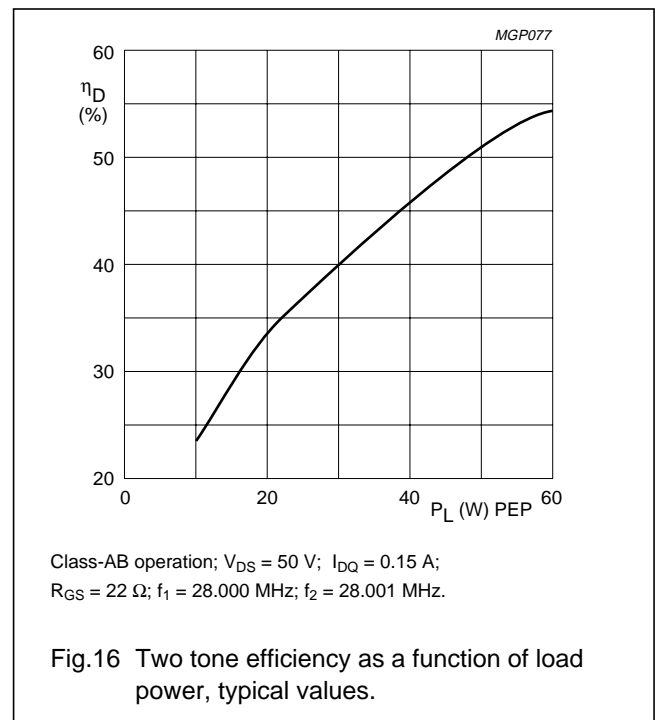
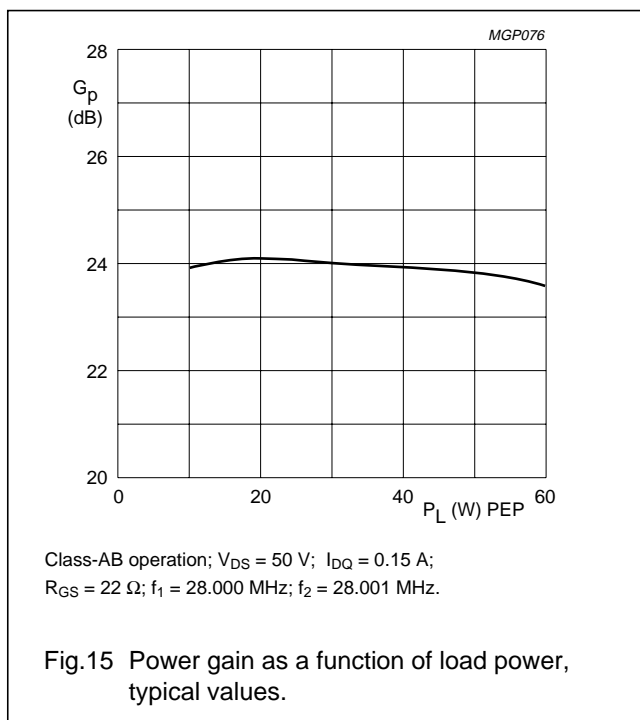

HF/VHF power MOS transistor

BLF175

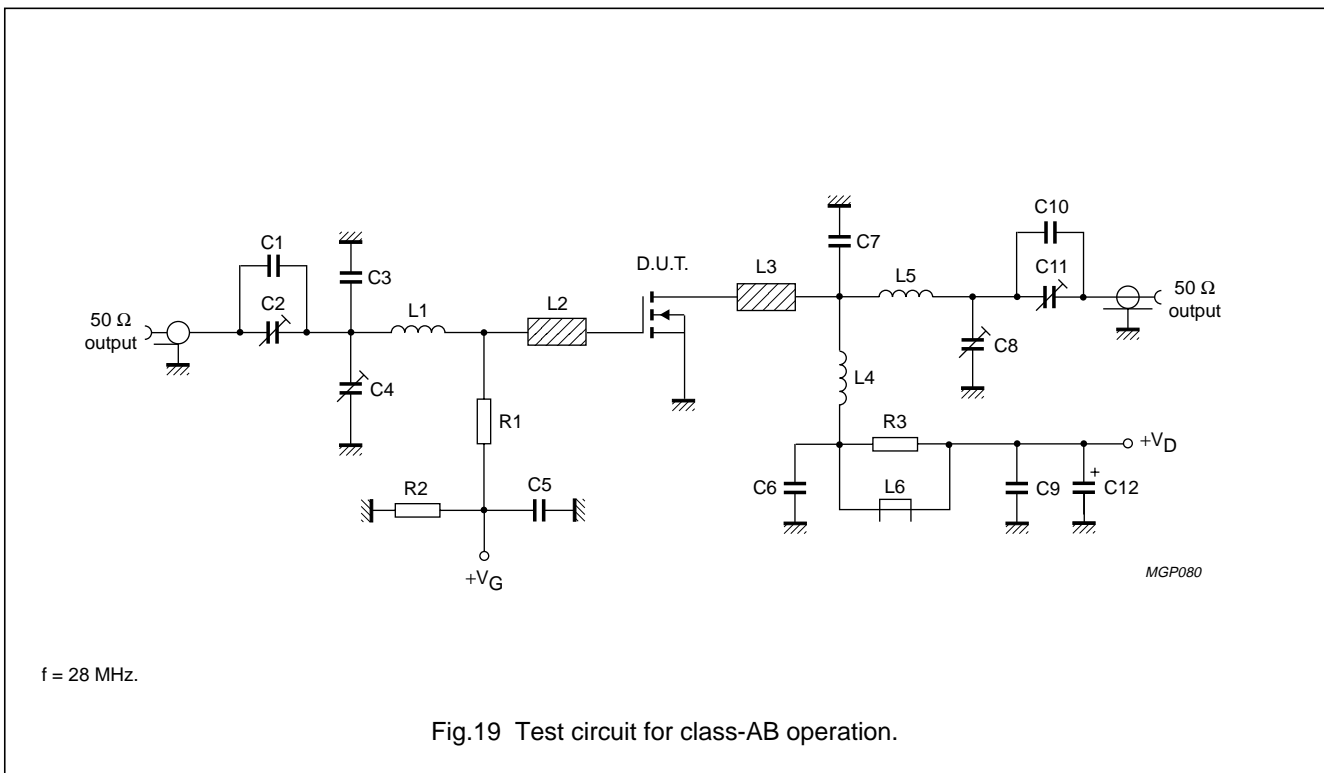
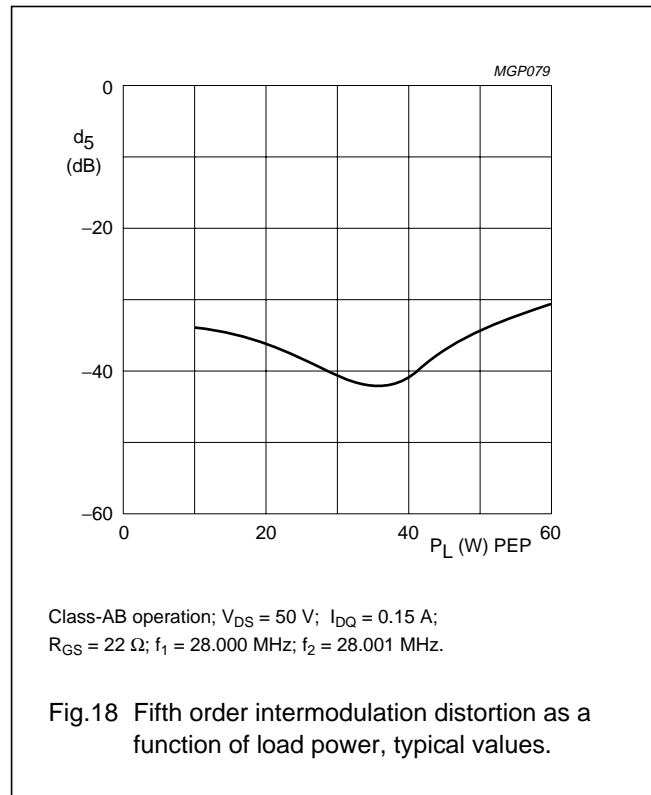
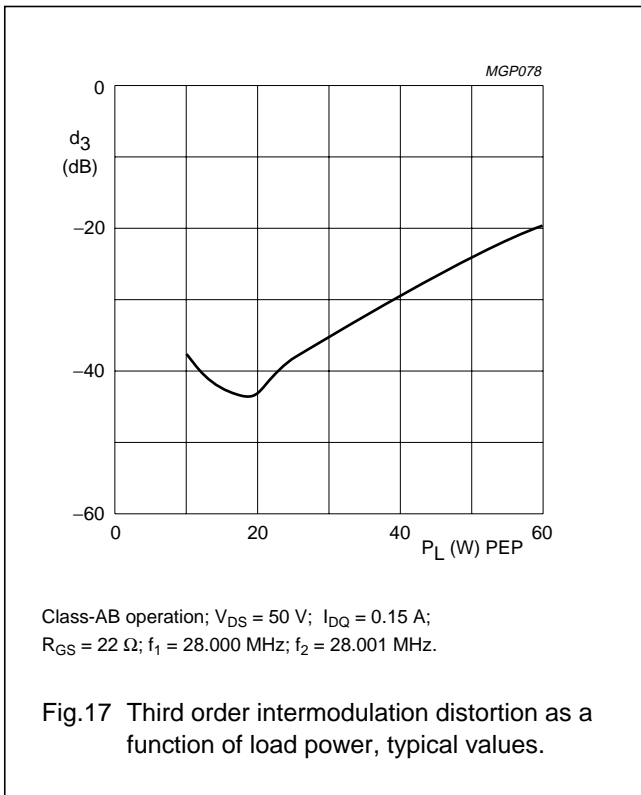

## HF/VHF power MOS transistor

BLF175

## List of components (class-AB test circuit)

COMPONENT	DESCRIPTION	VALUE	DIMENSIONS	CATALOGUE NO.
C1, C10	multilayer ceramic chip capacitor (note 1)	62 pF		
C2, C4, C8, C11	film dielectric trimmer	5 to 60 pF		2222 809 07011
C3	multilayer ceramic chip capacitor (note 1)	51 pF		
C5, C6, C9	multilayer ceramic chip capacitor	100 nF		2222 852 47104
C7	multilayer ceramic chip capacitor (note 1)	10 pF		
C12	aluminium electrolytic capacitor	10 $\mu$ F, 63 V		2222 030 28109
L1	9 turns enamelled 1 mm copper wire	280 nH	length 11 mm; int. dia. 6 mm; leads 2 x 4 mm	
L2, L3	stripline (note 2)	30 $\Omega$	length 10 mm; width 6 mm	
L4	14 turns enamelled 1 mm copper wire	1650 nH	length 20 mm; int. dia. 12 mm; leads 2 x 2 mm	
L5	10 turns enamelled 1 mm copper wire	380 nH	length 13 mm; int. dia. 7 mm; leads 2 x 3 mm	
L6	grade 3B Ferroxcube wideband RF choke			4312 020 36640
R1	0.4 W metal film resistor	22 $\Omega$		
R2	0.4 W metal film resistor	1 M $\Omega$		
R3	0.4 W metal film resistor	10 $\Omega$		

## Notes

1. American Technical Ceramics (ATC) capacitor, type 100B or other capacitor of the same quality.
2. The striplines are on a double copper-clad printed circuit board, with PTFE fibre-glass dielectric ( $\epsilon_r = 4.5$ ), thickness 1.6 mm.

HF/VHF power MOS transistor

BLF175

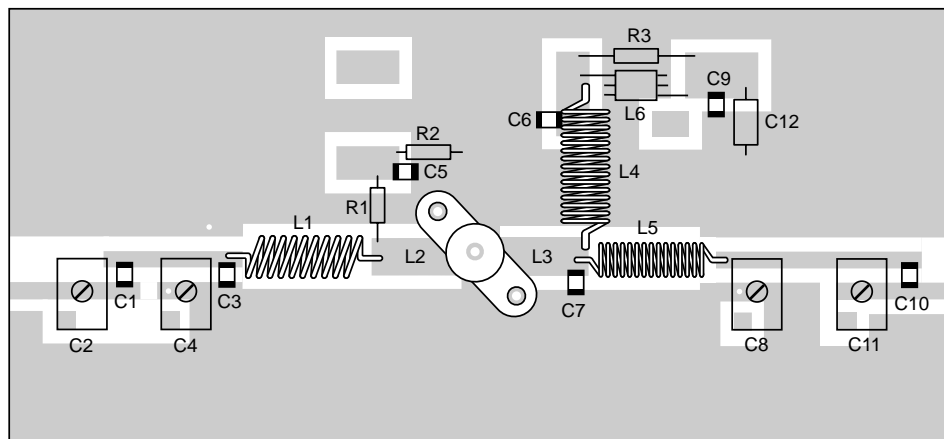
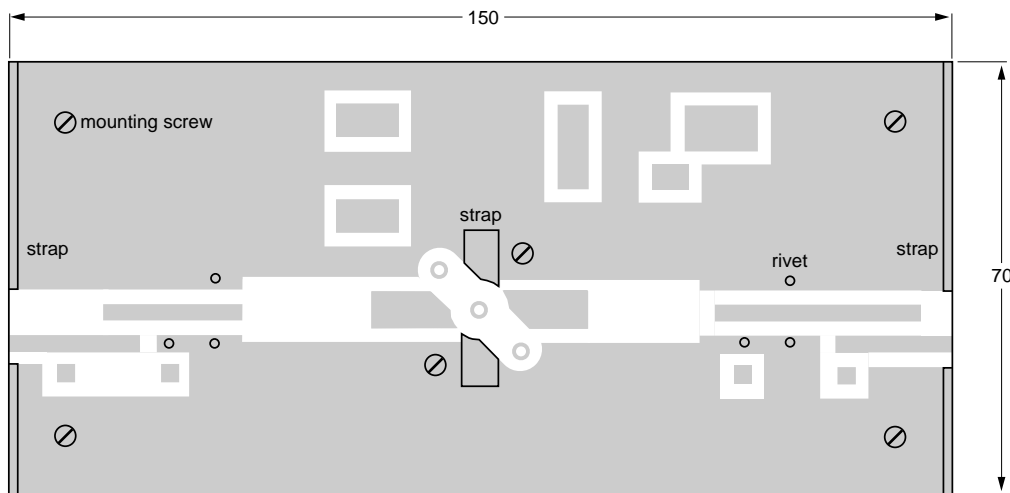

MGP081

Note: The circuit and components are situated on one side of the epoxy fibre-glass board, the other side being fully metallized to serve as earth. Earth connections are made by means of hollow rivets and straps at the two edges and under the source contacts.  
 Dimensions in mm.

Fig.20 Component layout for 28 MHz class-AB test circuit.

HF/VHF power MOS transistor

BLF175

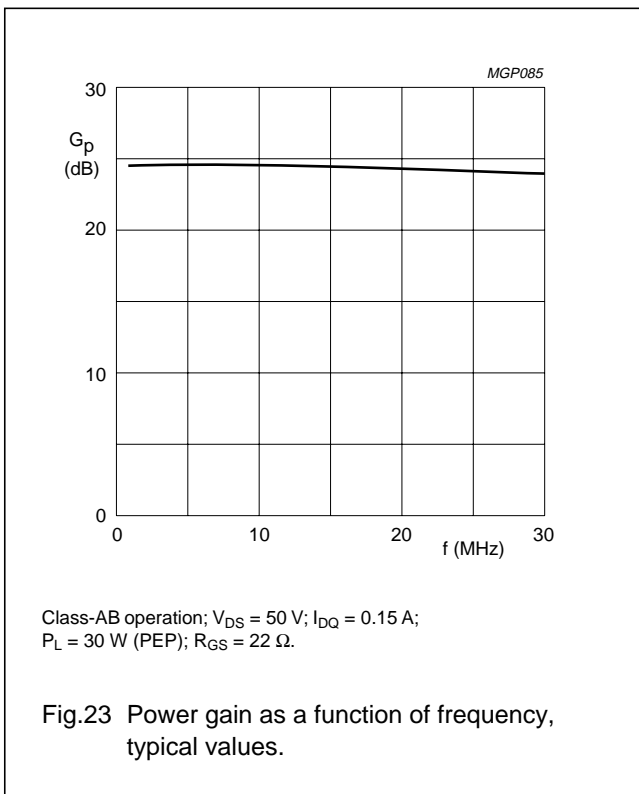
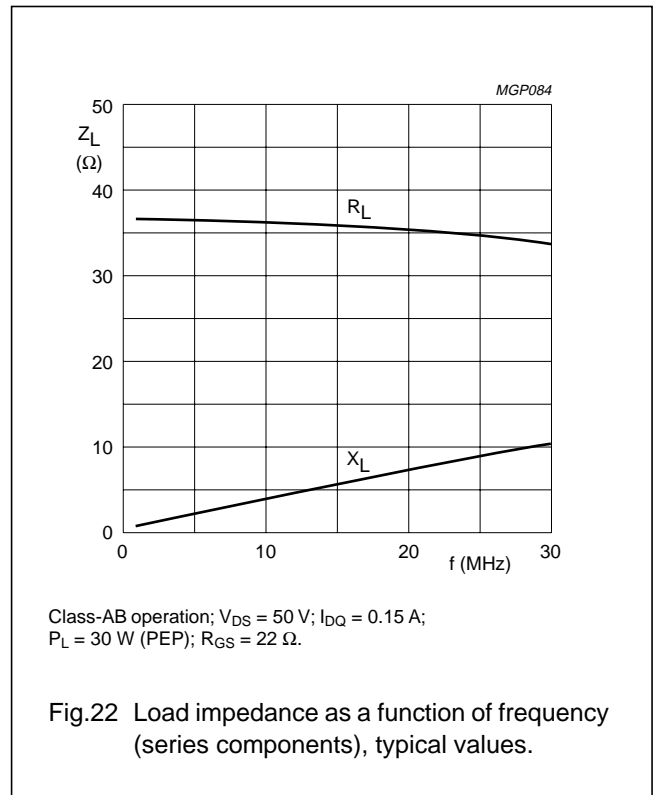
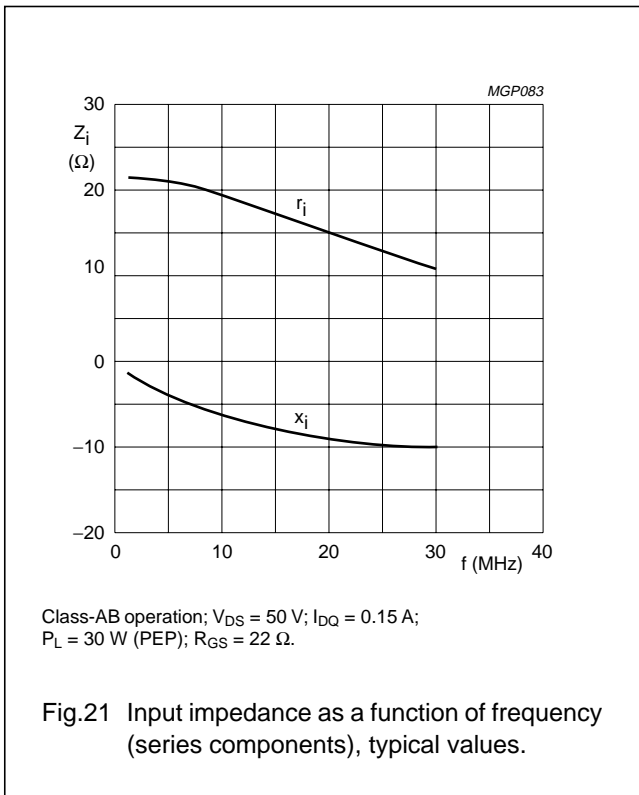

HF/VHF power MOS transistor

BLF175

APPLICATION INFORMATION FOR CLASS-AB OPERATION

RF performance in SSB operation in a common source circuit.

MODE OF OPERATION	f (MHz)	V <sub>DS</sub> (V)	I <sub>DQ</sub> (mA)	P <sub>L</sub> (W)	G <sub>P</sub> (dB)	η <sub>D</sub> (%)	R <sub>GS</sub> (Ω)
CW, class-B	108	50	30	30	typ. 20	typ. 65	10

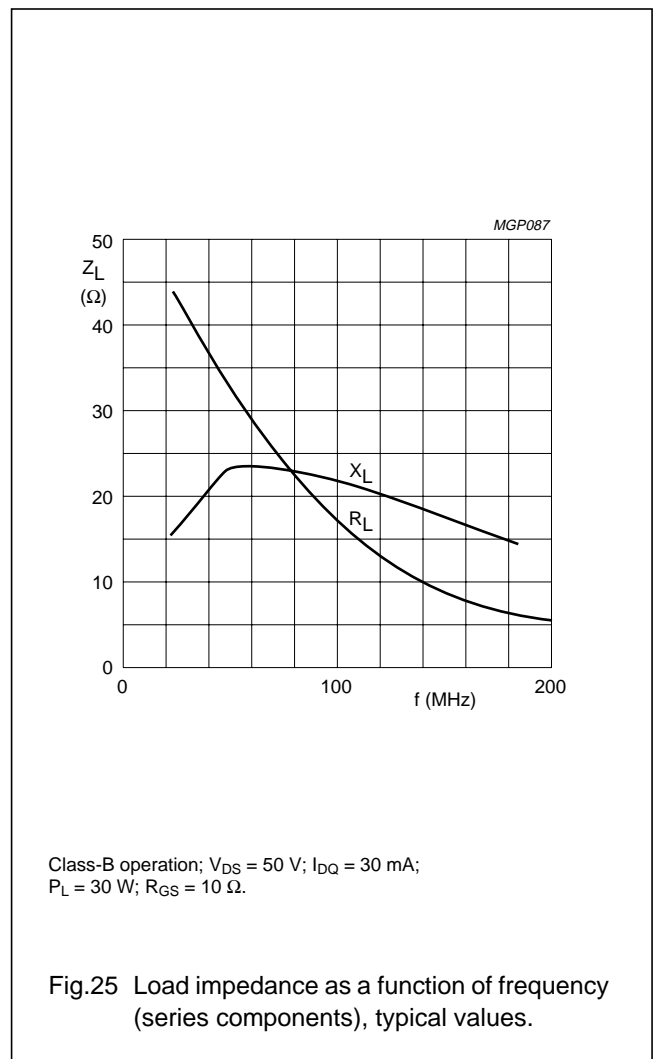
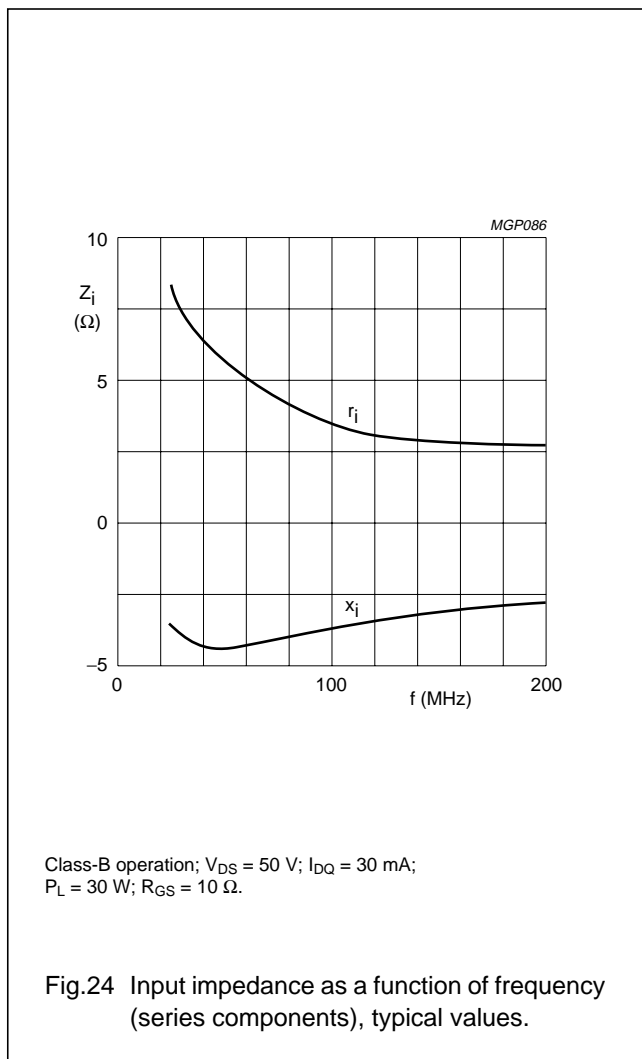

HF/VHF power MOS transistor

BLF175

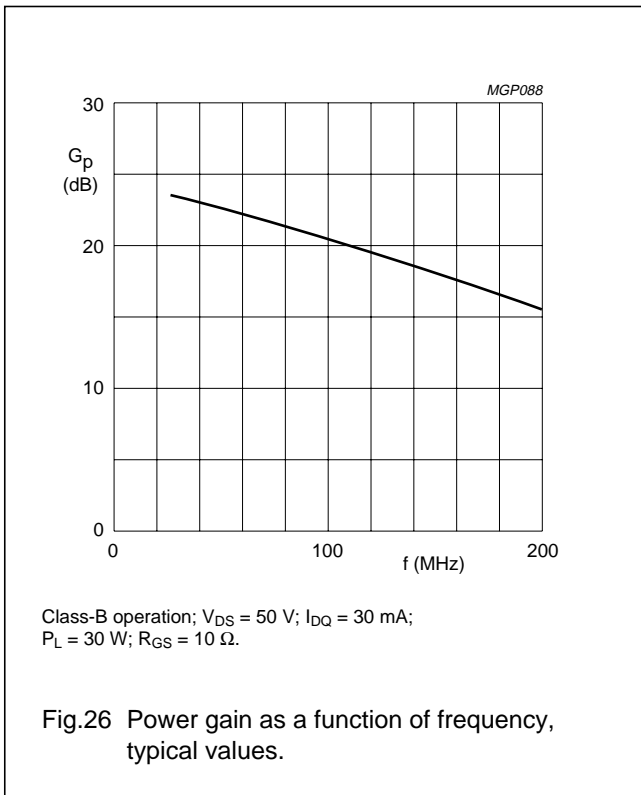



HF/VHF power MOS transistor

BLF175

PACKAGE OUTLINE

Flanged ceramic package; 2 mounting holes; 4 leads

SOT123A

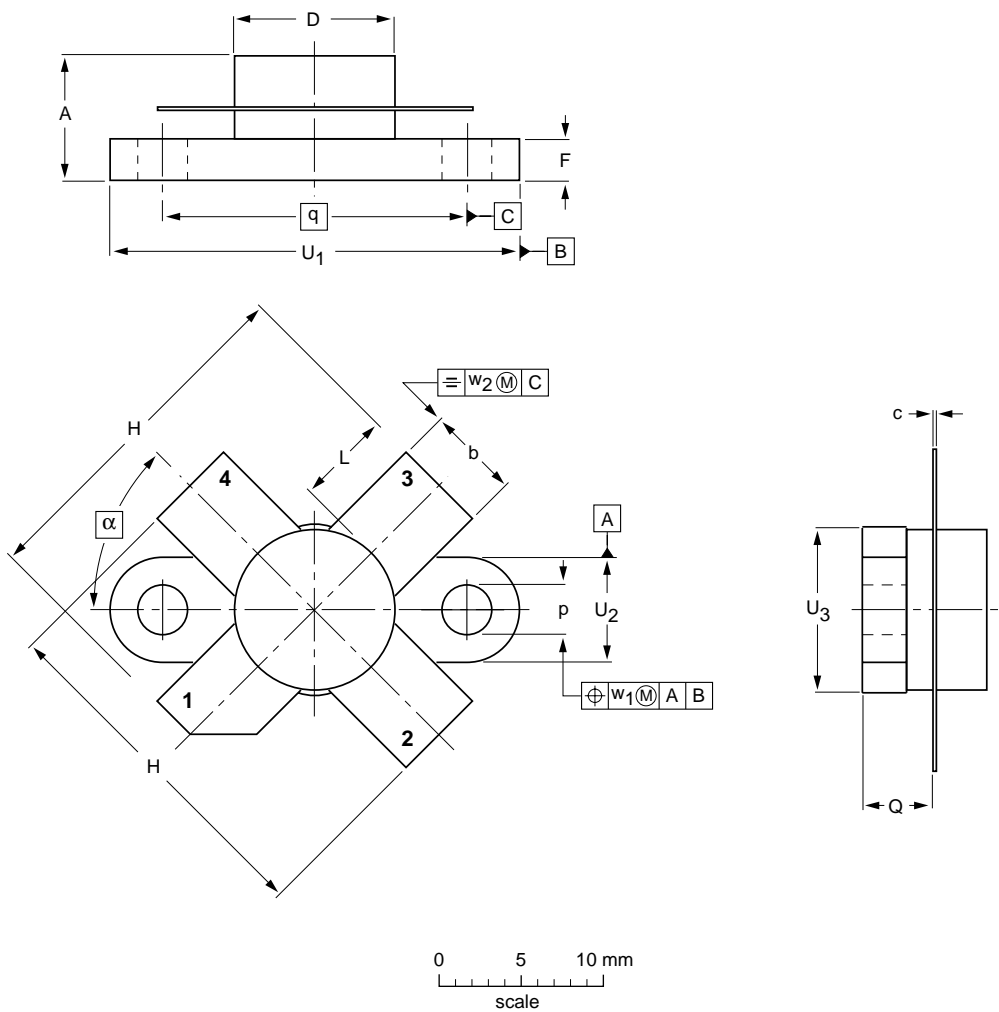

DIMENSIONS (millimetre dimensions are derived from the original inch dimensions)

UNIT	A	b	c	D	D <sub>1</sub>	F	H	L	p	Q	q	U <sub>1</sub>	U <sub>2</sub>	U <sub>3</sub>	w <sub>1</sub>	w <sub>2</sub>	α
mm	7.47 6.37	5.82 5.56	0.18 0.10	9.73 9.47	9.63 9.42	2.72 2.31	20.71 19.93	5.61 5.16	3.33 3.04	4.63 4.11	18.42	25.15 24.38	6.61 6.09	9.78 9.39	0.51	1.02	45°
inches	0.294 0.251	0.229 0.219	0.007 0.004	0.383 0.373	0.397 0.371	0.107 0.091	0.815 0.785	0.221 0.203	0.131 0.120	0.182 0.162	0.725	0.99 0.96	0.26 0.24	0.385 0.370	0.02	0.04	

OUTLINE VERSION	REFERENCES				EUROPEAN PROJECTION	ISSUE DATE
	IEC	JEDEC	EIAJ			
SOT123A						97-06-28

## HF/VHF power MOS transistor

BLF175

**DEFINITIONS**

<b>Data Sheet Status</b>	
Objective specification	This data sheet contains target or goal specifications for product development.
Preliminary specification	This data sheet contains preliminary data; supplementary data may be published later.
Product specification	This data sheet contains final product specifications.
<b>Limiting values</b>	
Limiting values given are in accordance with the Absolute Maximum Rating System (IEC 134). Stress above one or more of the limiting values may cause permanent damage to the device. These are stress ratings only and operation of the device at these or at any other conditions above those given in the Characteristics sections of the specification is not implied. Exposure to limiting values for extended periods may affect device reliability.	
<b>Application information</b>	
Where application information is given, it is advisory and does not form part of the specification.	

**LIFE SUPPORT APPLICATIONS**

These products are not designed for use in life support appliances, devices, or systems where malfunction of these products can reasonably be expected to result in personal injury. Philips customers using or selling these products for use in such applications do so at their own risk and agree to fully indemnify Philips for any damages resulting from such improper use or sale.