

## P-Channel Enhancement Mode MOSFET

### Features

- 40V/-45A,  
 $R_{DS(ON)} = 13m\Omega$  (typ.) @  $V_{GS} = -10V$   
 $R_{DS(ON)} = 19m\Omega$  (typ.) @  $V_{GS} = -4.5V$
- Super High Dense Cell Design
- Reliable and Rugged
- Lead Free and Green Devices Available (RoHS Compliant)

### Applications

- Power Management in LCD TV Inverter

### Pin Description

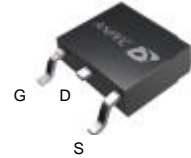

Top View of TO-252

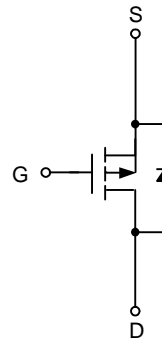

P-Channel MOSFET

### Ordering and Marking Information

<p>APM4015P □□-□□ □</p> <ul style="list-style-type: none"> <li>└─ Assembly Material</li> <li>└─ Handling Code</li> <li>└─ Temp. Range</li> <li>└─ Package Code</li> </ul>	<p>Package Code U : TO-252</p> <p>Operating Junction Temp. Range C : -55 to 150°C</p> <p>Handling Code TR : Tape &amp; Reel</p> <p>Assembly Material L : Lead Free Device G : Halogen and Lead Free Device</p>
<p>APM4015P U :</p> <div style="border: 1px solid black; padding: 2px; display: inline-block;">  <p>APM4015P XXXXX</p> </div>	<p>XXXXX - Date Code</p>

Note: ANPEC lead-free products contain molding compounds/die attach materials and 100% matte tin plate termination finish; which are fully compliant with RoHS. ANPEC lead-free products meet or exceed the lead-free requirements of IPC/JEDEC J-STD-020C for MSL classification at lead-free peak reflow temperature. ANPEC defines "Green" to mean lead-free (RoHS compliant) and halogen free (Br or Cl does not exceed 900ppm by weight in homogeneous material and total of Br and Cl does not exceed 1500ppm by weight).

ANPEC reserves the right to make changes to improve reliability or manufacturability without notice, and advise customers to obtain the latest version of relevant information to verify before placing orders.

## Absolute Maximum Ratings

Symbol	Parameter	Rating	Unit
<b>Common Ratings</b> ( $T_A=25^\circ\text{C}$ Unless Otherwise Noted)			
$V_{DSS}$	Drain-Source Voltage	-40	V
$V_{GSS}$	Gate-Source Voltage	$\pm 20$	
$T_J$	Maximum Junction Temperature	150	$^\circ\text{C}$
$T_{STG}$	Storage Temperature Range	-55 to 150	$^\circ\text{C}$
$I_S^*$	Diode Continuous Forward Current	$T_C=25^\circ\text{C}$ -20	A
$I_{DP}^*$	300 $\mu\text{s}$ Pulse Drain Current Tested	$T_C=25^\circ\text{C}$ -90	A
		$T_C=100^\circ\text{C}$ -60	
$I_D^*$	Continuous Drain Current	$T_C=25^\circ\text{C}$ -45	A
		$T_C=100^\circ\text{C}$ -30	
$P_D^*$	Maximum Power Dissipation	$T_C=25^\circ\text{C}$ 50	W
		$T_C=100^\circ\text{C}$ 20	
$R_{\theta JC}^*$	Thermal Resistance-Junction to Case	2.5	$^\circ\text{C/W}$
$R_{\theta JA}^*$	Thermal Resistance-Junction to Ambient	50	$^\circ\text{C/W}$

Notes:

\* Surface Mounted on 1in<sup>2</sup> pad area,  $t \leq 10$  sec.

## Electrical Characteristics ( $T_A = 25^\circ\text{C}$ unless otherwise noted)

Symbol	Parameter	Test Condition	APM4015PU			Unit
			Min.	Typ.	Max.	
<b>Static Characteristics</b>						
$BV_{DSS}$	Drain-Source Breakdown Voltage	$V_{GS}=0V, I_{DS}=-250\mu\text{A}$	-40			V
$I_{DSS}$	Zero Gate Voltage Drain Current	$V_{DS}=-32V, V_{GS}=0V$ $T_J=85^\circ\text{C}$			-1	$\mu\text{A}$
					-30	
$V_{GS(th)}$	Gate Threshold Voltage	$V_{DS}=V_{GS}, I_{DS}=-250\mu\text{A}$	-1.3	-2	-2.5	V
$I_{GSS}$	Gate Leakage Current	$V_{GS}=\pm 20V, V_{DS}=0V$			$\pm 100$	nA
$R_{DS(ON)}^a$	Drain-Source On-state Resistance	$V_{GS}=-10V, I_{DS}=-20A$		13	16	m $\Omega$
		$V_{GS}=-4.5V, I_{DS}=-10A$		19	25	
<b>Diode Characteristics</b>						
$V_{SD}^a$	Diode Forward Voltage	$I_{SD}=-20A, V_{GS}=0V$		-0.75	-1.1	V
$t_{rr}$	Reverse Recovery Time	$I_{SD}=-20A, dI_{SD}/dt=100A/\mu\text{s}$		28		ns
$Q_{rr}$	Reverse Recovery Charge			26		nC

## Electrical Characteristics (Cont.) (T<sub>A</sub> = 25°C unless otherwise noted)

Symbol	Parameter	Test Condition	APM4015PU			Unit
			Min.	Typ.	Max.	
<b>Dynamic Characteristics<sup>b</sup></b>						
R <sub>G</sub>	Gate Resistance	V <sub>GS</sub> =0V, V <sub>DS</sub> =0V, F=1MHz		4		Ω
C <sub>iss</sub>	Input Capacitance	V <sub>GS</sub> =0V, V <sub>DS</sub> =-20V, Frequency=1.0MHz		2800		pF
C <sub>oss</sub>	Output Capacitance			320		
C <sub>rss</sub>	Reverse Transfer Capacitance			220		
t <sub>d(ON)</sub>	Turn-on Delay Time	V <sub>DD</sub> =-20V, R <sub>L</sub> =20Ω, I <sub>DS</sub> =-1A, V <sub>GEN</sub> =-10V, R <sub>G</sub> =6Ω		11	21	ns
t <sub>r</sub>	Turn-on Rise Time			75	135	
t <sub>d(OFF)</sub>	Turn-off Delay Time			89	161	
t <sub>f</sub>	Turn-off Fall Time			35	64	
<b>Gate Charge Characteristics<sup>b</sup></b>						
Q <sub>g</sub>	Total Gate Charge	V <sub>DS</sub> =-20V, V <sub>GS</sub> =-10V, I <sub>DS</sub> =-20A		40	56	nC
Q <sub>gs</sub>	Gate-Source Charge			6		
Q <sub>gd</sub>	Gate-Drain Charge			12		

Notes:

- a : Pulse test ; pulse width ≤ 300μs, duty cycle ≤ 2%.
- b : Guaranteed by design, not subject to production testing.

Typical Characteristics

Power Dissipation

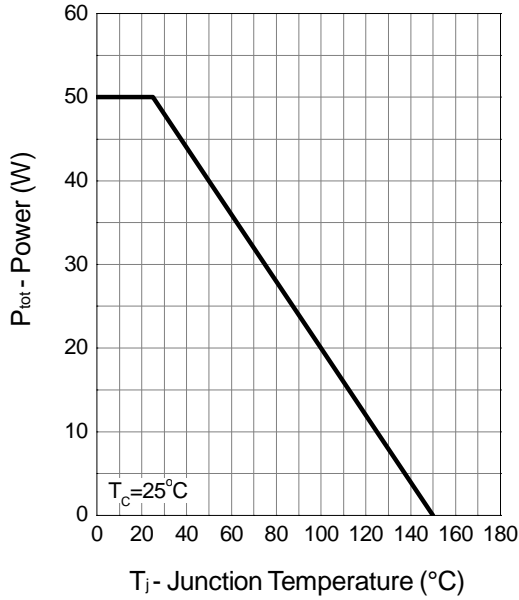

Drain Current

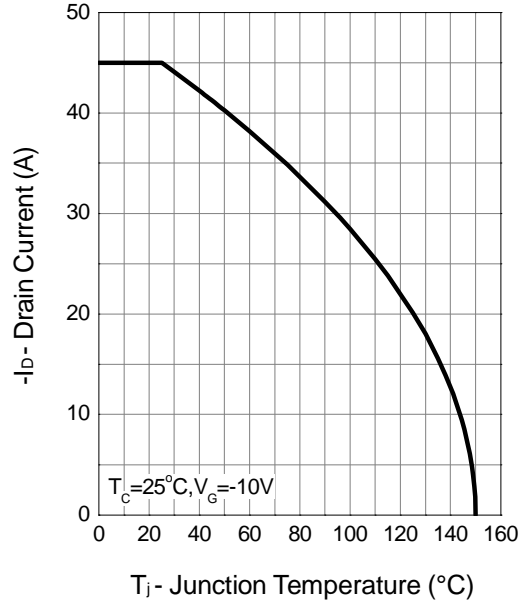

Safe Operation Area

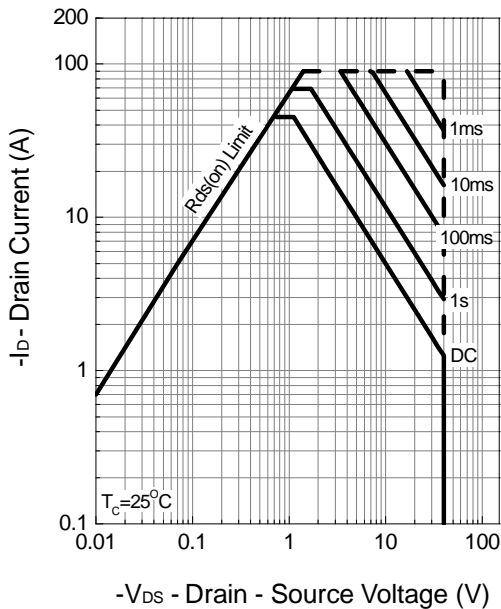

Thermal Transient Impedance

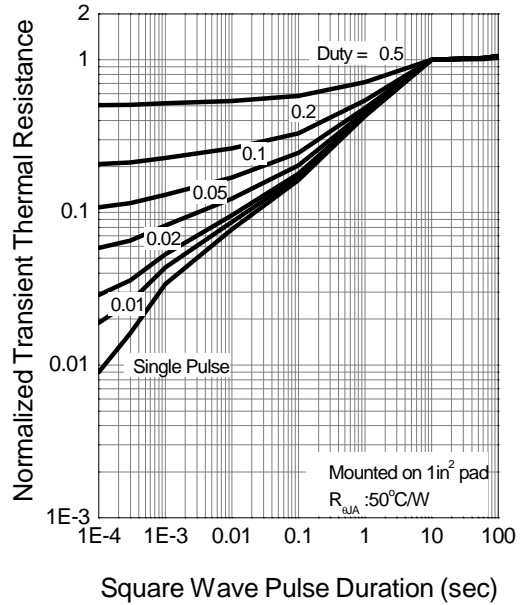

Typical Characteristics (Cont.)

Output Characteristics

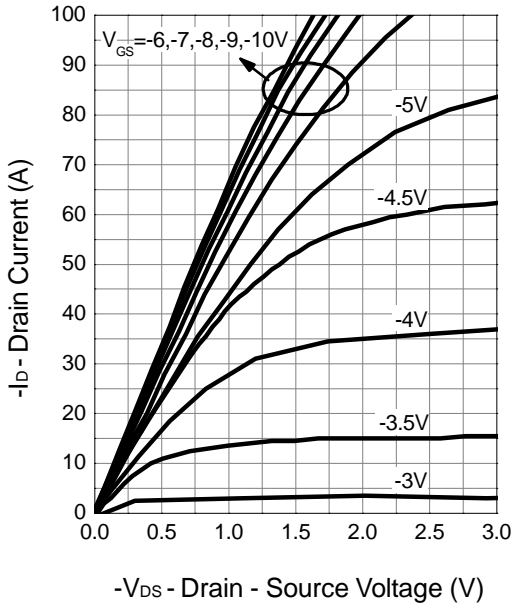

Drain-Source On Resistance

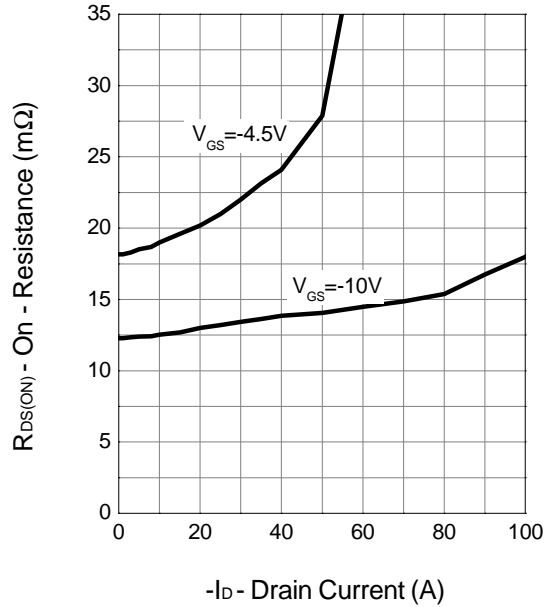

Drain-Source On Resistance

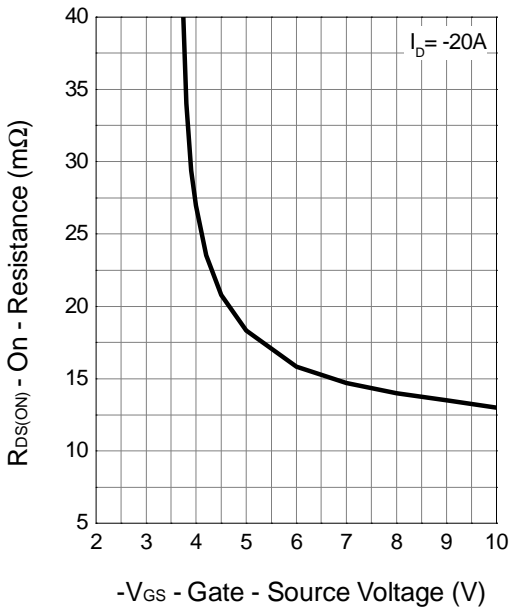

Gate Threshold Voltage

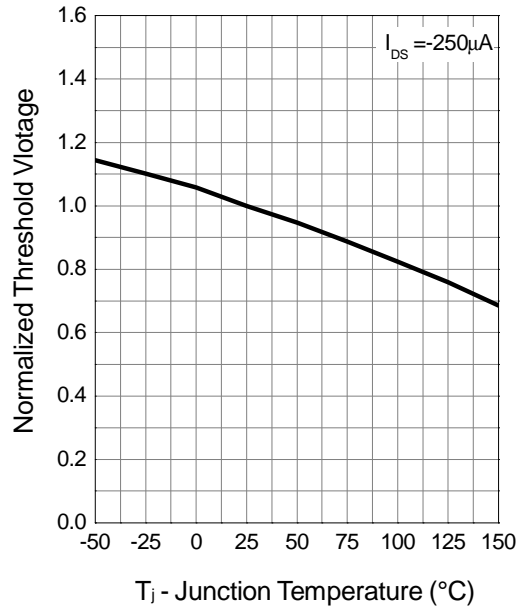

Typical Characteristics (Cont.)

Drain-Source On Resistance

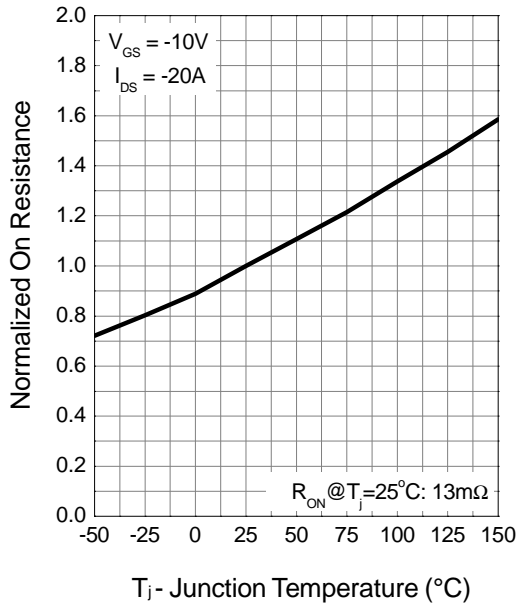

Source-Drain Diode Forward

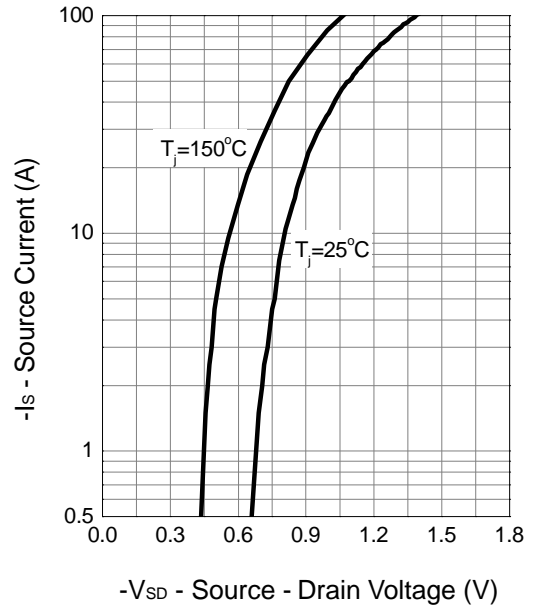

Capacitance

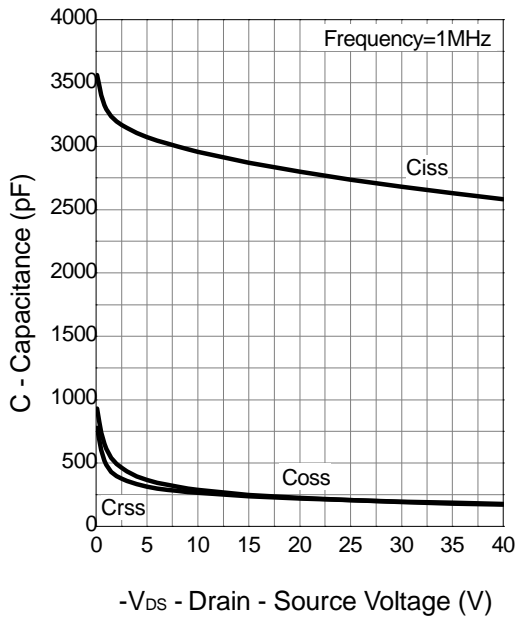

Gate Charge

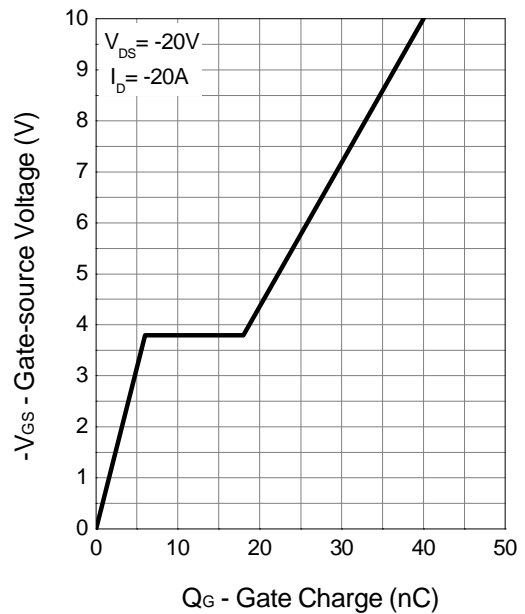

Package Information

TO-252

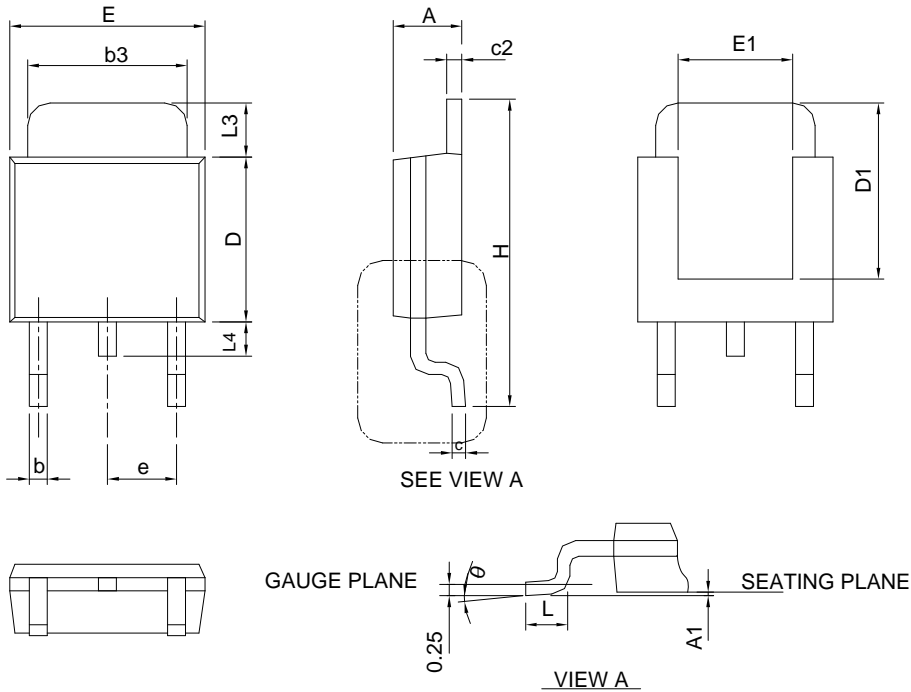

SYMBOL	TO-252			
	MILLIMETERS		INCHES	
	MIN.	MAX.	MIN.	MAX.
A	2.18	2.39	0.086	0.094
A1		0.13		0.005
b	0.50	0.89	0.020	0.035
b3	4.95	5.46	0.195	0.215
c	0.46	0.61	0.018	0.024
c2	0.46	0.89	0.018	0.035
D	5.33	6.22	0.210	0.245
D1	4.57	6.00	0.180	0.235
E	6.35	6.73	0.250	0.265
E1	3.81	6.00	0.150	0.235
e	2.29 BSC		0.090 BSC	
H	9.40	10.41	0.370	0.410
L	0.90	1.78	0.035	0.070
L3	0.89	2.03	0.035	0.080
L4		1.02		0.040
θ	0°	8°	0°	8°

Note : Follow JEDEC TO-252 .

### Carrier Tape & Reel Dimensions

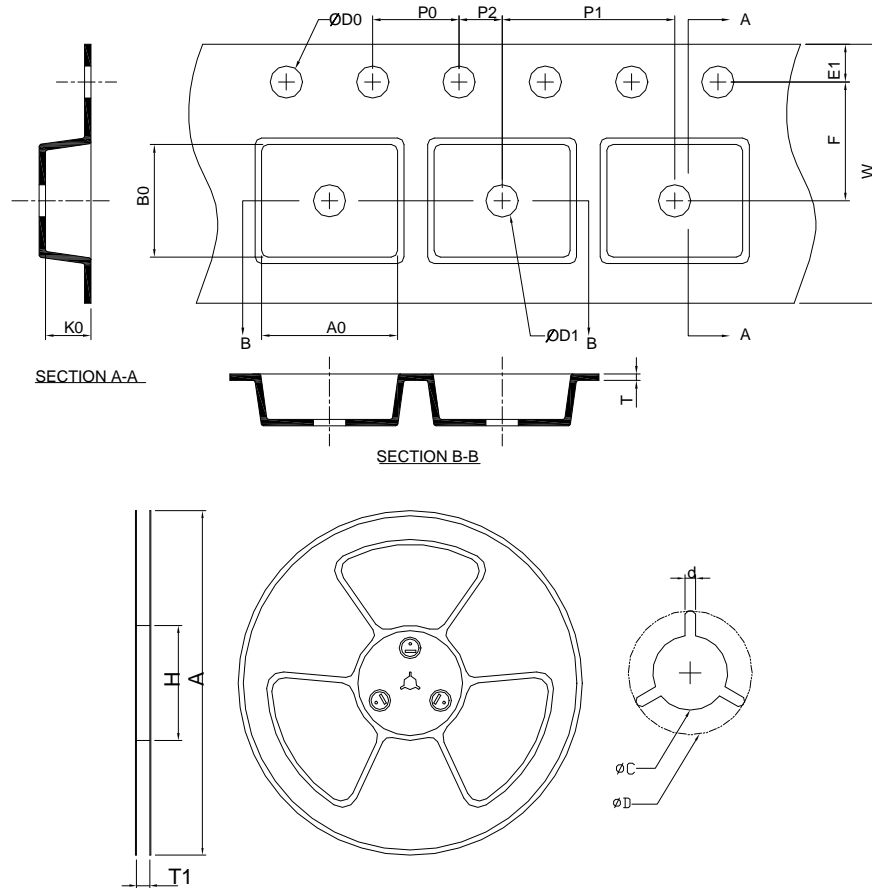

Application	A	H	T1	C	d	D	W	E1	F
TO-252	330.0 ±2.00	50 MIN.	16.4+2.00 0	13.0+0.50 -0.2	1.5 MIN.	20.2 MIN.	16.0 ±0.30	1.75 ±0.10	7.5 ±0.10
	<b>P0</b>	<b>P1</b>	<b>P2</b>	<b>D0</b>	<b>D1</b>	<b>T</b>	<b>A0</b>	<b>B0</b>	<b>K0</b>
	4.0 ±0.10	8.0 ±0.10	2.0 ±0.10	1.5 +0.10	1.5 MIN.	0.6 +0.00	6.8 ±0.20	10.4 ±0.20	2.5 ±0.20

(mm)

### Devices Per Unit

Package Type	Unit	Quantity
TO-252	Tape & Reel	2500



**Reflow Condition (IR/Convection or VPR Reflow)**

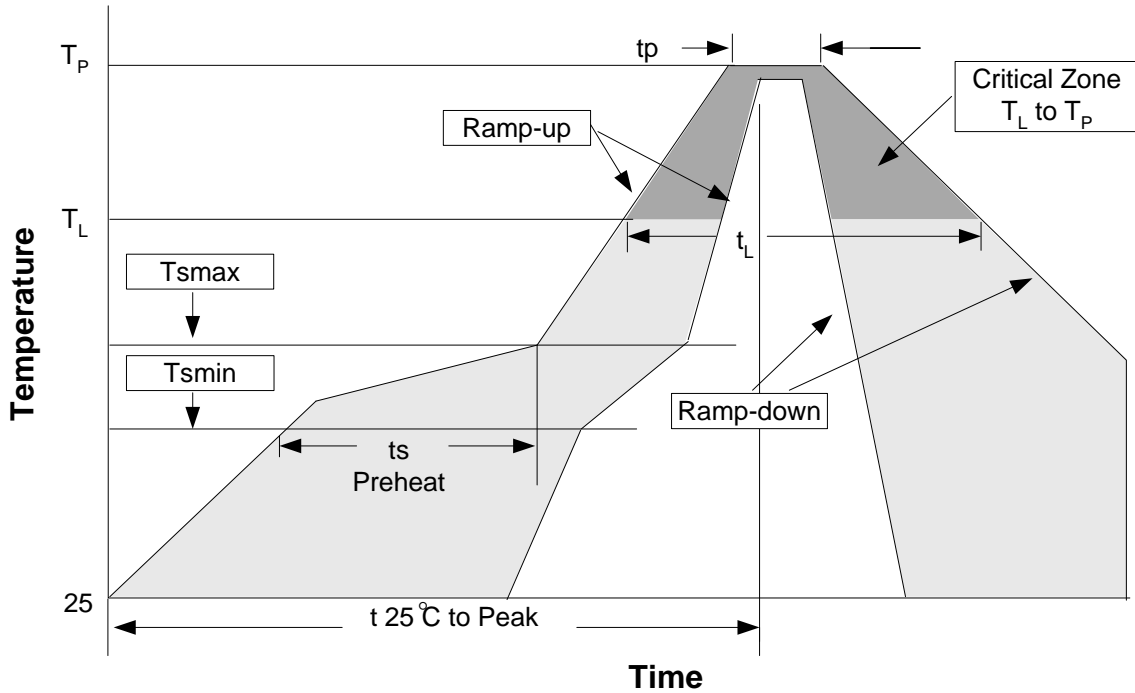

**Reliability Test Program**

Test item	Method	Description
SOLDERABILITY	MIL-STD-883D-2003	245°C, 5 sec
HOLT	MIL-STD-883D-1005.7	1000 Hrs Bias @125°C
PCT	JESD-22-B, A102	168 Hrs, 100%RH, 121°C
TST	MIL-STD-883D-1011.9	-65°C~150°C, 200 Cycles

**Classification Reflow Profiles**

Profile Feature	Sn-Pb Eutectic Assembly	Pb-Free Assembly
Average ramp-up rate (T <sub>L</sub> to T <sub>P</sub> )	3°C/second max.	3°C/second max.
Preheat		
- Temperature Min (T <sub>min</sub> )	100°C	150°C
- Temperature Max (T <sub>max</sub> )	150°C	200°C
- Time (min to max) (t <sub>s</sub> )	60-120 seconds	60-180 seconds
Time maintained above:		
- Temperature (T <sub>L</sub> )	183°C	217°C
- Time (t <sub>L</sub> )	60-150 seconds	60-150 seconds
Peak/Classification Temperature (T <sub>p</sub> )	See table 1	See table 2
Time within 5°C of actual Peak Temperature (t <sub>p</sub> )	10-30 seconds	20-40 seconds
Ramp-down Rate	6°C/second max.	6°C/second max.
Time 25°C to Peak Temperature	6 minutes max.	8 minutes max.

Note: All temperatures refer to topside of the package. Measured on the body surface.

## Classification Reflow Profiles (Cont.)

Table 1. SnPb Eutectic Process – Package Peak Reflow Temperatures

Package Thickness	Volume mm <sup>3</sup> <350	Volume mm <sup>3</sup> ≥350
<2.5 mm	240 +0/-5°C	225 +0/-5°C
≥2.5 mm	225 +0/-5°C	225 +0/-5°C

Table 2. Pb-free Process – Package Classification Reflow Temperatures

Package Thickness	Volume mm <sup>3</sup> <350	Volume mm <sup>3</sup> 350-2000	Volume mm <sup>3</sup> >2000
<1.6 mm	260 +0°C*	260 +0°C*	260 +0°C*
1.6 mm – 2.5 mm	260 +0°C*	250 +0°C*	245 +0°C*
≥2.5 mm	250 +0°C*	245 +0°C*	245 +0°C*

\*Tolerance: The device manufacturer/supplier **shall** assure process compatibility up to and including the stated classification temperature (this means Peak reflow temperature +0°C. For example 260°C+0°C) at the rated MSL level.

## Customer Service

### Anpec Electronics Corp.

Head Office :

No.6, Dusing 1st Road, SBIP,

Hsin-Chu, Taiwan, R.O.C.

Tel : 886-3-5642000

Fax : 886-3-5642050

Taipei Branch :

2F, No. 11, Lane 218, Sec 2 Jhongsing Rd.,

Sindain City, Taipei County 23146, Taiwan

Tel : 886-2-2910-3838

Fax : 886-2-2917-3838