

### IGBT MODULE (S series) 600V / 50A / PIM



#### ■ Features

- Low  $V_{CE(sat)}$
- Compact package
- P.C. board mount
- Converter diode bridge, Dynamic brake circuit

#### ■ Applications

- Inverter for motor drive
- AC and DC servo drive amplifier
- Uninterruptible power supply

#### ■ Maximum ratings and characteristics

● Absolute maximum ratings ( $T_c=25^\circ\text{C}$  unless without specified)

Item	Symbol	Condition	Rating	Unit	
Inverter	Collector-Emitter voltage	$V_{CES}$	600	V	
	Gate-Emitter voltage	$V_{GES}$	$\pm 20$	V	
	Collector current	$I_C$	Continuous	50	A
		$I_{CP}$	1ms	100	A
		$-I_C$		50	A
Collector power dissipation	$P_C$	1 device	200	W	
Brake	Collector-Emitter voltage	$V_{CES}$	600	V	
	Gate-Emitter voltage	$V_{GES}$	$\pm 20$	V	
	Collector current	$I_C$	Continuous	30	A
		$I_{CP}$	1ms	60	A
	Collector power dissipation	$P_C$	1 device	120	W
Converter	Repetitive peak reverse voltage	$V_{RRM}$	600	V	
	Repetitive peak reverse voltage	$V_{RRM}$	800	V	
	Average output current	$I_O$	50Hz/60Hz sine wave	50	A
	Surge current (Non-Repetitive)	$I_{FSM}$	$T_j=150^\circ\text{C}$ , 10ms	350	A
	$I^2t$ (Non-Repetitive)	$I^2t$	half sine wave	613	$\text{A}^2\text{s}$
Operating junction temperature	$T_j$		+150	$^\circ\text{C}$	
Storage temperature	$T_{stg}$		-40 to +125	$^\circ\text{C}$	
Isolation between terminal and copper base *2	$V_{iso}$	AC : 1 minute	AC 2500	V	
			AC 2500	V	
Mounting screw torque			3.5 *1	N·m	

\*1 Recommendable value : 2.5 to 3.5 N·m (M5)

\*2 All terminals should be connected together when isolation test will be done.

\*3 Terminal 8 and 9 should be connected together. Terminal 1 to 7 and 10 to 24 should be connected together and shorted to copper base.

## ● Electrical characteristics (T<sub>j</sub>=25°C unless otherwise specified)

Item	Symbol	Condition	Characteristics			Unit		
			Min.	Typ.	Max.			
Inverter	Zero gate voltage collector current	ICES	V <sub>CE</sub> =600V, V <sub>GE</sub> =0V		1.0	mA		
	Gate-Emitter leakage current	IGES	V <sub>CE</sub> =0V, V <sub>GE</sub> =±20V		0.2	μA		
	Gate-Emitter threshold voltage	V <sub>GE(th)</sub>	V <sub>CE</sub> =20V, I <sub>c</sub> =50mA		5.5	7.8	8.5	V
	Collector-Emitter saturation voltage	V <sub>CE(sat)</sub>	V <sub>GE</sub> =15V, I <sub>c</sub> =50A	chip	1.8		V	
				terminal	1.95	2.4		
	Input capacitance	C <sub>ies</sub>	V <sub>GE</sub> =0V, V <sub>CE</sub> =10V, f=1MHz		5000		pF	
	Turn-on time	ton	V <sub>CC</sub> =300V		0.45	1.2	μs	
		tr	I <sub>c</sub> =50A		0.25	0.6		
		tr(i)	V <sub>GE</sub> =±15V		0.08			
	Turn-off	toff	R <sub>G</sub> =51Ω		0.40	1.0		
tf				0.05	0.35			
Forward on voltage	V <sub>F</sub>	I <sub>F</sub> =50A	chip	1.75		V		
			terminal	1.9	2.6			
Reverse recovery time of FRD	t <sub>rr</sub>	I <sub>F</sub> =50A			0.3	μs		
Brake	Zero gate voltage collector current	ICES	V <sub>CEs</sub> =600V, V <sub>GE</sub> =0V		1.0	mA		
	Gate-Emitter leakage current	IGES	V <sub>CE</sub> =0V, V <sub>GE</sub> =±20V		0.2	μA		
	Collector-Emitter saturation voltage	V <sub>CE(sat)</sub>	I <sub>c</sub> =30A, V <sub>GE</sub> =15V	chip	1.8		V	
				terminal	1.95	2.4		
	Turn-on time	ton	V <sub>CC</sub> =300V		0.45	1.2	μs	
		tr	I <sub>c</sub> =30A		0.25	0.6		
	Turn-off time	toff	V <sub>GE</sub> =±15V		0.40	1.0		
		tf	R <sub>G</sub> =82Ω		0.05	0.35		
	Reverse current	I <sub>RRM</sub>	V <sub>R</sub> =600V			1.0	mA	
	Converter	Forward on voltage	V <sub>FM</sub>	I <sub>F</sub> =50A	chip	1.1	V	
terminal					1.2	1.5		
Reverse current	I <sub>RRM</sub>	V <sub>R</sub> =800V			1.0	mA		
Thermistor	Resistance	R	T=25°C		5000	Ω		
			T=100°C		465		495	520
	B value	B	T=25/50°C		3305	3375	3450	K

## ● Thermal resistance Characteristics

Item	Symbol	Condition	Characteristics			Unit
			Min.	Typ.	Max.	
Thermal resistance ( 1 device )	R <sub>th(j-c)</sub>	Inverter IGBT			0.63	°C/W
		Inverter FWD			1.33	
		Brake IGBT			1.04	
		Converter Diode			0.90	
Contact thermal resistance *	R <sub>th(c-f)</sub>	With thermal compound		0.05		

\* This is the value which is defined mounting on the additional cooling fin with thermal compound

## ■ Equivalent Circuit Schematic

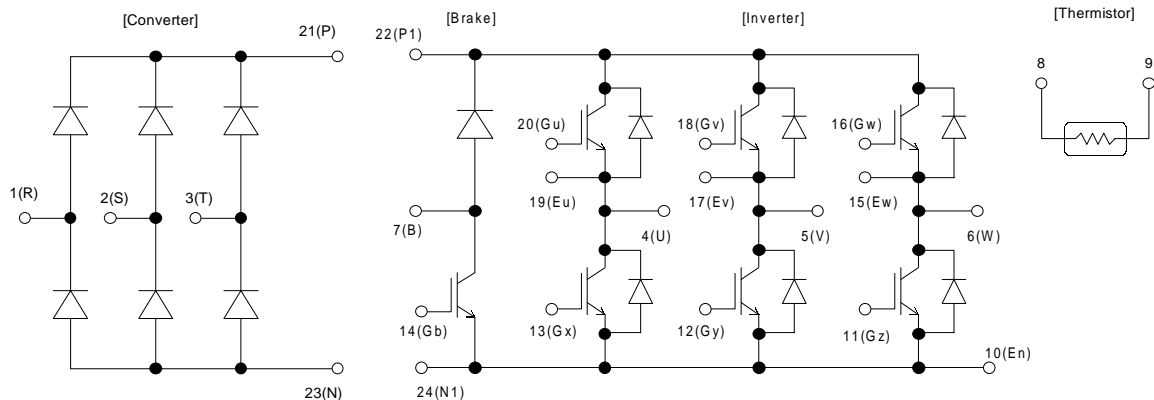

## Characteristics (Representative)

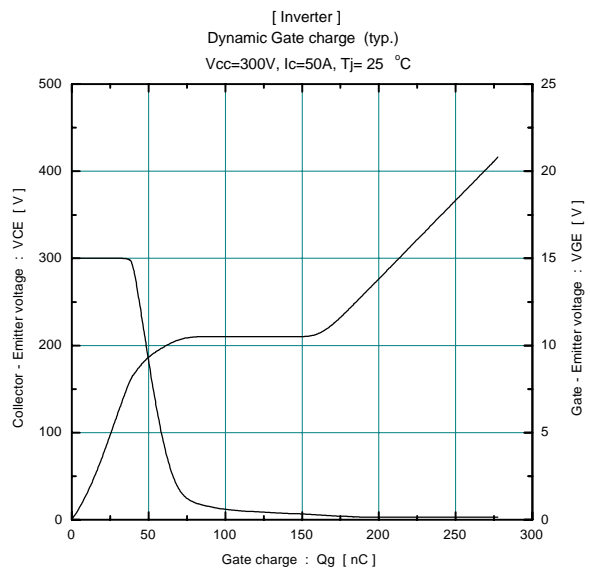
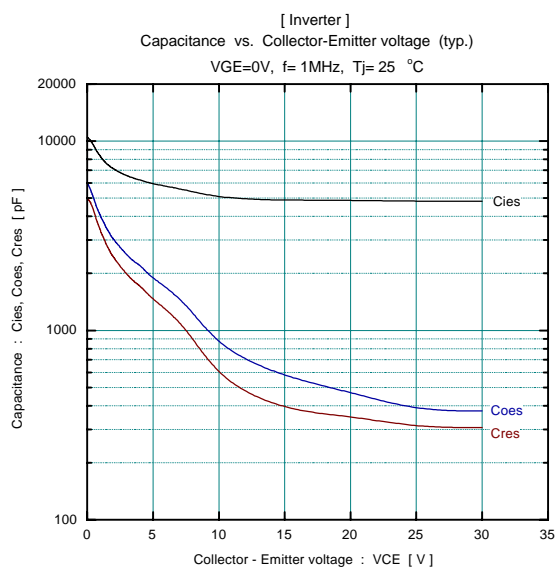
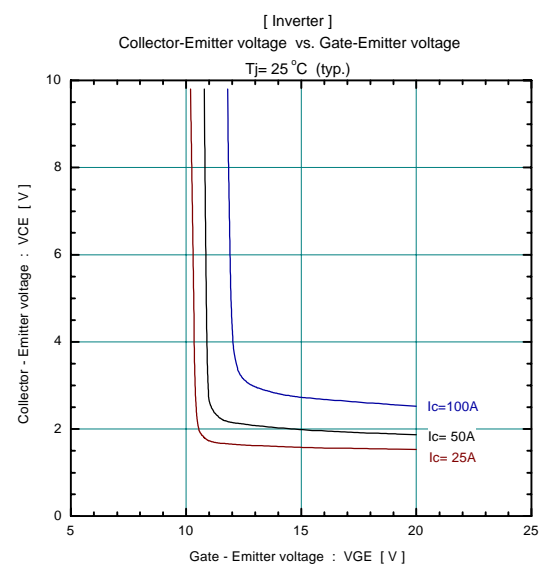
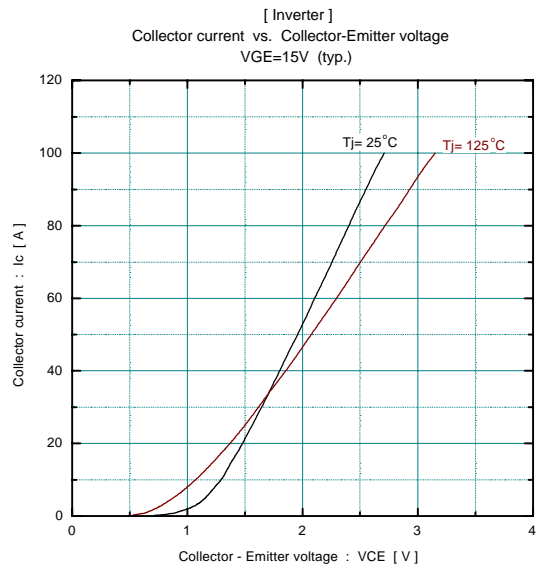
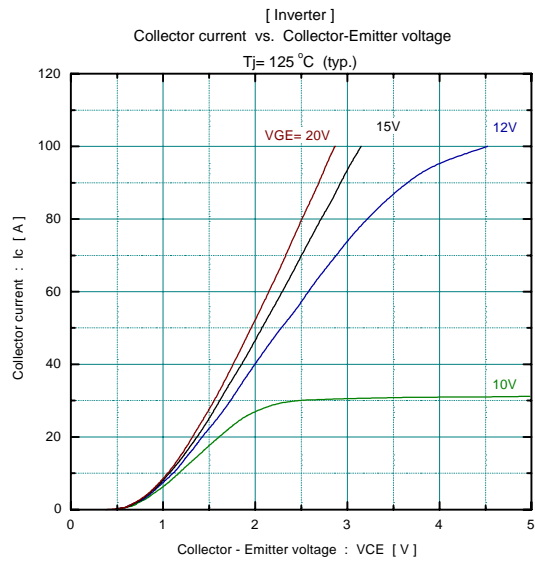
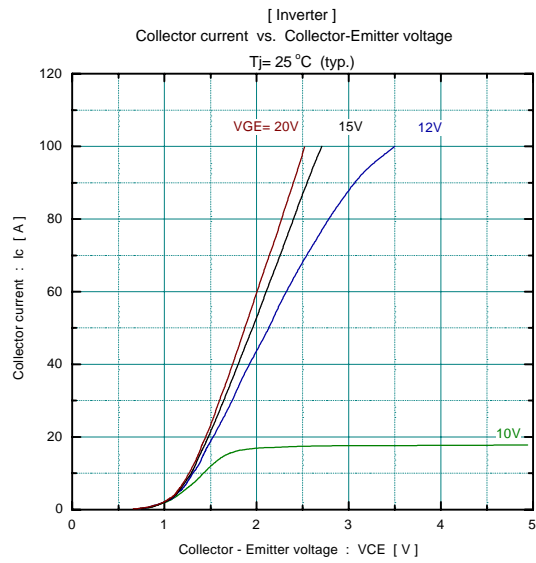

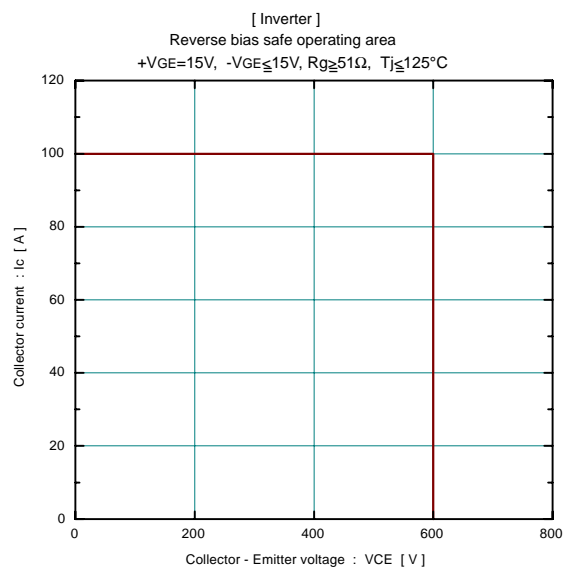
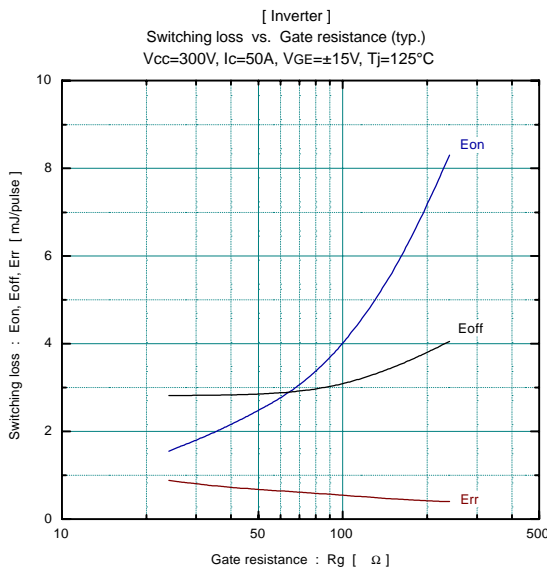
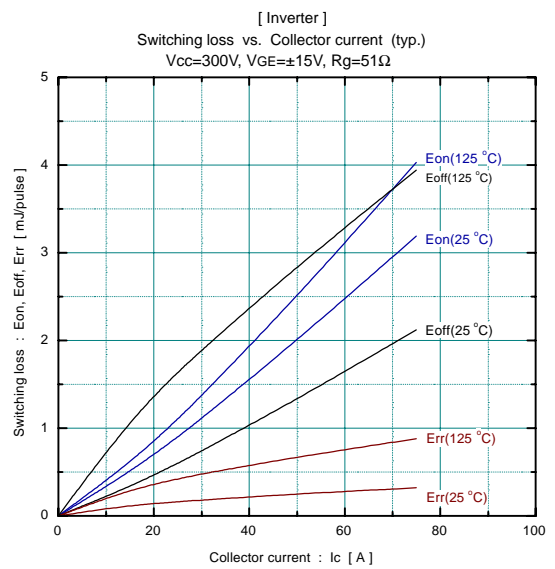
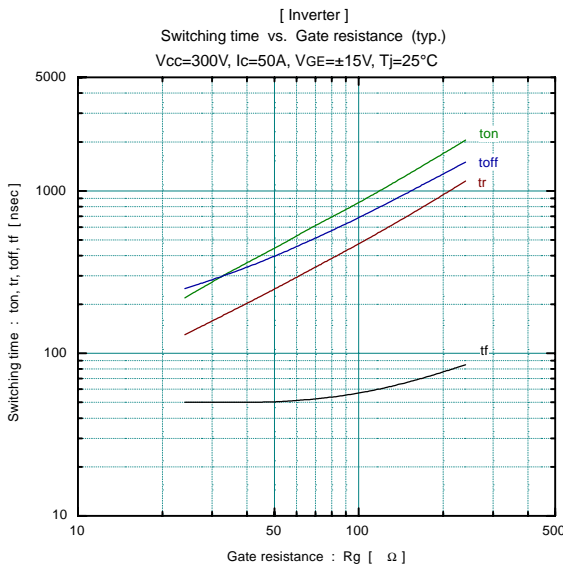
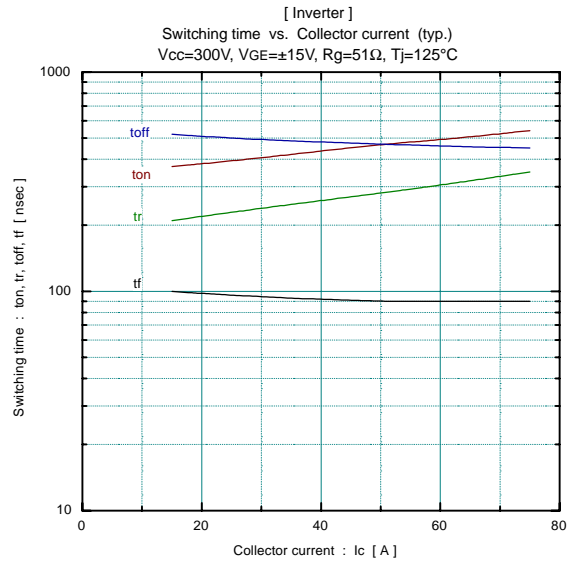
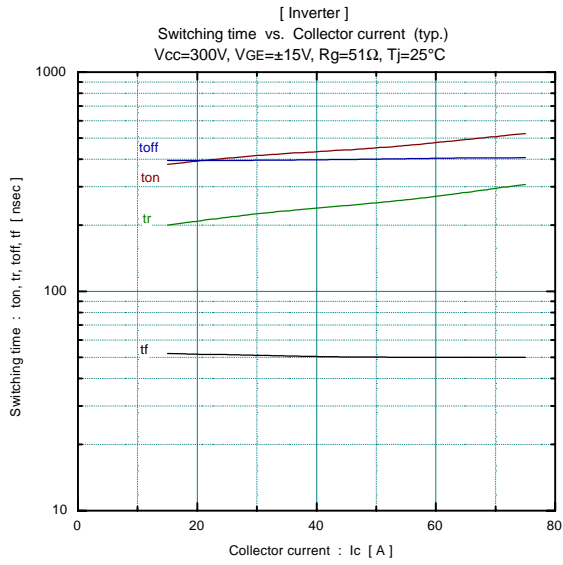

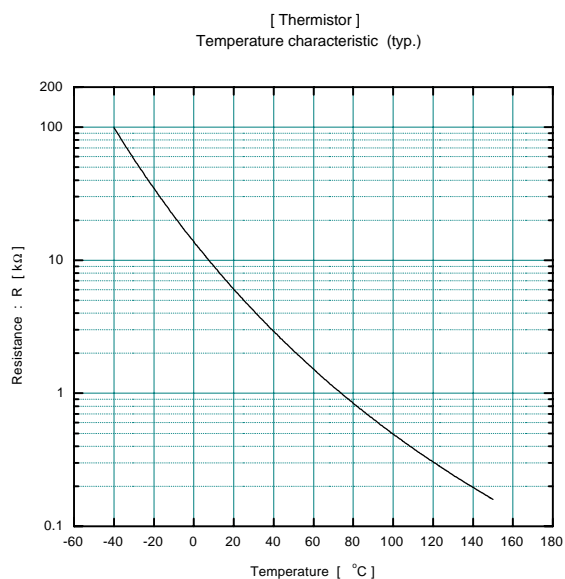
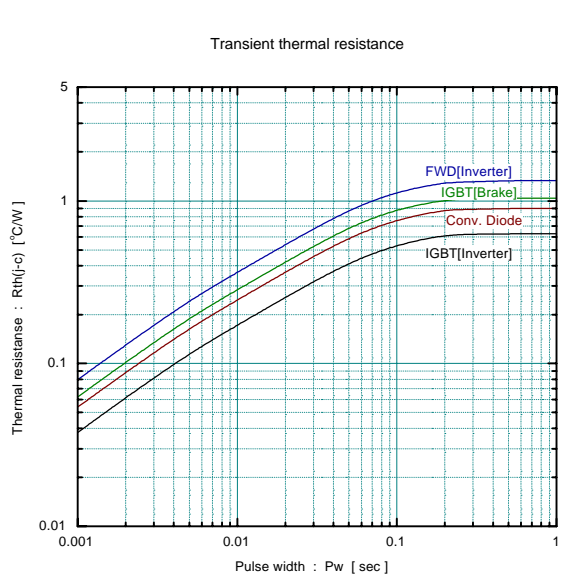
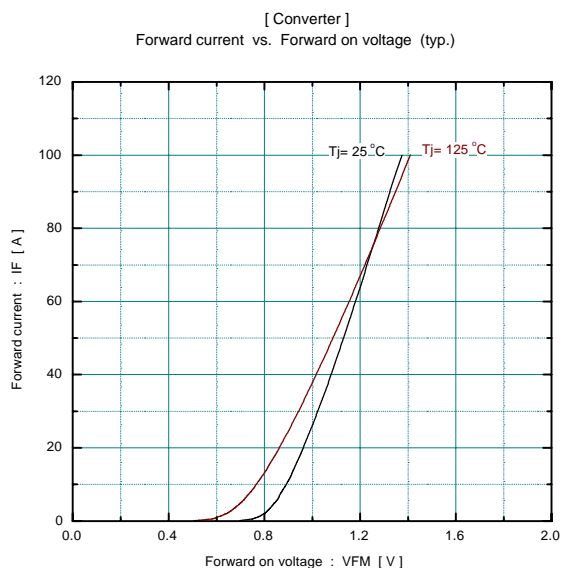
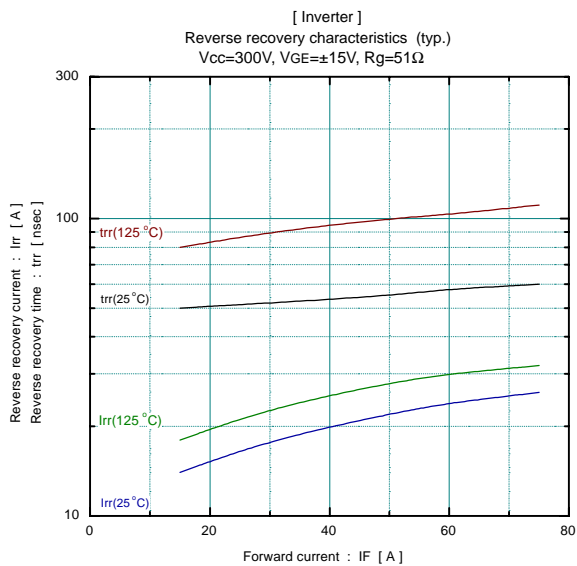
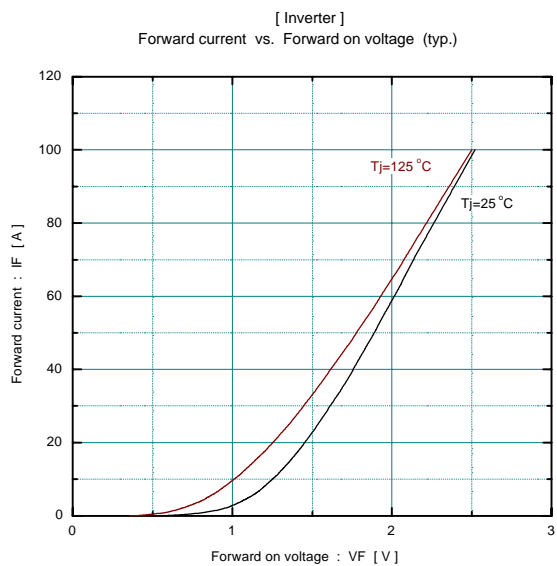

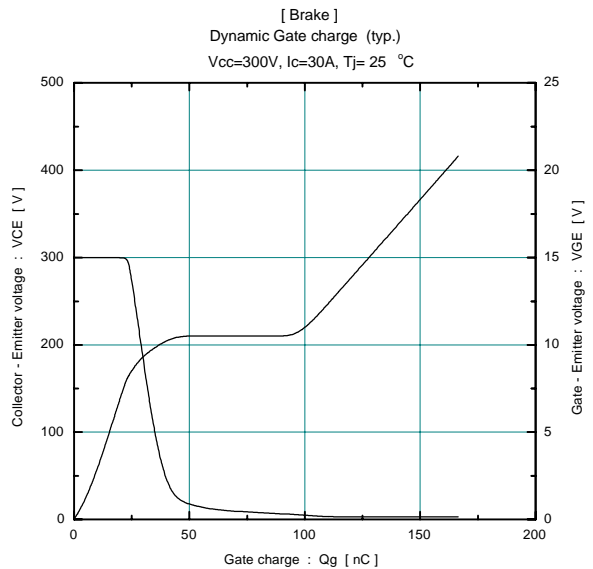
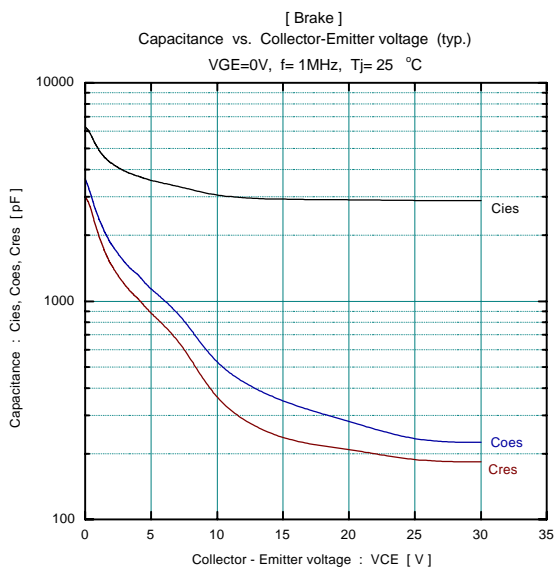
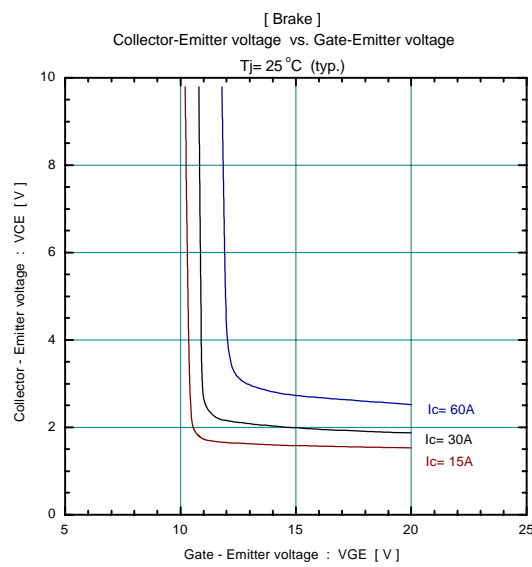
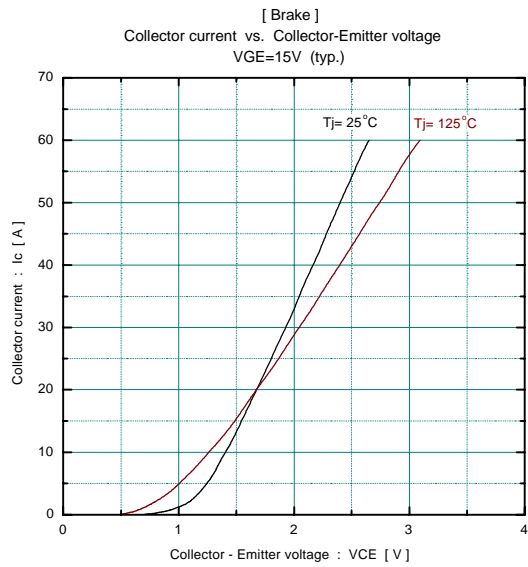
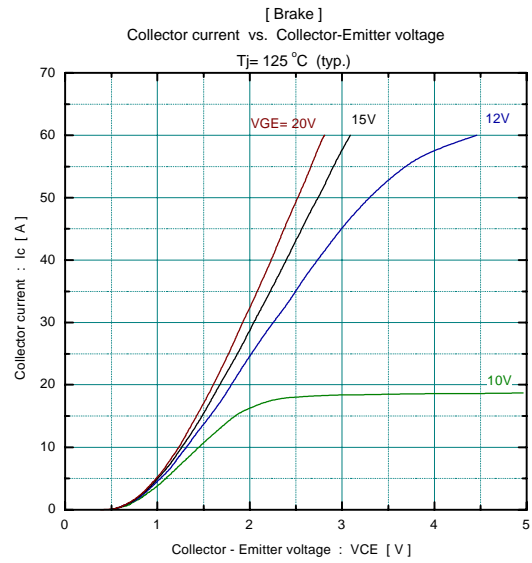
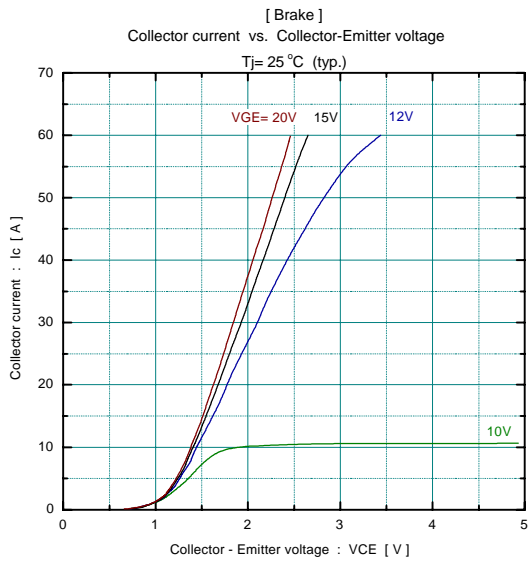

■ Outline Drawings, mm

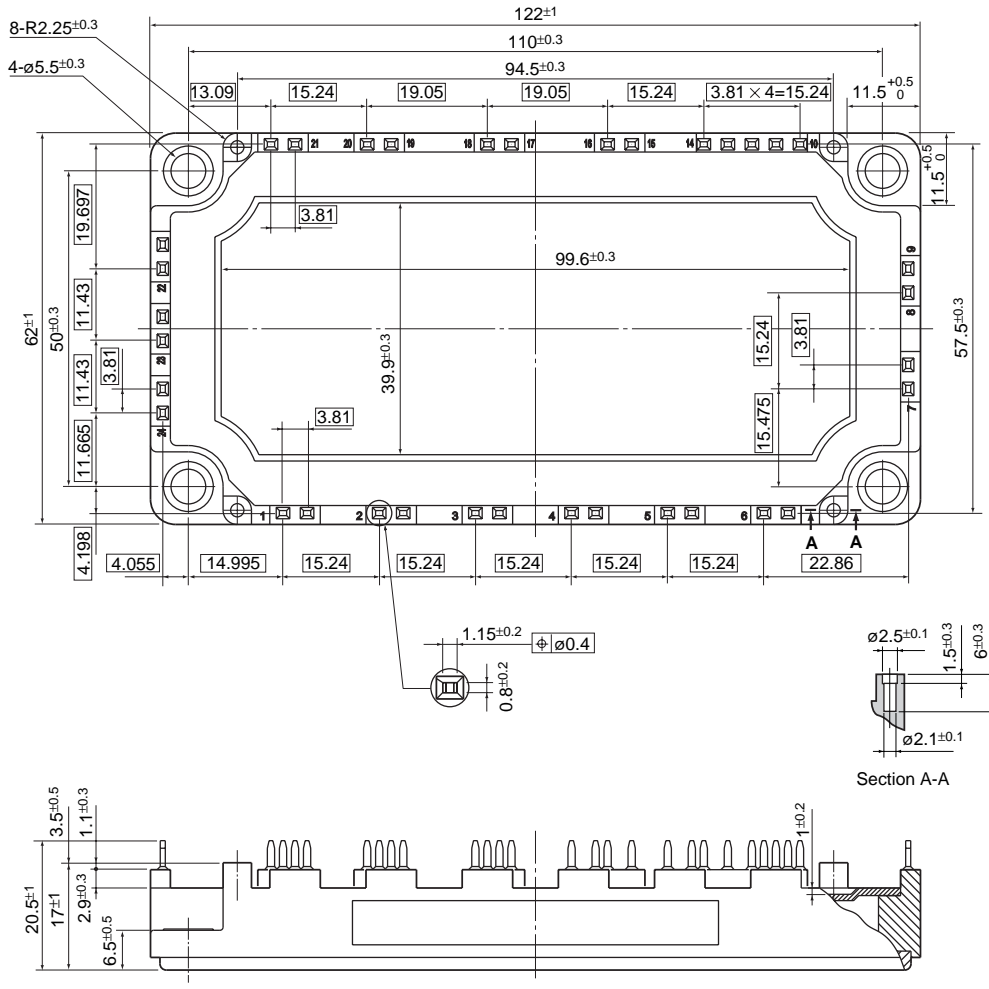

□ Shows theory dimensions

This datasheet has been download from:

[www.datasheetcatalog.com](http://www.datasheetcatalog.com)

Datasheets for electronics components.