

# 2SK3219-01MR

FUJI POWER MOS-FET

## N-CHANNEL SILICON POWER MOS-FET

### ■ Features

- High speed switching
- Low on-resistance
- No secondary breakdown
- Low driving power
- Avalanche-proof

### ■ Applications

- Switching regulators
- UPS (Uninterruptible Power Supply)
- DC-DC converters

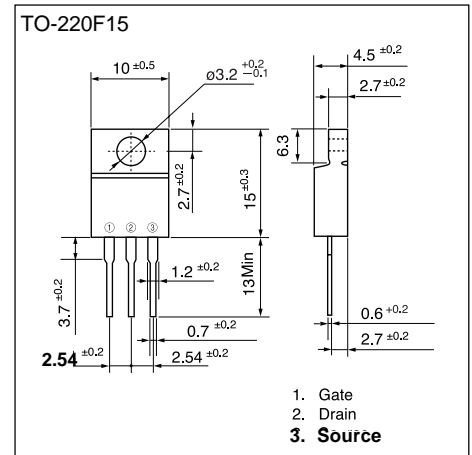

### ■ Maximum ratings and characteristic Absolute maximum ratings

● (Tc=25°C unless otherwise specified)

Item	Symbol	Rating	Unit	
Drain-source voltage	V <sub>DS</sub>	150	V	
Continuous drain current	I <sub>D</sub>	±40	A	
Pulsed drain current	I <sub>D(puls)</sub>	±160	A	
Gate-source voltage	V <sub>GS</sub>	±30	V	
Maximum Avalanche Energy	E <sub>AV*1</sub>	387	mJ	
Max. power dissipation	T <sub>a</sub> =25°C	P <sub>D</sub>	2.0	W
	T <sub>c</sub> =25°C	P <sub>D</sub>	70	W
Operating and storage temperature range	T <sub>ch</sub>	+150	°C	
	T <sub>stg</sub>	-55 to +150	°C	

\*1 L=420μH, V<sub>cc</sub>=24V

### ■ Equivalent circuit schematic

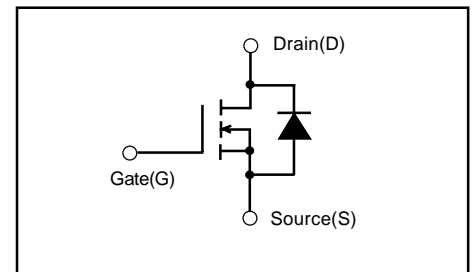

### ● Electrical characteristics (T<sub>c</sub> =25°C unless otherwise specified)

Item	Symbol	Test Conditions	Min.	Typ.	Max.	Units
Drain-source breakdown voltage	V <sub>(BR)DSS</sub>	I <sub>D</sub> =1mA V <sub>GS</sub> =0V	150			V
Gate threshold voltage	V <sub>GS(th)</sub>	I <sub>D</sub> =1mA V <sub>DS</sub> =V <sub>GS</sub>	2.5	3.0	3.5	V
Zero gate voltage drain current	I <sub>DSS</sub>	V <sub>DS</sub> =150V V <sub>GS</sub> =0V	T <sub>ch</sub> =25°C	1	100	μA
			T <sub>ch</sub> =125°C	0.1	0.5	mA
Gate-source leakage current	I <sub>GSS</sub>	V <sub>GS</sub> =±30V V <sub>DS</sub> =0V		10	100	nA
Drain-source on-state resistance	R <sub>DS(on)</sub>	I <sub>D</sub> =20A V <sub>GS</sub> =10V		37	43	mΩ
Forward transconductance	g <sub>fs</sub>	I <sub>D</sub> =20A V <sub>DS</sub> =25V	12.5	25.0		S
Input capacitance	C <sub>iss</sub>	V <sub>DS</sub> =25V		2650	3980	pF
Output capacitance	C <sub>oss</sub>	V <sub>GS</sub> =0V		550	830	
Reverse transfer capacitance	C <sub>rss</sub>	f=1MHz		240	360	
Turn-on time t <sub>on</sub>	td(on)	V <sub>CC</sub> =48V I <sub>D</sub> =40A V <sub>GS</sub> =10V		21	32	ns
	t <sub>r</sub>			95	142	
Turn-off time t <sub>off</sub>	td(off)	R <sub>GS</sub> =10Ω		115	173	
	t <sub>f</sub>			60	90	
Avalanche capability	I <sub>AV</sub>	L=100μH T <sub>ch</sub> =25°C	40			A
Diode forward on-voltage	V <sub>SD</sub>	I <sub>F</sub> =40A V <sub>GS</sub> =0V T <sub>ch</sub> =25°C		0.97	1.46	V
Reverse recovery time	t <sub>rr</sub>	I <sub>F</sub> =40A V <sub>GS</sub> =0V		180		ns
Reverse recovery charge	Q <sub>rr</sub>	-di/dt=100A/μs T <sub>ch</sub> =25°C		1.30		μC

### ● Thermal characteristics

Item	Symbol	Test Conditions	Min.	Typ.	Max.	Units
Thermal resistance	R <sub>th(ch-c)</sub>	channel to case			1.79	°C/W
	R <sub>th(ch-a)</sub>	channel to ambient			62.5	°C/W

Characteristics

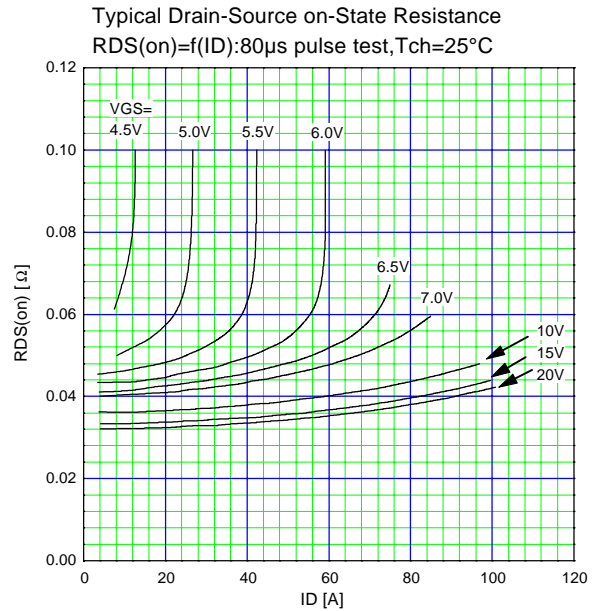
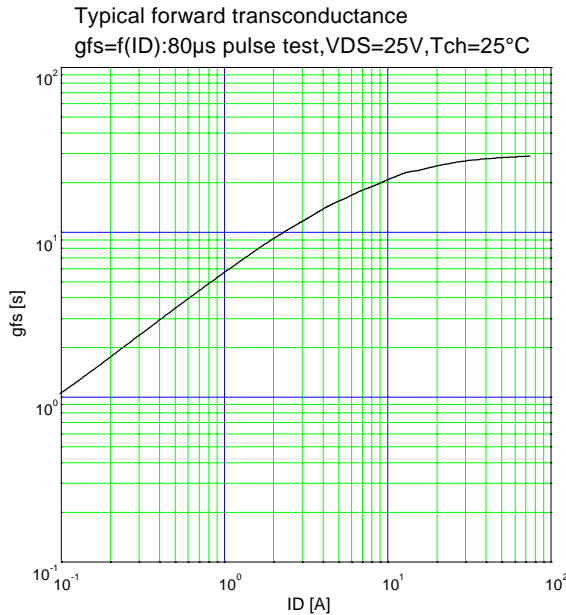
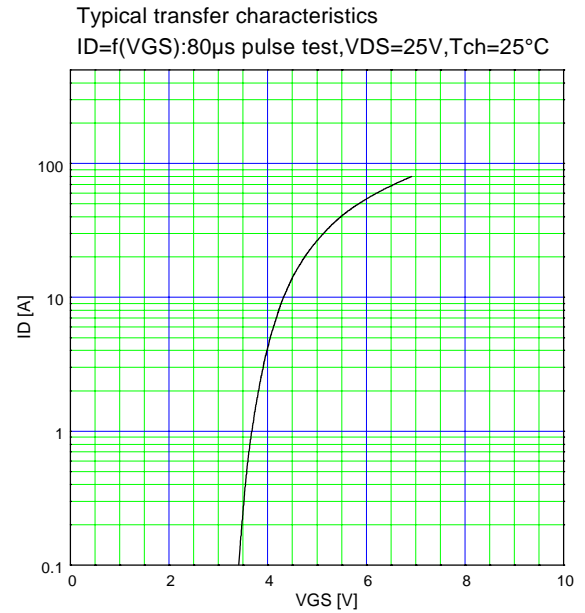
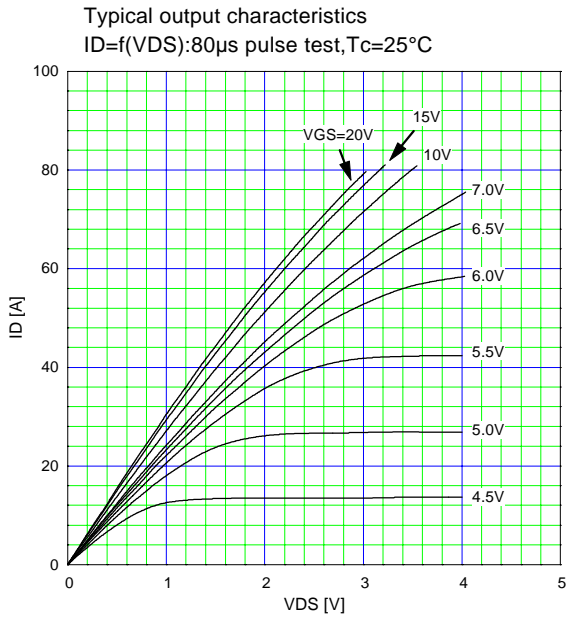
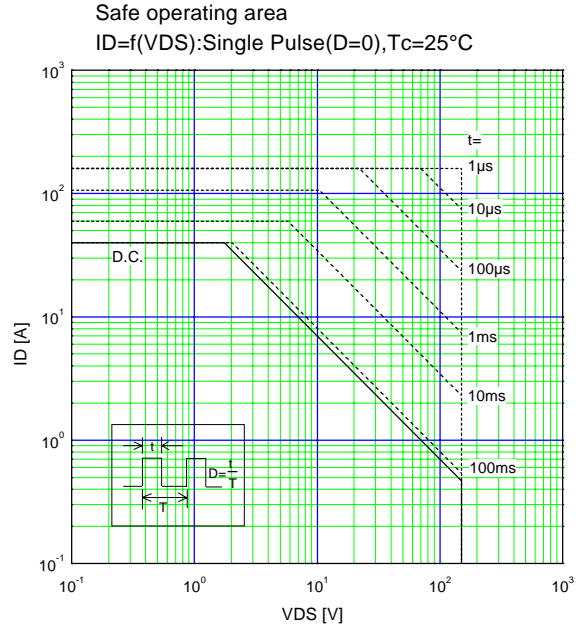
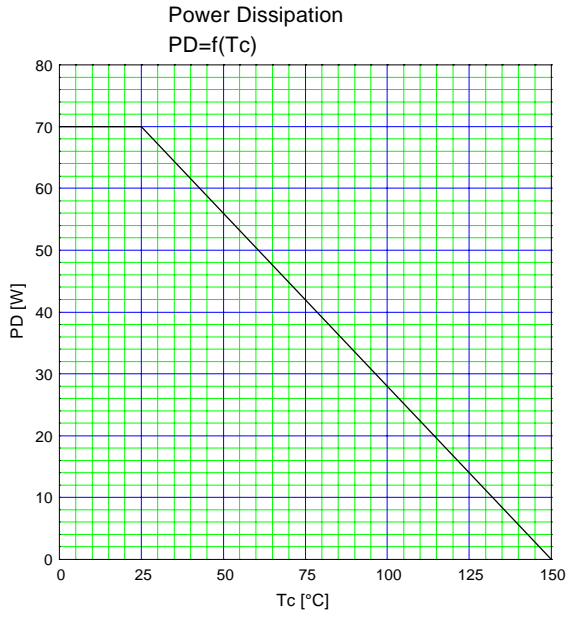

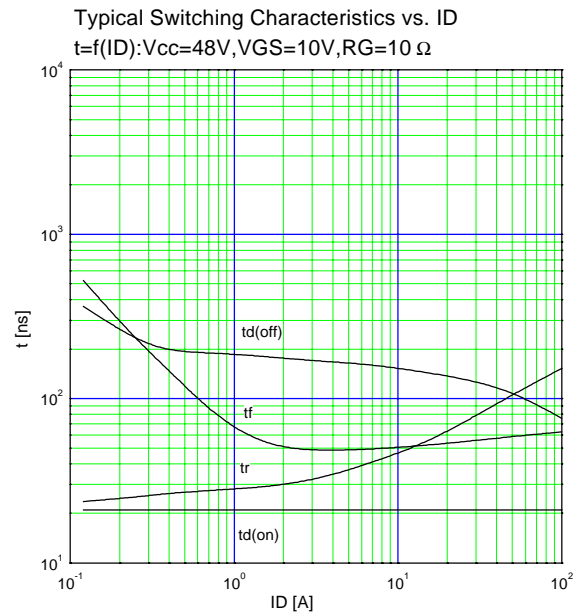
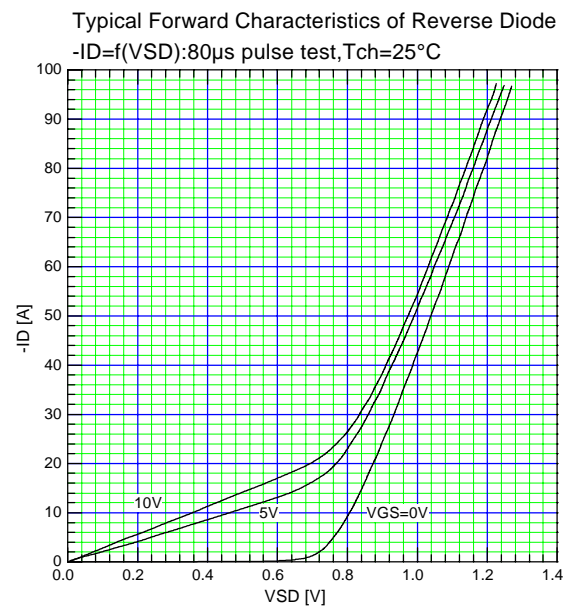
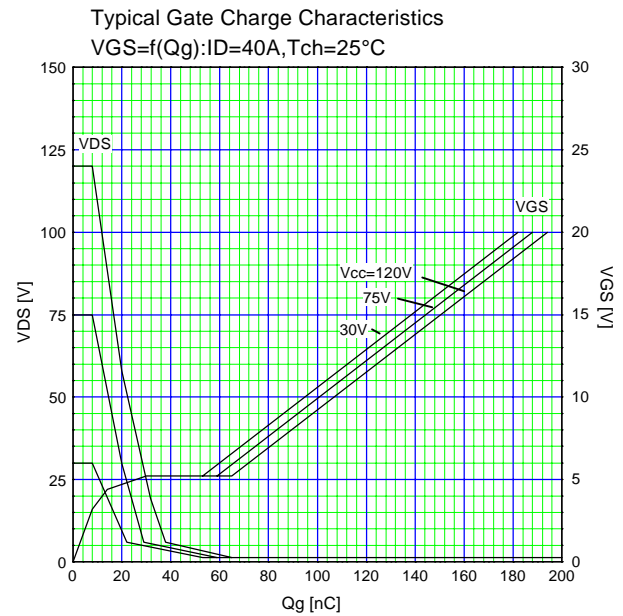
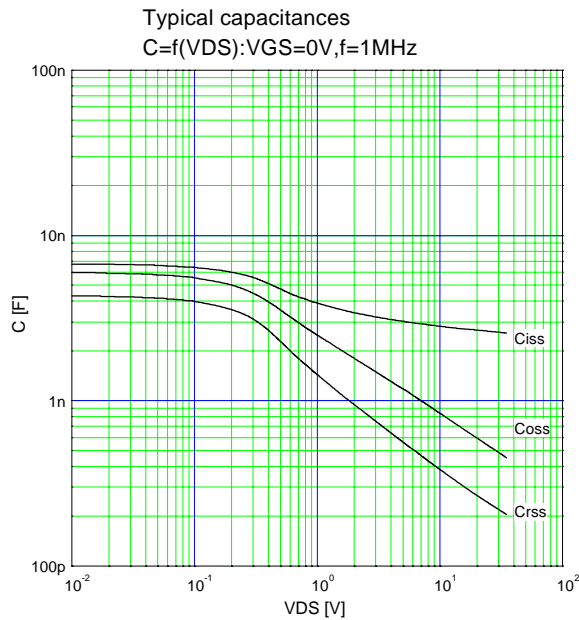
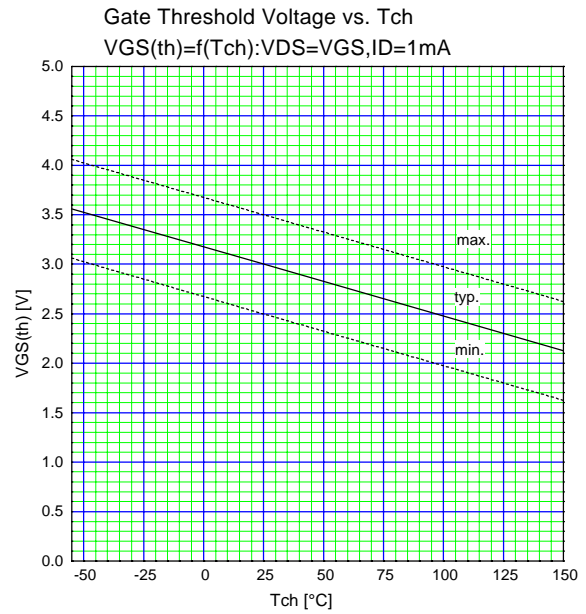
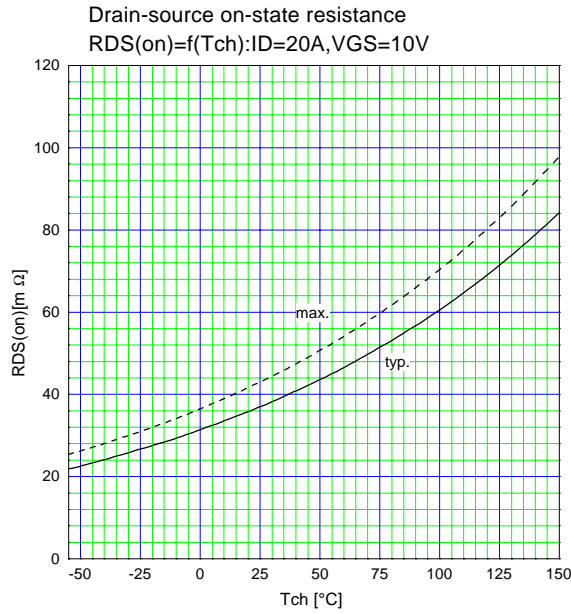

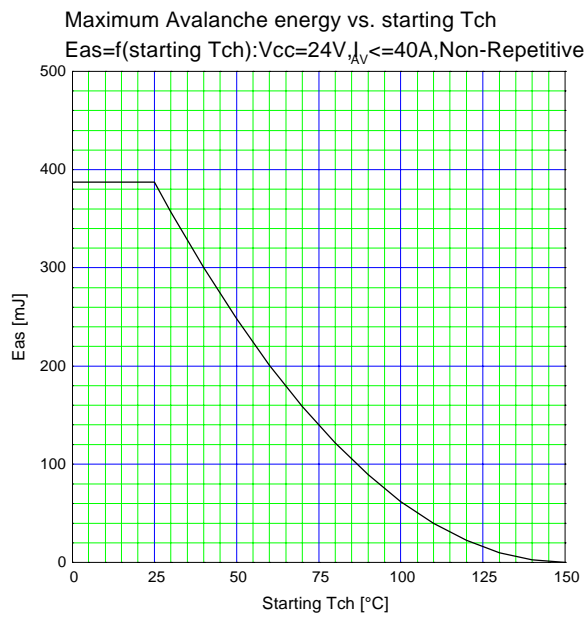
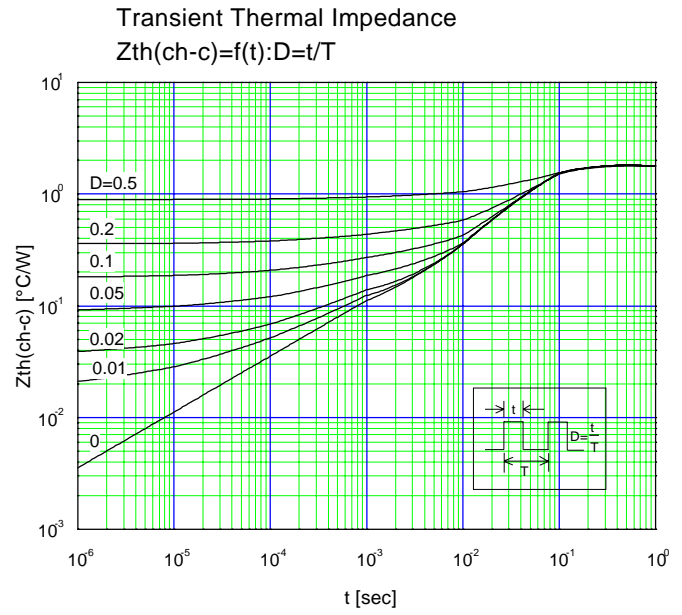
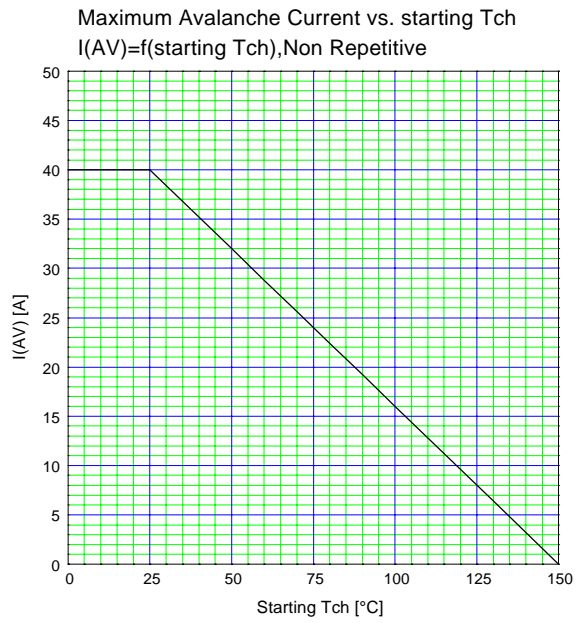

This datasheet has been download from:

[www.datasheetcatalog.com](http://www.datasheetcatalog.com)

Datasheets for electronics components.