

## IGBT MODULE ( P-Series )

### ■ Features

- Square SC SOA at  $10 \times I_C$
- Simplified Parallel Connection
- Narrow Distribution of Characteristics
- High Short Circuit Withstand-Capability

### ■ Applications

- High Power Switching
- A.C. Motor Controls
- D.C. Motor Controls
- Uninterruptible Power Supply

### ■ Outline Drawing

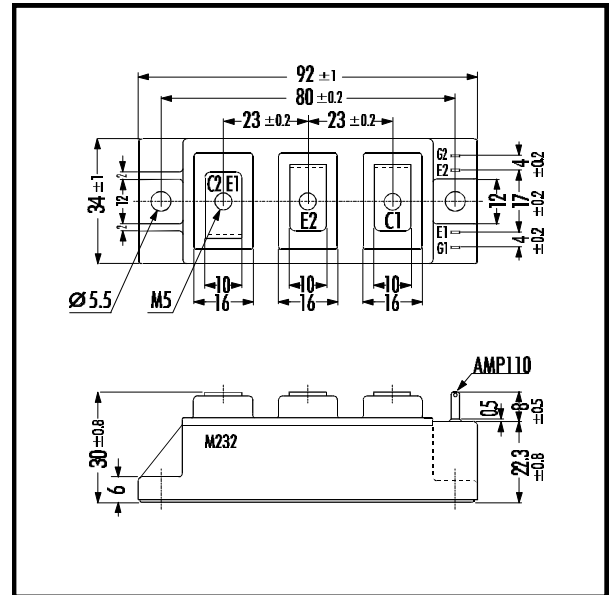

### ■ Maximum Ratings and Characteristics

#### • Absolute Maximum Ratings ( $T_c=25^\circ\text{C}$ )

Items	Symbols	Ratings	Units		
Collector-Emitter Voltage	$V_{CES}$	1400	V		
Gate -Emitter Voltage	$V_{GES}$	$\pm 20$	V		
Collector Current	Continuous $T_c=25^\circ\text{C}$	75	A		
		Continuous $T_c=80^\circ\text{C}$		50	
	1ms $T_c=25^\circ\text{C}$	$I_C$ PULSE		150	
		1ms $T_c=80^\circ\text{C}$		$-I_C$	50
				$-I_C$ PULSE	100
Max. Power Dissipation	$P_C$	400	W		
Operating Temperature	$T_j$	+150	$^\circ\text{C}$		
Storage Temperature	$T_{stg}$	-40 ~ +125	$^\circ\text{C}$		
Isolation Voltage	A.C. 1min. $V_{is}$	2500	V		
Screw Torque	Mounting *1	3.5	Nm		
	Terminals *2	3.5			

Note: \*1:Recommendable Value; 2.5 - 3.5 Nm (M5)

### ■ Equivalent Circuit

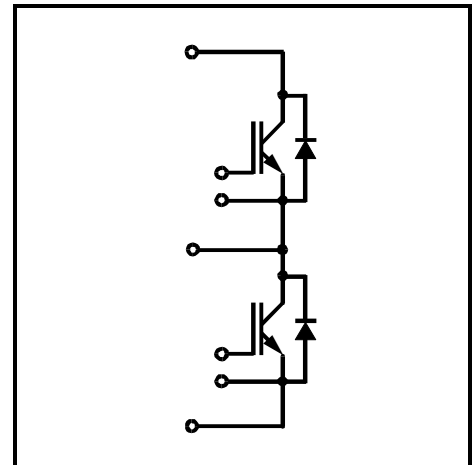

#### • Electrical Characteristics ( at $T_f=25^\circ\text{C}$ )

Items	Symbols	Test Conditions	Min.	Typ.	Max.	Units
Zero Gate Voltage Collector Current	$I_{CES}$	$V_{GE}=0V$ $V_{CE}=1400V$			1.0	mA
Gate-Emitter Leakage Current	$I_{GES}$	$V_{CE}=0V$ $V_{GE}=\pm 20V$			200	$\mu\text{A}$
Gate-Emitter Threshold Voltage	$V_{GE(th)}$	$V_{GE}=20V$ $I_C=50\text{mA}$	6.0	8.0	9.0	V
Collector-Emitter Saturation Voltage	$V_{CE(sat)}$	$T_f=25^\circ\text{C}$ $V_{GE}=15V$ $I_C=50\text{A}$		2.7	3.0	V
		$T_f=125^\circ\text{C}$ $V_{GE}=15V$ $I_C=50\text{A}$		3.3		
Input capacitance	$C_{ies}$	$V_{CE}=0V$		5000		pF
Output capacitance	$C_{oes}$	$V_{CE}=10V$		750		
Reverse Transfer capacitance	$C_{res}$	$f=1\text{MHz}$		330		
Turn-on Time	$t_{ON}$	$V_{CC}=600V$			1.2	$\mu\text{s}$
	$t_r$	$I_C=50\text{A}$			0.6	
Turn-off Time	$t_{OFF}$	$V_{GE}=\pm 15V$			1.0	
	$t_f$	$R_G=2,4\Omega$			0.3	
Diode Forward On-Voltage	$V_F$	$I_F=50\text{A}$ $V_{GE}=0V$		2.4	3.3	V
Reverse Recovery Time	$t_{rr}$	$I_F=50\text{A}$			350	ns

#### • Thermal Characteristics

Items	Symbols	Test Conditions	Min.	Typ.	Max.	Units
Thermal Resistance	$R_{th(f-c)}$	IGBT			0.31	$^\circ\text{C/W}$
	$R_{th(f-e)}$	Diode			0.66	
	$R_{th(c-f)}$	With Thermal Compound		0.05		

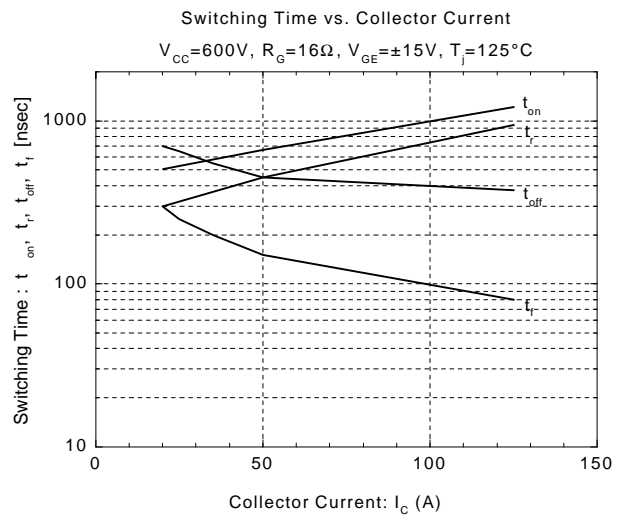
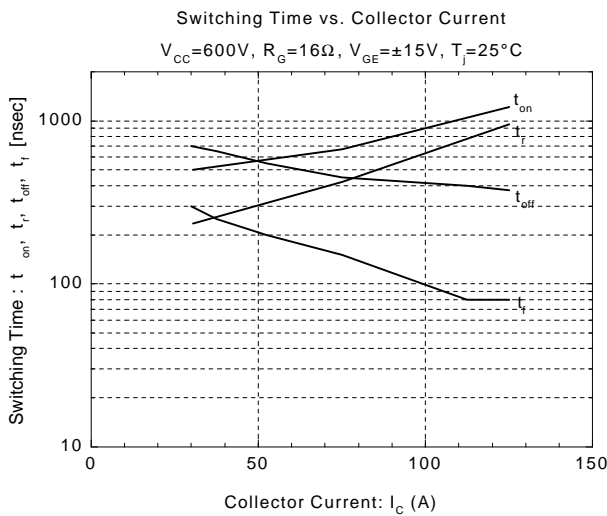
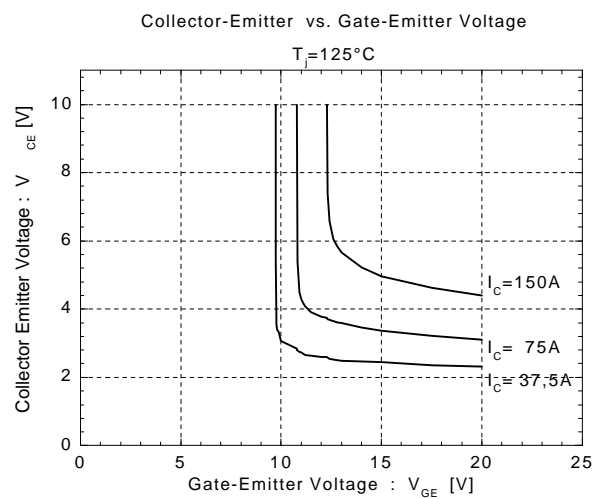
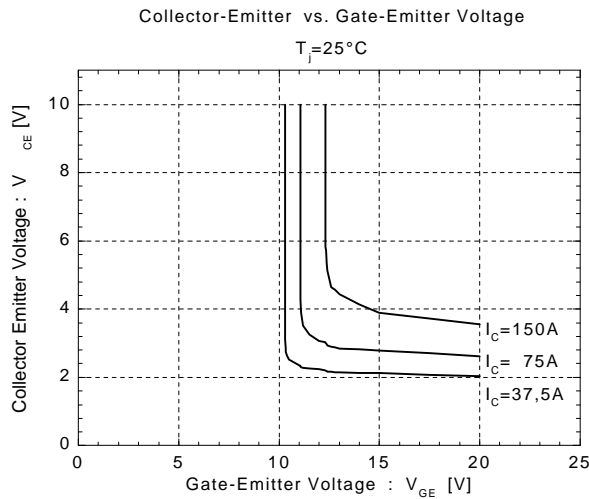
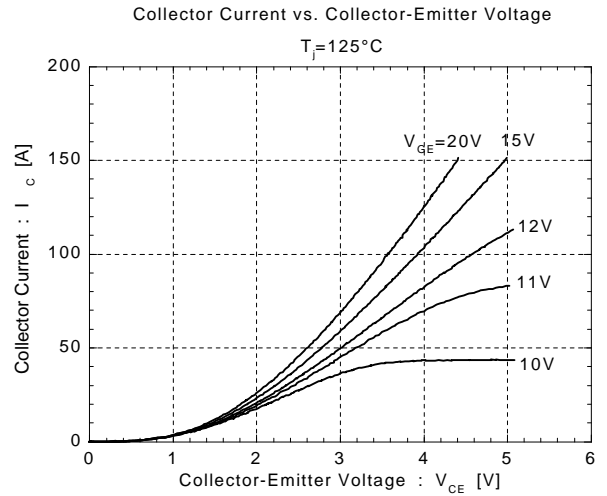
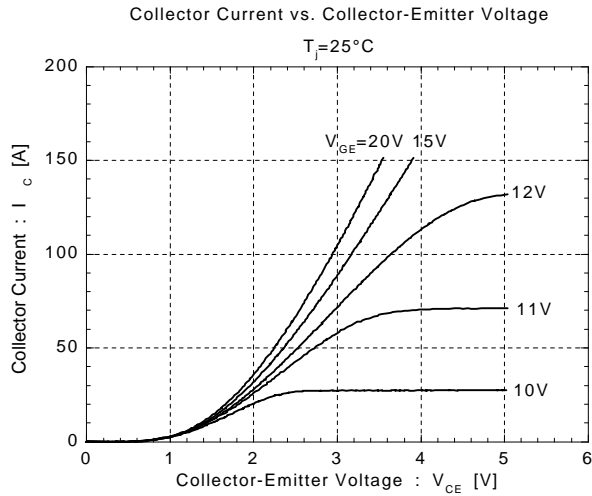

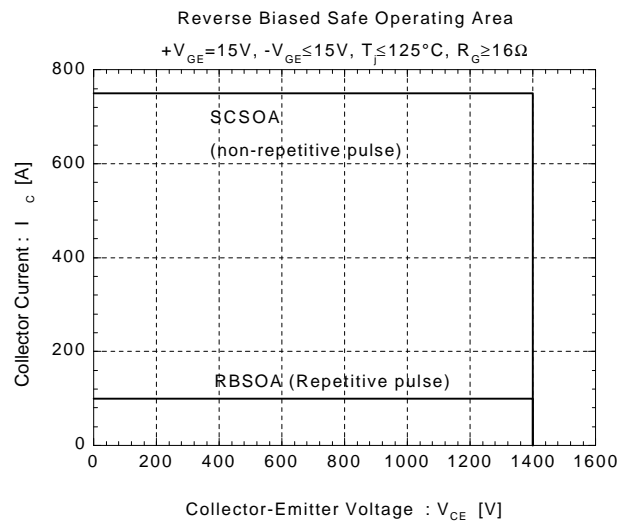
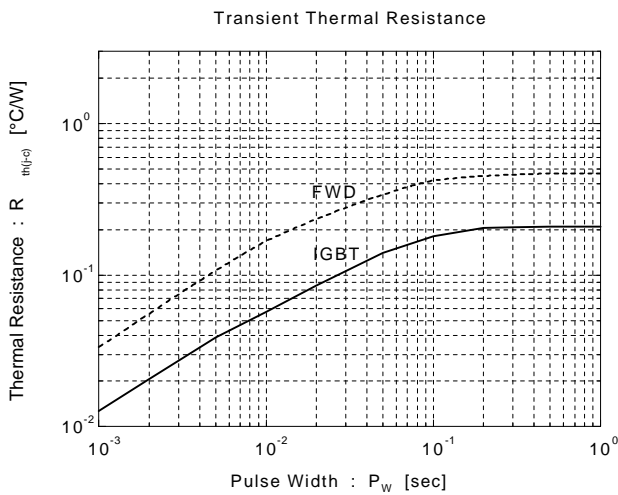
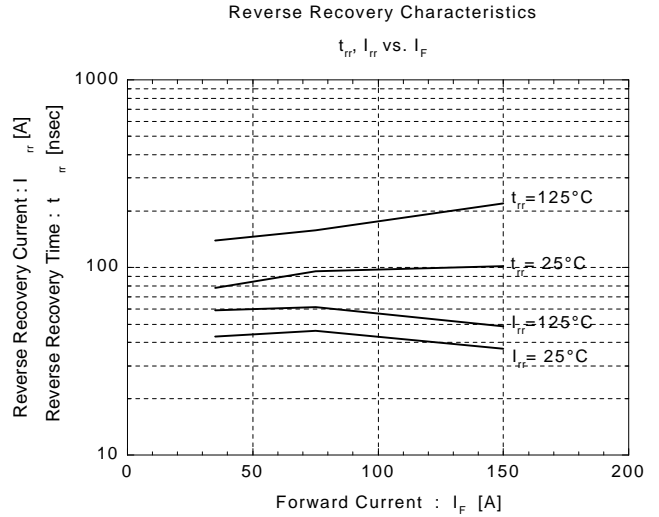
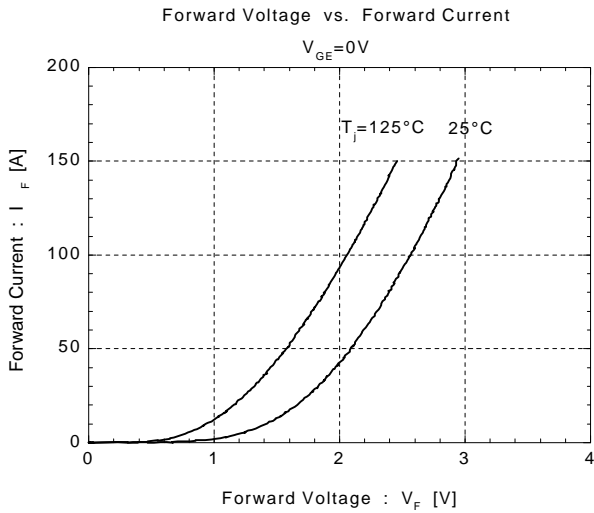
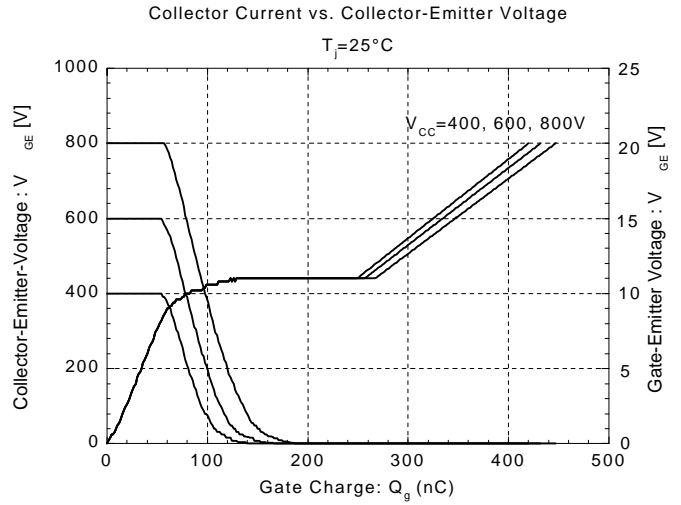
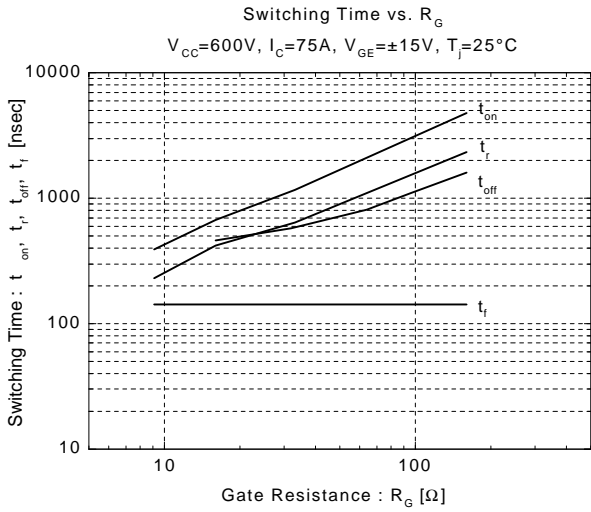

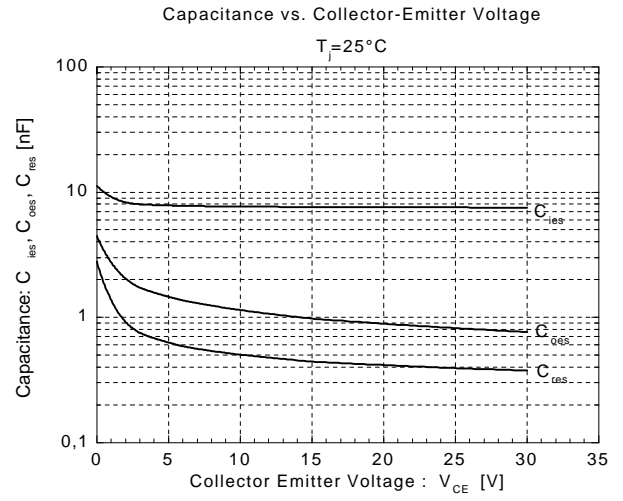
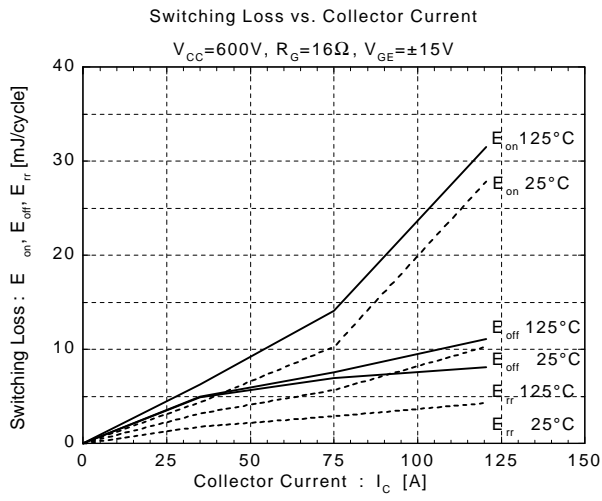

For more information, contact:

**Collmer Semiconductor, Inc.**

P.O. Box 702708

Dallas, TX 75370

972-233-1589

972-233-0481 Fax

<http://www.collmer.com>

This datasheet has been download from:

[www.datasheetcatalog.com](http://www.datasheetcatalog.com)

Datasheets for electronics components.